



MonoEquip.com

MONO Harmony Deck Oven

EN

Installation and Operation Manual



Product Version

- USA specification
- Modular decks
- Classic controller

Enter Serial Numbers here

Deck 1
Deck 2
Deck 3
Deck 4
Deck 5
Fan (If fitted)

In the event of an enquiry please quote these serial numbers.



DECLARATION OF CONFORMITY

We hereby declare that this machine complies with the essential health and safety requirements of :-

- The Machinery Directive 2006 / 42 / EC
- The Low voltage Directive 2006 / 95 / EC
- The requirements of the Electromagnetic Compatibility Directive 2004 / 108EC, 91 / 263 / EEC, 92 / 31 / EEC
- The General Safety of Machinery and food processing Standards applicable
- Materials and Articles intended to come into contact with food - Regulation (EC) No. 1935 / 2004
- Good manufacturing practice for Materials intended to come into contact with food - Regulation (EC) No. 2023 / 2006

Signed	
D. Osmundsen – Quality and Conformance Manager	

Date	
-------------	--

Machine FG Code.		Machine Serial No.	
-------------------------	--	---------------------------	--

A technical construction file for this machine is retained at the following address:

MONO EQUIPMENT
 Queensway,
 Swansea West Industrial Park,
 Swansea
 SA5 4EB
 UK

MONO EQUIPMENT is a business name of **AFE GROUP Ltd**
 Registered in England No.3872673 VAT registration No.923428136

Registered office: Unit 35,
 Bryggen Road,
 North Lynn Industrial Estate,
 Kings Lynn Norfolk,
 PE30 2HZ

Warning and Information Labels



Warning label, to reduce risk of fire or electric shock. Do not remove the cover (or back). No user serviceable parts inside. Repair should be done by authorized personnel only.



Warning label, to warn of hot surfaces.

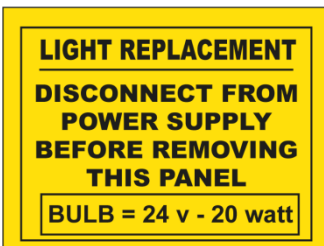

Light replacement power warning.



Multiple Supply Cord Information.

Safety Symbols

The following safety symbols are used throughout this product manual. Before using your new equipment, read the instructions carefully and pay special attention to the information marked with the following symbols:

**DANGER**

Indicates an immediate hazard with a high risk of death or serious physical injury if not avoided.

**WARNING**

Indicates a potential hazard with a medium risk that could result in death or serious physical injury if not avoided.

**CAUTION**

Indicates a hazardous situation that could result in minor or moderate injury if not avoided.

Electrical Safety Notice



Electrical safety and advice regarding supplementary electrical protection

Commercial kitchens and food service areas are environments where electrical appliances may be located close to liquids, operate in and around damp conditions or where restricted movement for installation and service is evident.

The appliance installation and periodic inspection should only be undertaken by a qualified, skilled, and competent electrician and connected to the correct power supply suitable for the load as stipulated by the appliance data label.

The electrical installation and connections should meet the mandatory requirements of the local electrical wiring regulations and any safety guidelines.

We recommend:

- Supplementary electrical protection with the use of a residual current device (RCD)
- Fixed wiring appliances should also incorporate a locally situated switch disconnector to connect to, which is easily accessible for switching off and safe isolation purposes. The switch disconnector must meet the specification requirements of IEC 60947.

Your attention is drawn to the following:

BS 7671:2018 – Guidance Note 8 – 8.13: Other locations of increased safety risk

It is recognized that there may be locations of increased risk of electrical shock other than those specifically addressed in Part 7 of BS 7671. Examples of such locations could include laundries, where washing and drying machines are nearby, and water is present, and commercial kitchens with stainless steel units where, once again, water is present. Where, because of the perception of additional risks being likely, the installation designer decides that an installation or location warrants further protective measures, the options available include:

- Automatic Disconnection of Supply (ADS) using a residual current device having a residual operating current not exceeding 30 mA;
- Supplementary protective equipotential bonding; and
- Reduction of maximum fault clearance time.

The provision of RCDs and supplementary bonding must be specified by the host organization's appointed installation designer or electrical contractor and installed by a suitably qualified and competent electrician to comply with Regulations 419.2 and 544.2.



WARNING

- The supply to this machine must be protected by a 30mA-rated Type 'A' Residual Current Device (RCD).
 - Before installation, it is recommended that a qualified and competent electrician first tests the electrical outlet for electrical safety.
-

Water Leak Safety Notice

**WARNING**

- **Take action immediately to get a water leak fixed and prevent death or serious injury from electrocution.**
-

It is essential to regularly check for any signs of a water leak from an oven installation. If there is evidence of a water leak, do not ignore it. Immediately report it to a manager or as applicable to your organization.

Furthermore:

- Disconnect or completely isolate the oven from the electrical supply (see **Emergency Instructions** section on page **20**).
- Place an out-of-service notice on the oven.
- Contact your oven supplier or MONO Equipment for technical assistance.

Ovens must be maintained and serviced at appropriate intervals to ensure the oven operates at optimum levels. See the Maintenance section on page **45**.

General Notices

**CAUTION****■ Users with Implantable Cardioverter Defibrillators and Pacemakers**

- Several common types of devices and machinery may interfere with implantable cardioverter defibrillators (ICDs) and pacemakers, including mobile phones, headphones, radios, machinery, and magnets.
 - The electromagnetic waves generated by these devices can keep your ICD or pacemaker from functioning correctly. Try to avoid them, or at least minimize your exposure to them.
 - Your healthcare professional can advise you about specific devices and machinery to avoid.
-

**NOTICES****■ Warranty information**

- Ambient working temperatures for electrical components, such as solenoid switches, circuit breakers and motors, should not exceed 40 °C (115 °F). Manufacturers of these, and other electrical components, advise that any ambient temperature above this affects the functionality of the components. Any related guarantees become void.
- It is the owners' responsibility to ensure adequate ventilation is provided. Any component malfunctioning during the guarantee period found to have been subjected to excessive humidity or ambient working temperatures is not covered by the component manufacturer's or MONO Equipment's product warranty.
- Failure to adhere to the cleaning and maintenance instructions detailed in this User Manual also could affect the warranty of this machine.
- Visit the [MONO Parts and Labour Warranty page](#) for further information.

■ Continuous improvements

- Our policy is to improve our machines continuously, and we reserve the right to change specifications without prior notice.

■ Engineers/Electricians-only sections of the User Manual

- Technical sections of this User Manual are for suitably experienced and qualified persons (SEQP) only. Customers must never make any modifications or repairs to MONO's machines.
-

Engineers Notice

If these numbers appear in the temperature window, please check the following:

- 888** Indicates that the control board temperature is above 80°C (176°F). Using oven gloves, check that the cooling fan entry is not blocked.

 - 999** Indicates there is a problem with the thermocouple. Check for connection problems or a faulty thermocouple.
-

Contents

	Page
1. Introduction	11
2. Overall Dimensions	12
Overall dimensions	12
3. Specifications	13
Electrical specifications	13
Environmental specifications	13
Mechanical specifications	14
Deck oven dimensions	15
4. Safety	18
Safety messages	18
Emergency instructions	20
5. Installation	21
General	21
Electrical connections	21
Fit earth straps (part no. 158-25-11200)	21
Fit the tile retaining brackets (part no. 257-06-00015)	22
Water supply requirements	22
Water system setup procedure	23
Exhaust Connections (if canopy fitted)	24
6. Before First Use of the Oven	26
Operating conditions	26
Baking tile 'seasoning' instructions	26
Baking principles	28
7. Operating Instructions	30
Basic operation	31
Firmware update using the iButton	34
Operating the oven	35
Setting the day and time	36
Setting the 7-day timer	37
Setup mode	38
8. Cleaning	41
Daily cleaning instructions	41
Weekly cleaning instructions	41
9. Troubleshooting	42

10. Service 43

 Oven spares 43

 Service Information 44

 Disposal 44

11. Maintenance 45

 General maintenance 45

 Light bulb replacement 45

12. Oven Electrics 47

 Electrical drawings 53

 Electrical panel main components 60

13. Warning and Information Labels 65

1. Introduction

The electric modular Deck Oven is an easy-to-use practical, good-looking oven, giving an excellent heat recovery rate and an even bake across a wide range of bread and confectionery products.

■ Good looking and completely reliable

Conceived with the no-nonsense requirements of both the independent and in-store baker in mind, designed to be visually pleasing and give reliable service for many years visually. This oven will more than satisfy the most discerning customer.

■ Top-quality specification

The external and internal contact surfaces are stainless steel.

Each modular deck has one or more durable reinforced tiles, high-grade insulation, and high-temperature ceramic sealant to make the oven more efficient.

The oven comes with a patented integral steaming system, which reduces energy consumption and the overall size of the oven. The system produces natural steam with the advantages of spray steam. Pre-steam is also available to reduce the effects of long loading times. No drainage is required.

Classic ovens are supplied with **LED** displays. All programmable parameters have separate indicators for easy programming and extra bake time, if required. An energy saving 7-day timer is also standard.

The simplified electrical circuits aid reliability with overheat protection (on controllers and oven) to ensure long life of controllers, all housed in splash-proof electrical enclosures. The lights are low voltage, sealed from the chamber and easily accessed from outside the oven.

An “i” button can be used to upgrade firmware without the need of dismantling the panels.

Fitted with a choice of hinged easy to clean double-glazed doors (using low energy-loss reflective glass for high visibility) or metal doors, means low energy consumption and the high kW rating gives good recovery. (0-100% heating available both top and bottom).

As it is our policy to improve our machines continuously, we reserve the right to change specifications without prior notice.

2. Overall Dimensions

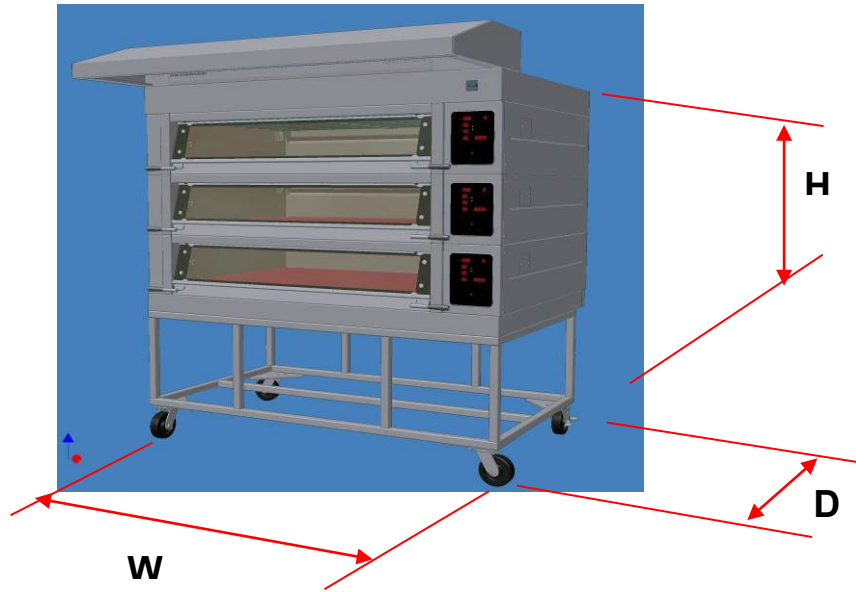

NOTE

■ All dimensions are approximate and do not include the optional canopy (see **pages 24 and 25**).

Overall dimensions

Specification	1-pan wide	2-pans wide	3-pans wide
Width	955 mm (37½ in.)	1416 mm (55¾ in.)	1890 mm (74½ in.)
Depth	1312 mm (51½ in.)		
Height (2 decks) ⁽¹⁾	2020 mm (79½ in.)		
Height (3 decks) ⁽¹⁾	2020 mm (79½ in.)		
Height (4 decks) ⁽¹⁾	2020 mm (79½ in.)		
Height (5 decks) ⁽¹⁾	2140 mm (84¼ in.)		

⁽¹⁾ Including the base and top finishing. See **pages 15 and 16** for dimensional diagrams.

3. Specifications

Electrical specifications



- WARNING**
- An electrical socket must be protected by a 30mA-rated Type ‘A’ Residual Current Device (RCD) before installation and commissioning of the oven.
 - Always fit a wall mounted isolator switch to isolate the oven from the electrical supply completely. The isolator must be visible, clearly labelled, and easily accessible by an operator.
 - Always check the electrical ratings on the nameplate before connecting power.

The electrical loadings in **Table 1** and **Table 2** are for an individual deck module, not the complete oven.

Table 1: Electrical loading per standard-sized modular deck

Supply	3-pans wide	2-pans wide	1-pan wide
3 phase (3 wires+ground), 220 Vac (60 Hz)	8.85 kW, 24 Amp	5.93 kW, 18 Amp	3.0 kW, 9 Amp
3 phase (3 wires+ground), 208 Vac (60 Hz)	7.90kW, 22 Amp	5.31 kW, 17 Amp	2.7 kW, 8.7Amp
3 phase (3 wires+ground), 480 Vac (60 Hz)	8.78 kW, 12.4 Amp	5.86 kW, 8.2 A.	4.9 kW, 7 Amp

Table 2: Electrical loading per compact modular deck

Overload protection	3 pans-wide	2 pans-wide	1-pan wide
Each modular deck	20 Amps	20 Amps	20 Amps



- NOTE**
- Whenever connecting power to the oven, eight minutes must elapse before the oven’s steam function can be used. The bottom elements require enough time to heat up for steaming. This waiting time applies even if the power is disconnected and connected again, and the oven is still hot.

Environmental specifications

The noise level is less than 80 dB.

Mechanical specifications

Table 3: Weights for standard-size deck oven

Specification	Nominal trays wide	Modular decks	Weight ⁽²⁾	
			Lbs	Kg
Total oven weight (including base frame)	3	3	2345	1064
	2	3	1569	711
	1	3	(1)	(1)
Weight per oven chamber module	3	-	575	261
	2	-	421	191.5
	1	-	(1)	(1)
Weight per oven canopy module	3	-	38	17
	2	-	31	14
	1	-	(1)	(1)
Weight per fan module	3	-	62	28
	2	-	62	28
	1	-	(1)	(1)
Weight of product (maximum) per deck	3	-	131	60
	2	-	86	39
	1	-	(1)	(1)

(1) To be advised. Contact MONO Equipment for information.

(2) All weights are approximate.

Deck oven dimensions

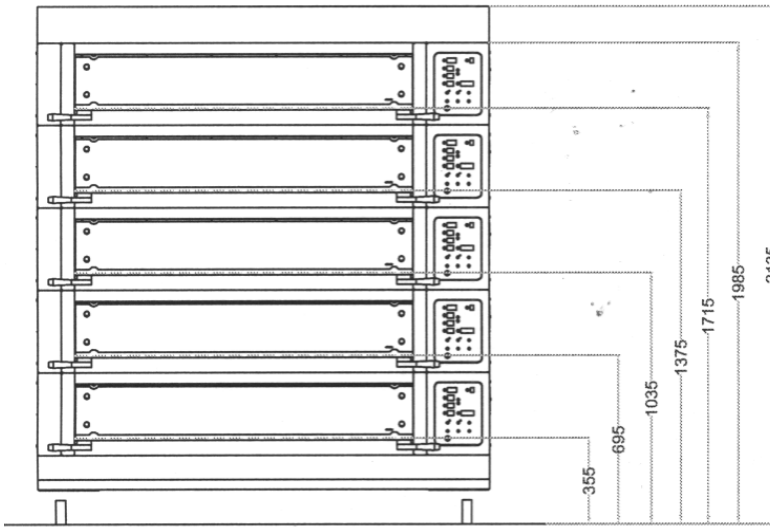

**5 DECK OVEN
DECK PLATE HEIGHTS**

**4 DECK OVEN
DECK PLATE HEIGHTS**

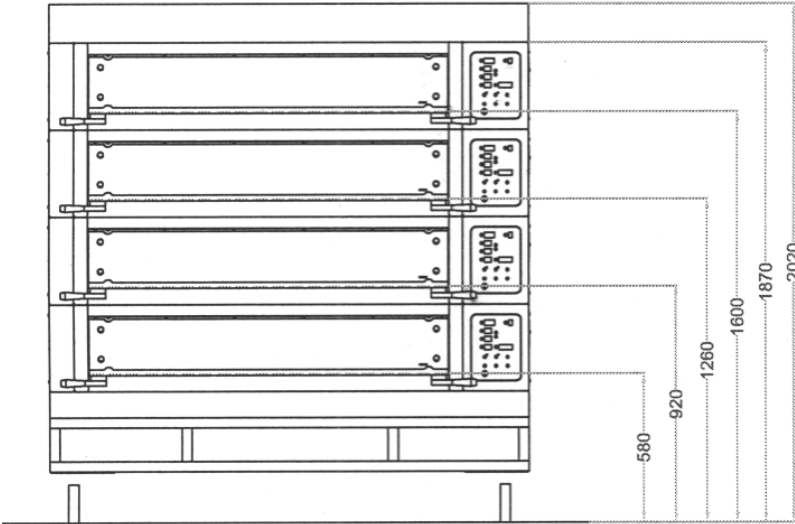

**3 DECK OVEN
DECK PLATE HEIGHTS**

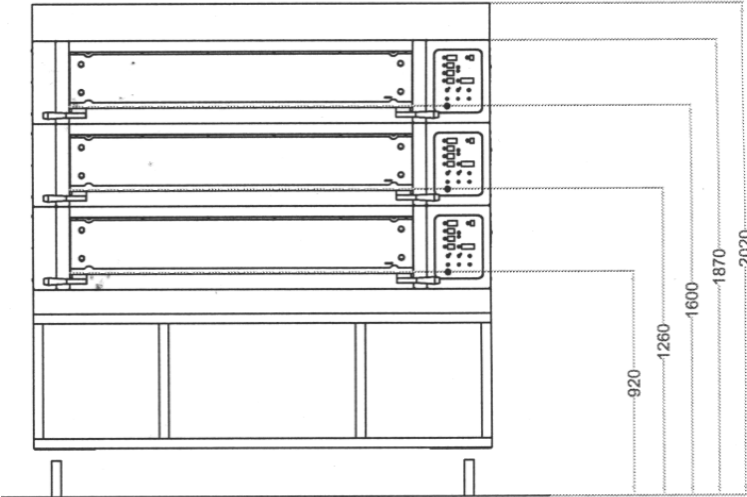

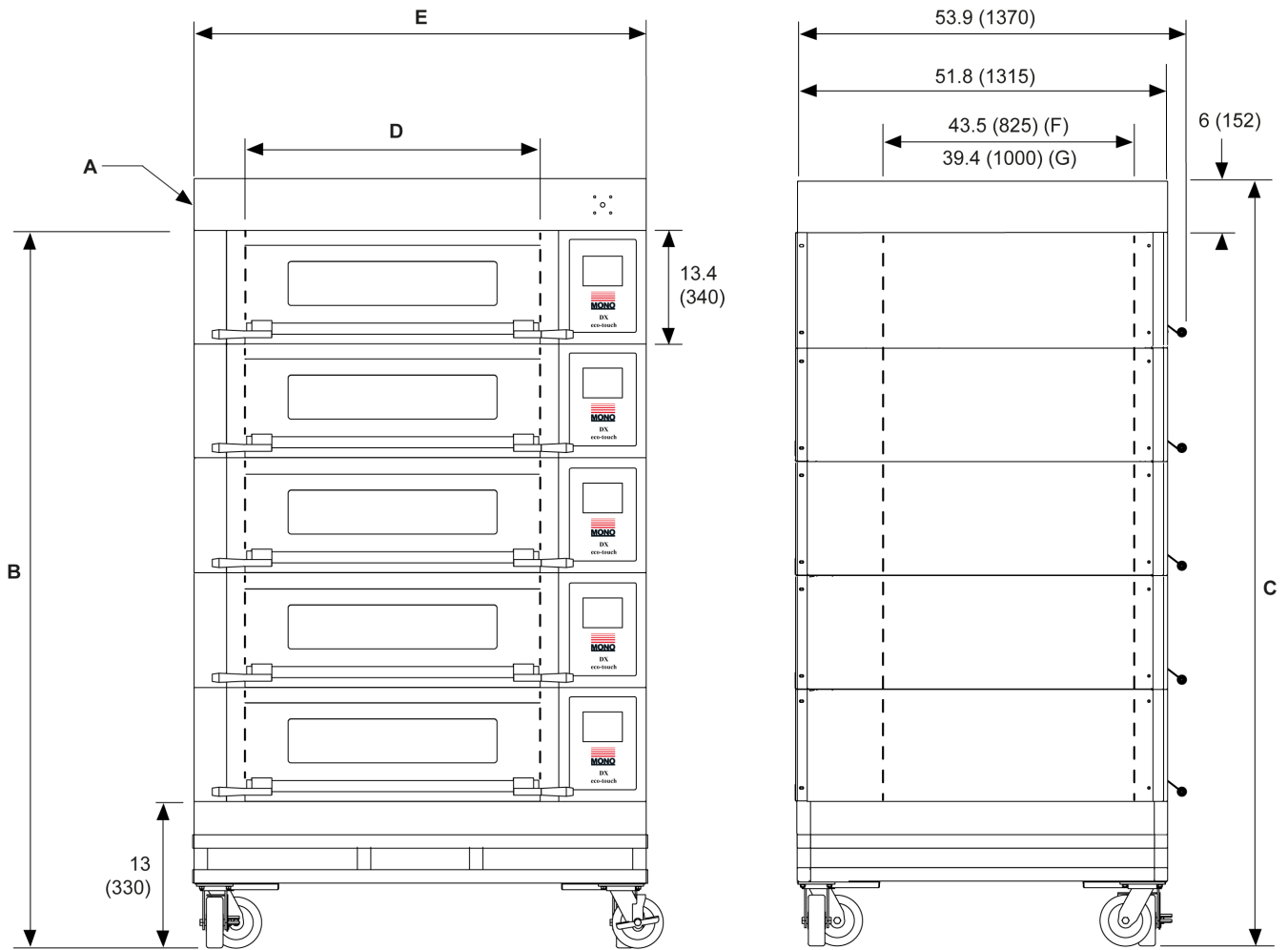

- A. Top valence or extractor hood (to customer specifications)
- B. 5-deck: 78.2 in. (1985 mm); 4-deck and 3-deck: 73.6 (1870 mm)
- C. 5-deck: 78.2 in. (2135 mm); 4-deck and 3-deck: 73.6 (2020 mm)
- D. Baking chamber width – see [Table 5](#) on page 17
- E. Overall deck width – See [Table 6](#) on page 17
- F. Baking tiles – See [Table 7](#) on page 17
- G. Chamber

Table 4: Internal usable surface areas and number of pans per deck

Nominal pans wide	Internal usable surface area (per deck)	Number of pans (per deck)	
	ft ²	18 in. x 30 in.	18 in. x 26 in.
3	12.5 ft ²	3	3
2	8.28 ft ²	2	2
1	4.2 ft ²	1	1

Table 5: Baking chamber widths

Number of pans	Chamber width	
	mm	inches
1	483	19
2	950	37
3	1420	56

Table 6: Overall deck widths

Number of pans	Deck width	
	mm	inches
1	955	37½
2	1416	55¾
3	1890	74½

Table 7: Baking tiles

Number of pans	Number of baking tiles (pieces)
1	1
2	1
3	1

**NOTE**

■ See pages **24** and **25** for canopy dimensions.

4. Safety

General safety messages

**CAUTION****■ Magnets information:**

- Magnetic fields in magnets, used in devices and machinery, can inhibit pulse generators for Implantable Cardioverter Defibrillators (ICDs) and pacemakers. Magnets can activate a switch prohibiting the ICD from delivering vital signals such as lifesaving shocks.
 - If you have an ICD or pacemaker, avoiding close or prolonged contact with magnets or their magnetic fields is advisable. Keep magnets at least six inches from where your device is implanted. **If you feel any interference in any way, immediately move away from the source.**
-

Oven safety messages

Only fully trained and authorized persons are permitted to work on the oven. Qualified electricians must carry out all repairs and maintenance. Always disconnect or isolate the power supply before starting maintenance or cleaning work on the oven.

A responsible Bakery Manager or Supervisor must carry out daily safety checks. Bakery staff **must not**, under any circumstances, remove covers or panels to access any part of the oven.

**DANGER**

- Never use the USB port to power or recharge electronic devices, e.g. mobile phones. Incorrect usage causes damage to the oven and could result in a fire.**
-

**WARNING****■ Before using the oven:**

- Ensure all covers, panels, cables, and pipe fittings are secure.
 - Visually examine the oven for apparent damage or signs of tampering.
 - If the oven is damaged or malfunctioning, or missing parts:**
 - Stop using it.
 - Do not attempt any repairs.
 - Contact MONO Equipment for technical assistance.
 - Never operate the oven with any covers or panels removed.**
 - All utility connections to the oven must comply with the statutory requirements of the country where the oven is installed.**
 - Ensure this product manual is read thoroughly before operating the oven. Operate and maintain the oven only as described in this product manual.**
-

**WARNING**

- An electrical socket must be protected by a 30mA-rated Type 'A' Residual Current Device (RCD) before installation and commissioning of the oven.
 - Always fit a wall-mountable isolator switch to isolate the oven entirely from the electrical supply in an emergency. The isolator must be visible, labelled as an emergency shutdown device, and easily accessible.
 - Check that the electrical requirements on the oven's information plate match the supply before connecting the power cable and turning the power on for the first time.
 - Before installation, it is recommended that a qualified and competent electrician first tests the electrical outlet for electrical safety.
 - Always ensure your hands are dry before touching any electrical components, including cables, switches, and plugs.
-

**CAUTION**

- Be aware of hot surfaces:
 - Do not touch the oven door with bare skin.
 - Always use oven gloves when loading or unloading the oven.
 - Allow time for the oven to cool down before cleaning it.
 - While the oven is in operation (and for some time after use), touching the oven door or the surrounding panels is inadvisable because of conducted heat.
 - When removing products from the oven, ensure the following:
 - Tins are knocked out and stored directly onto a tin storage trolley or rack. Do not leave hot tins on the floor or tables.
 - Trays are put into a rack and then wheeled to a safe cooling area.
 - Fully train operatives before they use the oven. Anyone undergoing training must be under the direct supervision of someone experienced.
 - Ensure there are no trip hazards around the oven, e.g. trailing cables.
 - Check that the floor around the oven is not slippery, e.g. no liquid spills.
 - Do not store items on top of or behind the oven.
 - Never climb onto the roof of the oven.
 - Only use the oven for baking bread, pastries, and cakes. Contact MONO Equipment for other product-baking machines.
 - No unauthorized modifications to the oven are permitted.
-

Emergency instructions

To stop the oven in an emergency, switch it off using the main isolator on the oven.

A wall-mounted isolator, rated for the specific model of oven installed, must be available to isolate the oven in an emergency completely. The isolator must be accessible and known to the oven operator.

Figure 1: Main isolator switch on the oven

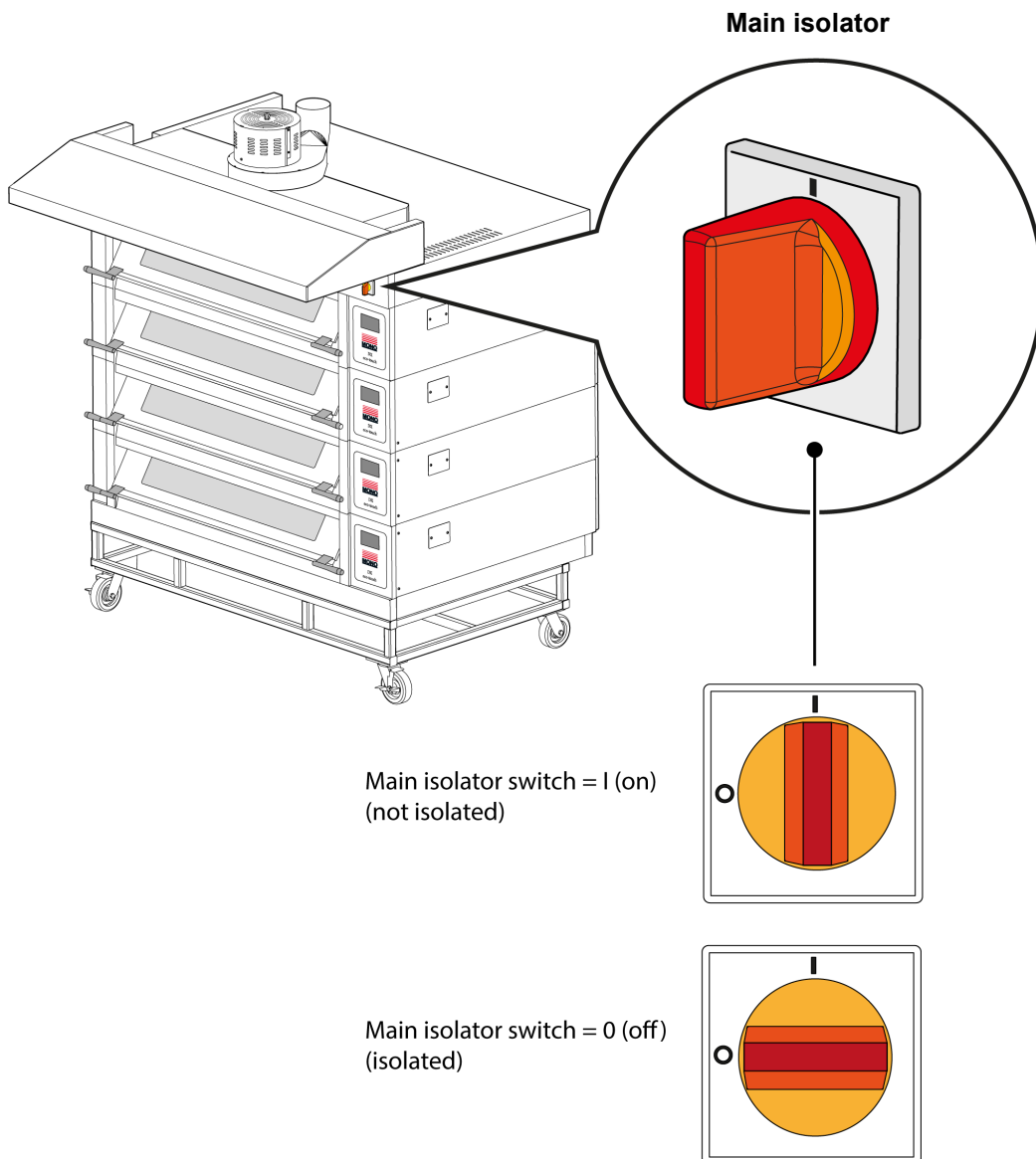

5. Installation

General

- A solid, smooth, level floor is recommended on which to position the oven, and access for maintenance should be considered.
The oven is not designed to be a “built-in” design. Sufficient clearance must be left in front of the access panels (right-hand side) for servicing.
- If not chosen as an oven option, an extraction hood should be sited above the oven to disperse excess steam and heat, which could adversely affect the bakery ceiling and ambient temperature.
- A chain retainer, shorter than the power cables, should be fitted to protect them from strain if the oven moves. Fit it to the wall or floor and the base, using the hole in the castor fixing corner plates.
- Only trained engineers are authorized to install this oven. All water and electrical connections must comply with local and national regulations.

Electrical connections

- The main connection point for all deck supplies is at the top of the oven.
- A wall isolator must be available to isolate the oven completely. This isolator must be easily accessible to the oven operator.
- Read the **Safety** section on **page 18**.
- Electrical loadings are in the **Specifications** section on **page 13**.

Fit earth straps (part no. 158-25-11200)



NOTE

- Factory-built ovens already have them fitted, but always check that they are fitted.

Figure 2: Connect earth (ground) straps between each modular deck

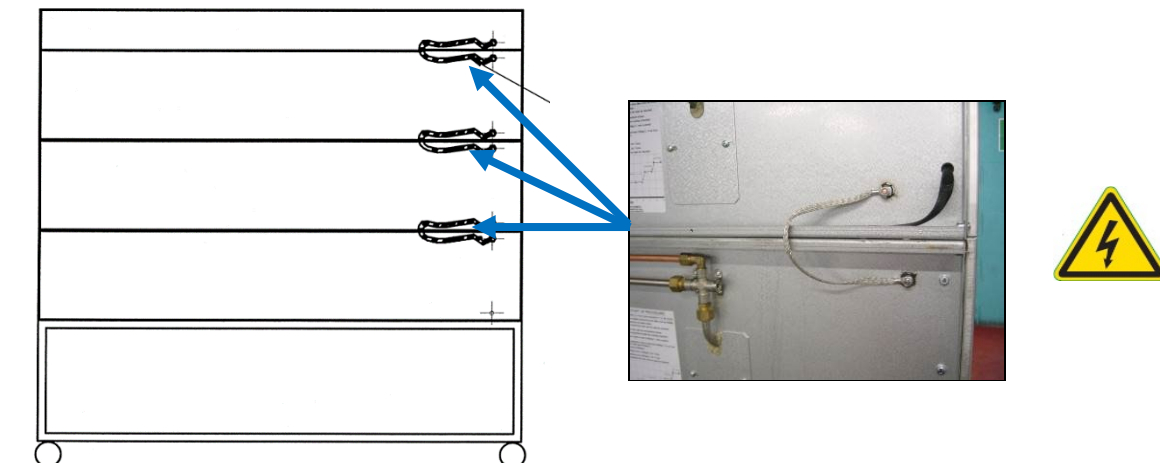

Fit the tile retaining brackets (part no. 257-06-00015)



NOTE

- Only deck ovens built on-site need this procedure, but always check that they are fitted.

Procedure

1. Find the brackets and screws loose in a supplied plastic bag.
2. Position the bracket to touch the tile (as shown in the photograph)
3. Fix the bracket using two screws.
4. Repeat steps 1 to 3 for both sides of each deck.

Figure 3: Installing the tile retaining brackets

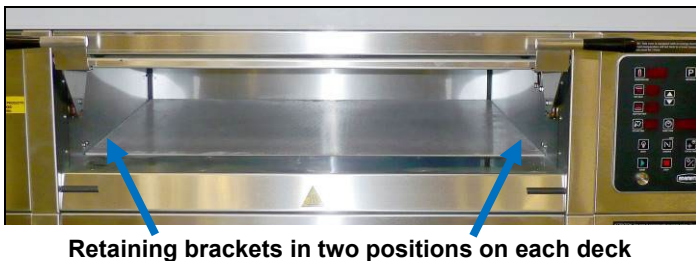

Water supply requirements



NOTE

- The setup procedure on the next page must be followed to allow the steaming system to function correctly.

- All ovens with steam require a 3/4" BSP hot or cold water supply at a pressure of 2 to 3 bar (29 to 44 psi).
- Only one water supply is required per oven and must comply with local water regulations.
- All decks are supplied from one connection point on the rear of the oven.
- For proper operation of the steam system, it is recommended that the water supply has the following specifications:

Hardness 0 to 4 grains per gallon

PH range 7.0 to 8.5

Chloride concentration 0 to 20 ppm

Consult Mono for proper water filtration system information.

- No drain is required for this oven.
- A non-return check valve is supplied and fitted to the water inlet manifold.

Water system setup procedure



The water delivery to the deck oven must be checked for the steam system to operate correctly.

Note that dynamic pressure, not static pressure, is being measured.

Procedure

1. Flush out the main feed pipe to be used until water runs clear and free from debris.
2. Connect the main feed to the oven.
3. Connect flexible hoses to each deck.
4. Place a container under the test valve (**B**).
5. Slowly open test valve (**B**) fully and, with the water flowing, set the regulator (**C**) to 0.75 bar using the screw underneath (**D**).
 - Never use the oven above this setting.
6. When the pressure has stabilized, shut the test valve (**B**).
7. Repeat steps 4 to 6 at the end of the installation.

Figure 4: Water regulator setup (located on the rear of the oven)

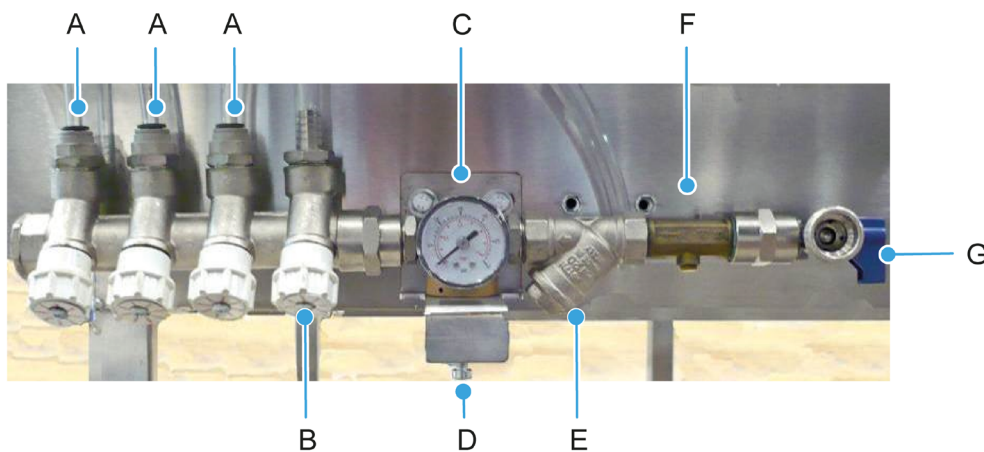

-
- A. To ovens
 - B. Test valve
 - C. Regulator
 - D. Adjusting screw to 0.75 bar
 - E. Filter
 - F. Dual check valve backflow prevention device
 - G. Stop tap
-

Exhaust Connections (if canopy fitted)

- Ideally, an exhaust duct should rise 2 metres above the bakery roof and be protected from wind and birds by a duct protector.
- It should be of a suitable material to take the high temperatures and humidity expected.
- It should be flexible and easily removable at the oven connection point.
This allows the oven to be moved for cleaning when required.

Figure 5: Canopy (without fan) dimensions

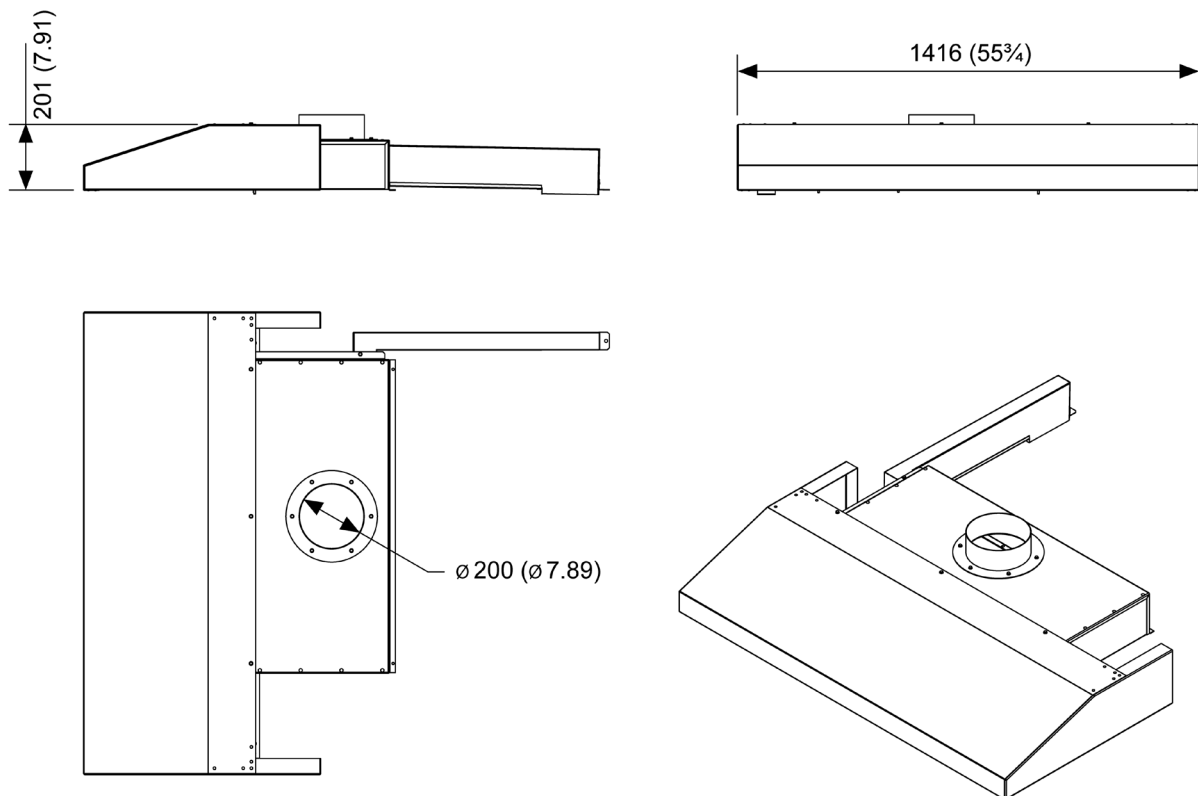

Dimensions are in mm (inches)

Figure 6: Canopy (with fan) dimensions

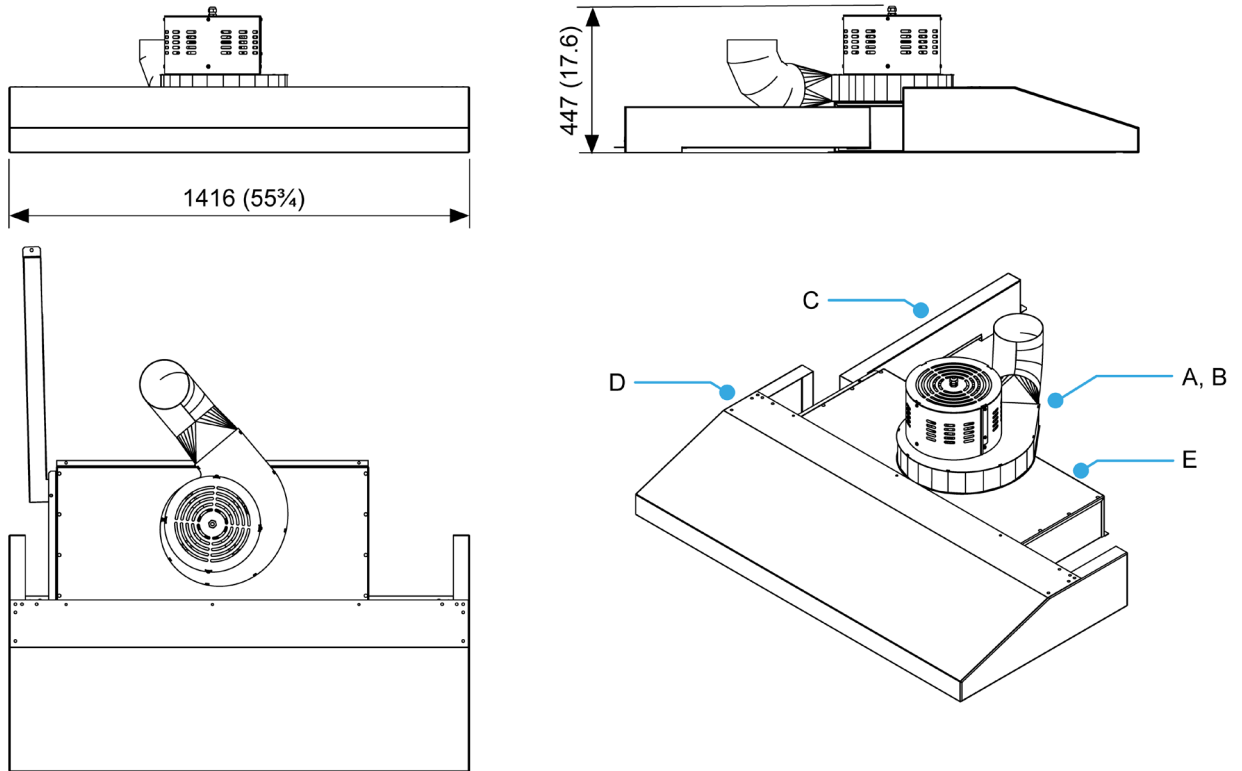

Dimensions are in mm (inches)

Table 8: Canopy parts

Item		Part number
A	Extraction fan assembly	247-08-04900
B	Inlet ring	247-08-05100
C	Flue assembly	257-10-00010
D	Canopy assembly	257-10-00016
E ⁽¹⁾	Extraction duct assembly for 2-pan oven width	257-10-00022

⁽¹⁾ Contact MONO Equipment for the availability of other extraction duct assemblies.

6. Before first use of the deck oven

Operating conditions

- Leave a clear space of at least 2 to 3 metres (6 to 10 ft.) in front of the oven for practical and safety reasons.
- Do not use bakery utensils to operate the control panel buttons.
- Ensure that the locking casters are locked into position.
- For hygiene reasons, MONO Equipment highly recommends thoroughly wiping the inside of the oven and all accessories with a clean cloth soaked in warm soapy water before using the oven for the first time. Although the utmost care is taken during assembly and pre-delivery inspection, there is always a possibility of residue contaminating the first bake if this is not done.

Baking tile ‘seasoning’ instructions

THIS PROCEDURE MUST BE FOLLOWED FOR THE OVEN'S WARRANTY TO REMAIN VALID.

For the oven to give good, reliable service, the deck tiles must initially be brought up to temperature as stated below; this ensures all residual moisture in the tiles has been removed.

This procedure must be actioned **once** before the deck oven is used for the first time. After the tile seasoning procedure has been run, the oven can be used as required.

Tile seasoning procedure

1. Press and hold the top and bottom heat buttons while powering on the deck oven.
2. Release the heat buttons after the controller beeps and the software version is displayed in the Bake Time window.

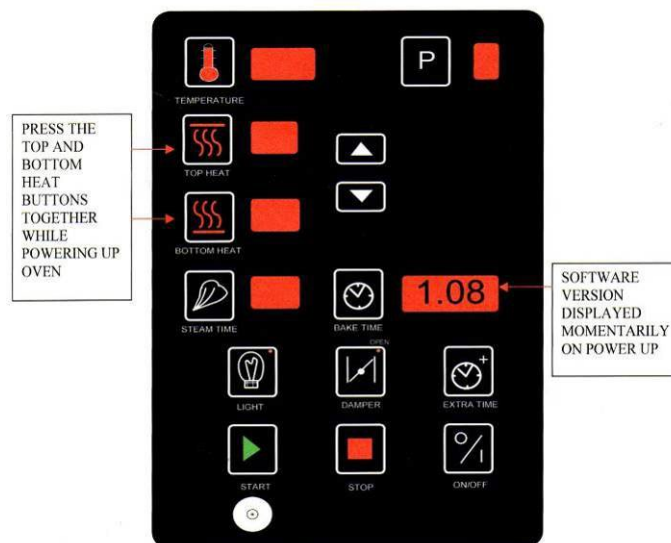

- 3. The oven’s controller now displays the **Target Temperature** and the **Remaining Process Time**.

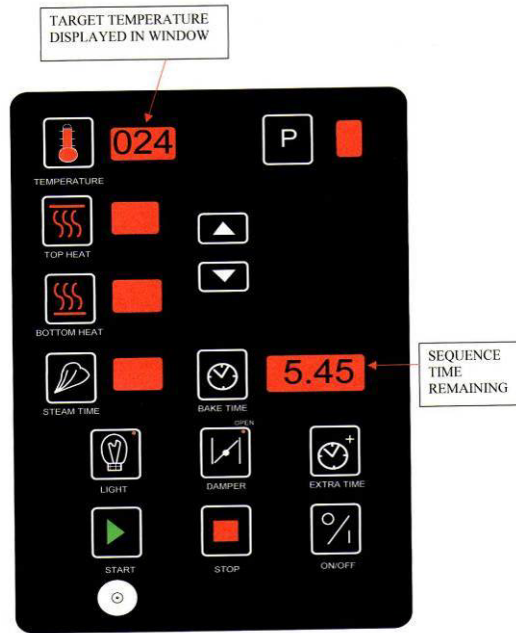

- 4. The Target Temperature increases by preset increments over 5 hours and 45 minutes. The Remaining Process Time counts down accordingly. During this process, the Damper opens every hour for 30 minutes to vent the moisture from the baking chamber.
- 5. At the end of the procedure, the oven switches into **Standby** mode and can be used for baking.



NOTE

- To stop the tile seasoning procedure, cycle the deck oven off and then on using the main isolator switch.
- The deck oven reverts to standby mode when power is restored.

Baking principles



NOTE

- Operators should refer to their company’s recipe manual for the oven temperature settings.

Baking heat

Products bake in an insulated, heated chamber with the temperature regulated by a thermocouple. A digital temperature read-out is visible on the control panel screen. Baking heat is radiant, with top and bottom heat adjustable by separate controls. This technology enables heat to be “balanced” according to product requirements.

Steaming function

Steam is provided from an integral steam unit and injected into the chamber on demand. Programmed parameters automatically control this function.

After being steamed, the oven does not allow more steaming until the steam unit has recovered heat, typically for 3 to 10 minutes, depending on the selected program.

All deck ovens have a steam damper that evacuates steam humidity into a vent at the rear of the oven.

Baking advice

Advice for getting the best results from deck ovens:

1. **Do not place the products too close together.** *If the loaves are close to each other after the oven spring (expansion), it results in soft sides and may collapse on cooling.*
2. **Place the product evenly within the oven.** *Products bunched together are paler than those widely spaced.*
3. **Products should not be too close to the edge of the tile.** *As it expands towards the front, one side of the loaf may enter the cooler air by the door.*
4. **The door opening should be kept to a minimum** *because cold air enters the oven. Cooling of the sidewalls and roof causes the finished product to be lighter locally at the front and wastes heat. If loading times are consistently long, alter the front-top heat to put more heat at the front.*
5. **The product can form a skin if the loading takes a long time,** *which causes an imbalance and a less attractive finish. By using the pre-steam function before loading, this can be minimized. The steam function turns the elements off and injects steam to increase the humidity.*

Bake settings

1. A good starting point for baking bread in Mono deck ovens is **225 °C** (437 °F).
Top heat: 60 to 65 **Bottom heat:** 40
2. For cookies (and similar products), the oven's heat can be turned almost off. However, it may still be necessary to place the trays with, e.g. cookies, onto upturned trays on the oven sole.
3. **Steam** should be kept to a minimum for energy efficiency, depending on the product and finish. **Times of between 9 and 12 seconds should be adequate.** It is a good idea not to focus on the temperature recovery – this can vary from oven to oven.

Is the product baked in the time and to the quality you require?

Below are some tips for modifying the bake to get the product that you require.

- If your product is **light on top**, decrease the bottom heat and extend bake time or increase the top heat.
- If the product **sides are pale** and the **top dark**, space the products well apart, drop the top heat, and extend the bake time.
- **If the bake time is too long**, first increase the top heat to speed recovery. If this does not give sufficient savings, increase the baking temperature.
- **To thicken the crust**, set the Damper to be open for longer. Different ovens require different lengths of time.

7. Operating Instructions

Each deck has an independent LED screen for operating the oven.

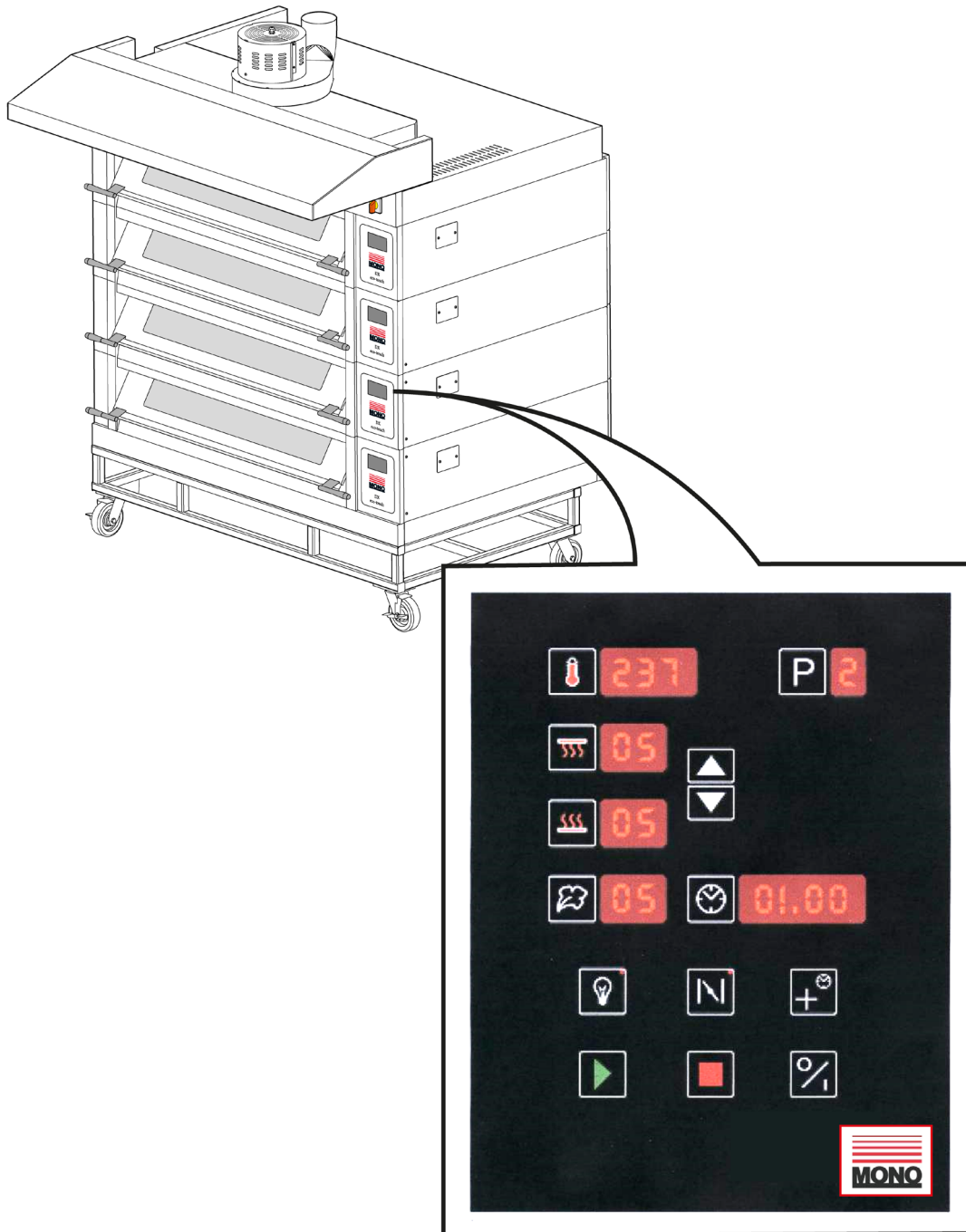

Basic operation

Perform operations by touching icons on the screen.

Figure 7: Classic LED screen icons

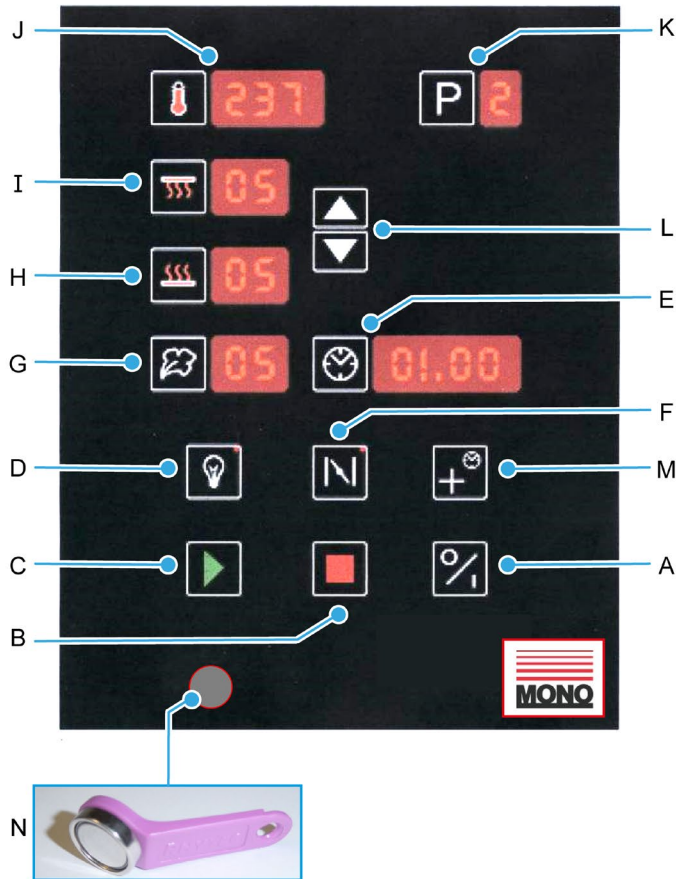

-
- | | | |
|-----------------------|---|---------------------------|
| A. ON/OFF | B. STOP | C. START |
| D. LIGHT | E. AUTO-ON SET / ADD TIME | F. DAMPER |
| G. STEAM TIME | H. BOTTOM HEAT | I. TOP HEAT |
| J. TEMPERATURE | K. PROGRAM | L. UP/DOWN BUTTONS |
| M. BAKE TIME | N. iButton connection (probe reader) | |
-

ON/OFF button (A)

This button turns the controller on from standby mode. Also, used to exit setup mode.

STOP button (B)

This button stops the bake cycle. Also, use with button **C** to navigate to a function setup menu on power-up (with button **C**).

START button (C)

This button starts a bake cycle. Use with button **B** to navigate to a setup menu on power-up. Also, it silences the “2 minutes from the end-of-bake” alarm when sounding.

LIGHT button (D)

Interior light on/off.

- A red light shows when the light is on.
- Press to turn on, and press again to turn off.

BAKE TIME/ADD TIME button (E)

This button accesses the set bake time and the current time and day setup. Also, for navigating the day/hours/minutes when setting time and setting auto on time.

If the 7-DAY TIMER is enabled:

- During a bake cycle, use this button to add extra bake time (+1 minute for each press).
- At the end of a bake, press for two minutes and then once for each extra minute required.

DAMPER button (F)

Press to open the Damper, and press again to close the Damper. (It only works during a bake). Closes when stop pressed at the end of bake and while steaming. A red light shows when in the open position.

STEAM TIME button (G)

Press to access steam time and pre-steam mode.

If the pre-steam function is enabled:

- Press once (red dots appear). Use the **UP/DOWN** buttons (L) to change to the required setting. **P0** = no pre-steam, **P1** = 1 second, and **P2** = 2 seconds.
- Press again to set the steam time using the **UP/DOWN** buttons (L).
- Press the button again to save or wait 10 seconds to auto-save.

If the pre-steam function is not enabled:

- Press to set the steam time using the **UP/DOWN** buttons (L).
- Press the button again to save or wait 10 seconds to auto-save.

BOTTOM HEAT (H)

Press to set the bottom heat cycle percentage. Use the UP/DOWN buttons (L) to adjust the value. Press the button again to save or wait 10 seconds to auto-save.

TOP HEAT (I)

Press to set the top heat cycle percentage. Use the UP/DOWN buttons (L) to adjust the value. Press the button again to save or wait 10 seconds to auto-save.

TEMPERATURE (J)

Press to set the baking temperature required. Use the UP/DOWN buttons (L) to adjust the value. Press the button again to save or wait 10 seconds to auto-save.

PROGRAM (K)

Use the UP/DOWN buttons (L) for cycling to the required program.

To save the current settings, press and hold the P button for 5 seconds. All the displays will flash, and a beep confirms the saved settings.

UP/DOWN BUTTONS (L)

Press to adjust values when required.

AUTO ON SET / ADD TIME (M)

If the 7-DAY TIMER is enabled:

- Use the button to access auto-switch-on times.

If the 7-DAY TIMER is disabled:

- During a bake cycle, use this button to add extra bake time (+1 minute for each press).
- At the end of a bake, press for two minutes and then once for each extra minute required.

iBUTTON CONNECTION (N)

MONO engineers use this button and a unique “iButton” storage device to change the firmware of the oven. See the next page for details.

Firmware update using the iButton

Firmware update procedure

1. Place the deck into the standby state (clock displaying).
2. Place iButton onto the probe ([Figure 7 | N](#)).

The controller will now upload data from iButton. During this process, a bake temperature window displays a countdown (going from 128 to 0) as data is uploaded.

The top heat window displays the number of failed reads from the iButton. If this count reaches 08, the upload will terminate (see Error conditions below).

After the data has been uploaded and checked, the controller enters a programming state. The bake temperature window now displays **Prg**. This process should take approximately 8 seconds to complete.



NOTE

- During this programming phase, do not disconnect the power to the oven or remove the iButton from the reader probe. If the power is interrupted, the re-programming of the Flash memory will be incomplete, and the controller will cease to function. The only way to recover from this is to re-program the unit via a pc with a programming cable.
-

When the programming update is complete, the controller resets and displays the new firmware version in the time window. The display shows the firmware version continually until disconnecting the iButton from the oven. After disconnection, the controller displays the clock and functions as usual.

Error conditions

If an upload fails, the bake temperature window displays errors as codes. No changes to the oven are applied when there is an upload error. Firmware is only updated if the upload from the iButton has been successful.

If an error is displayed, the oven waits for disconnection of the iButton before resetting and functioning as usual. An upload (firmware update) can then be re-attempted.

If the iButton is disconnected whilst uploading is in progress, the upload terminates and the oven resets.

E01

If the controller fails to read the iButton successfully eight times (in succession), **E01** appears in the bake temperature window. This error may be due to poor contact between the probe and the iButton, or bad data on the iButton. Try cleaning the surface of the probe – any small debris can affect the connection.

E02

This error appears if the file information on the iButton is incorrect or the iButton is blank (unprogrammed).

E03

This error appears if the iButton file CRC (cyclical redundancy check) does not match that calculated by the controller after a download, i.e. a corrupted iButton file.

Operating the oven

1. With the oven in standby mode (power on), press the **ON** button (**Figure 8 | A**).

2. Press **P** (program) button (**Figure 8 | K**).

3. Using the **UP/DOWN** buttons (**Figure 8 | L**), choose the set program required.

The oven now heats to the temperature required. It is ready for use when the display shows the temperature of the program chosen and, if steam is needed, the display stops flashing.

4. Load the oven as required.

To preserve heat, do not leave doors open more than needed to load the oven.

5. Press the **START** button (**Figure 8 | C**).

Press the **BAKE TIME** button (**Figure 8 | M**) at any time during the baking to add 1 minute to the bake time.

If required during the bake, press the **DAMPER** button (**Figure 8 | F**) once to open the Damper, and press it again to close. A red light shows when the Damper is in the open position. If left open for 90 minutes, it closes automatically).

6. If enabled in the oven setup, a buzzer sounds for 10 seconds when the baking is 2 minutes from completion.

Press the **START** button to silence the buzzer.

7. At the end of the bake, the buzzer will sound.

Press the **STOP** button (**Figure 8 | B**) to silence the buzzer.

8. **If requiring extra baking at the end of a bake:**

(a) Press the **BAKE TIME** button to set 2 minutes and 1 minute for each additional press.

(b) After selecting the extra time, press the **START** button or wait 5 seconds for the bake countdown will start automatically.

**NOTE**

■ Steam is not available when using this extra time baking.

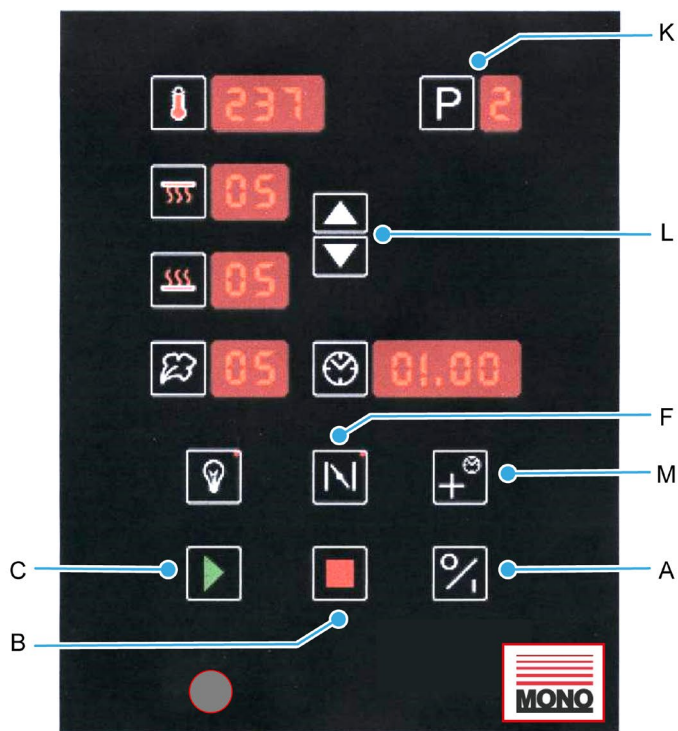
Figure 8: Operating the oven – Classic LED screen icons

Setting the day and time

1. Turn the power supply on.
This will put the oven in “standby mode” with only the clock showing.
2. Press the **CLOCK** button (**Figure 9 | E**) and dots will flash under the hours in the time window.
Change the hours using the **UP/DOWN** buttons (**Figure 9 | L**).
3. Press the **CLOCK** button again and dots will flash under the minutes in the time window.
Change the minutes using the **UP/DOWN** buttons (**Figure 9 | L**).
4. Press the **CLOCK** button again and the day number will show.
Change the minutes using the **UP/DOWN** buttons (**Figure 9 | L**). Usually, day 1 is used as Monday.
5. Press the **CLOCK** button within 5 seconds to save the settings.

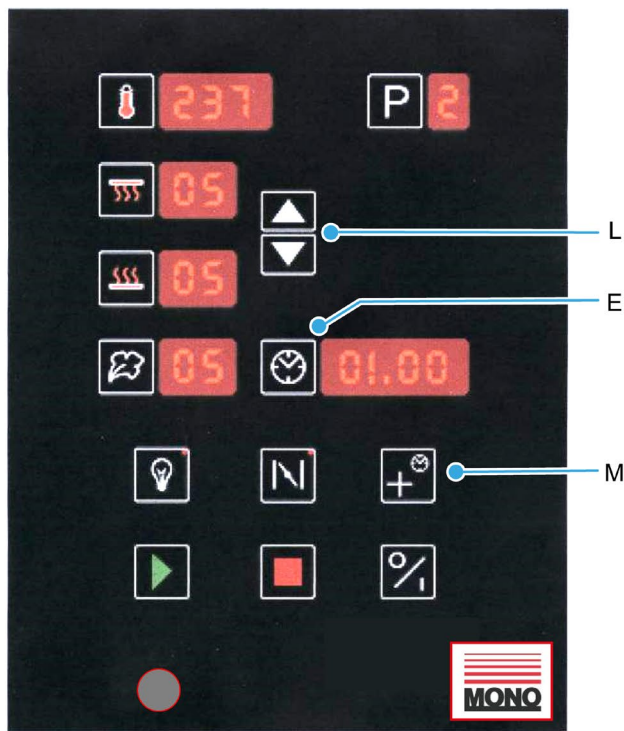
Figure 9: Setting the day and time – Classic LED screen icons

Setting the 7-day timer



NOTE

■ Enable F15 in the setup for the 7-day timer to function.

Procedure for setting a timer event

1. Press the **I/O** button to put the controller into standby mode.
Only the current time displayed in the bake time window.
2. Press the **BAKE TIME** button (**Figure 9 | M**).
The day of the week appears in the P window (and dots appear next to the day).
Press the **UP/DOWN** button (**Figure 9 | L**) to change the day number.
3. Press the **CLOCK** button (**Figure 9 | E**) and dots appear under the hours in the time window.
Change the hours using the **UP/DOWN** buttons (**Figure 7 | L**).
4. Press the **CLOCK** button (**Figure 9 | E**) again and dots appear under the minutes in the time window.
Change the minutes using the **UP/DOWN** buttons (**Figure 9 | L**).
5. Press the **BAKE TIME** button (**Figure 9 | M**) to save and exit the timer setup.

**NOTE**

- If you do not alter the hours and minutes within 6 seconds, the timer setup defaults back to day setting. Dots appear next to the P window. Just press the BAKE TIME button to return to the time setup again. Setting a time of 00.00 in the timer setup is a non-event so will not switch on the controller.

Setup mode

1. To enter setup mode, press and hold the **START** button (Figure 10 | A) and **STOP** button (Figure 10 | B) at the same as turning on the power supply.
2. Change the function in the temperature window (Figure 10 | C) using the **UP/DOWN** buttons (Figure 10 | D). See the next page for a function list.
3. Press the **CLOCK** button (Figure 10 | E) – dots appear on the display.
4. Change the setting for the function using the **UP/DOWN** buttons (Figure 10 | D).
5. Press the **CLOCK** button (Figure 10 | E) to save the setting for that function.
6. Repeat steps 2 to 5 for each function to be changed.
7. Press the **ON/OFF** button (Figure 10 | F) to exit setup mode.

**NOTE**

- Any changes to the functions are only saved when exiting using **ON/OFF** button.

Figure 10: Setup mode – Classic LED screen icons

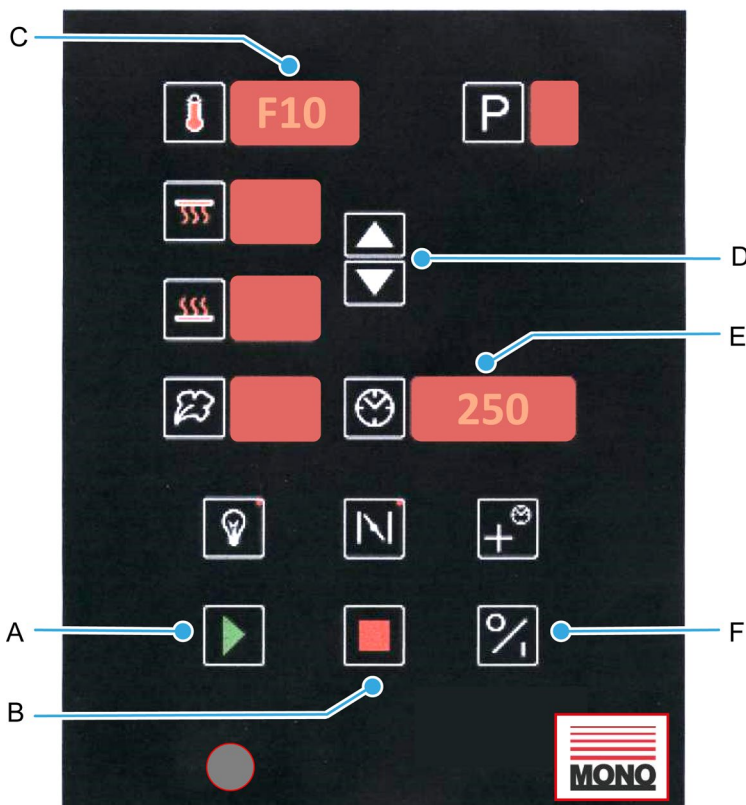

Table 9: Parameter function list

ID	Function description	Default setting
F1	MONO constant (factory set)	250
F2	Top heat gain	50
F3	Bottom heat gain	50
F4	Front-top element offset	25
F5	Deg "C", Deg "F" (0=C, 1=F)	0
F6	2 minute from end-of-bake alarm (Enable=1, Disable=0)	0
F7	Pre-steam (Enable=1, Disable=0)	0
F8	Steam (Enable=1, Disable=0)	1
F9	Bake temperature offset (+/- 25 Deg C)	0
F10	Set temperature limit (Deg C) – maximum is 290 Deg C.	250
F11 ⁽¹⁾	Bake controls lockout (Enable=1, Disable=0)	0
F12	Sleep mode delay time (60 minutes maximum; Disable=0)	0
F13	Interior light auto-timeout – ON/OFF (1 to 20 minutes; Disable=0)	1
F14	0-9 Program	9
F15 ⁽²⁾	7-day time (Enable=1, Disable=0)	1
F16 ⁽³⁾	8 hour countdown timer (Enable=1, Disable=0)	0
F17	Lamp output soft start (Enable=1, Disable=0)	0

⁽¹⁾ To prevent an operator from changing the set bake parameters.

⁽²⁾ If enabled, the "SET BAKE" time acts as an extra time button. If disabled, "AUTO ON SET" acts as an extra time button.

⁽³⁾ After 8 hours, the oven turns itself off (not during a bake cycle). Before going off, displays flash and an alarm sound. At this point, pressing any button adds an extra hour to the time.

**NOTE**

■ After switching on the controller, before the sleep delay time is initiated (if enabled in F12), the set bake temperature must be reached, steam recovery time elapsed, and a bake cycle started and stopped. After the STOP button has been pressed at the end of a bake, the sleep delay timer counts down until it reaches 0. At this point, the controller switches into sleep mode (SLP displayed in temperature window) and the oven will drop to a pre-set fall-back temperature of 170°C (338°F), which it will maintain. Be aware that the damper closes when oven goes into sleep mode.

Pressing any button during the sleep mode delay time will not affect the countdown, apart from the ON/OFF button which switches the controller off. Pressing the START or STOP buttons resets the countdown timer.

Pressing any button while in sleep mode (except the LIGHT button – which operates as normal – and the panel ON/OFF) brings the controller out of sleep mode. The oven then heats up to its previous set bake temperature. A typical recovery time from 170°C to 230°C (338°F to 446°F) is approximately 15 minutes.

Be aware that if no buttons on the controller are pressed after exiting sleep mode, the controller returns to sleep mode after the sleep delay time has expired.

Figure 11: Controller layout

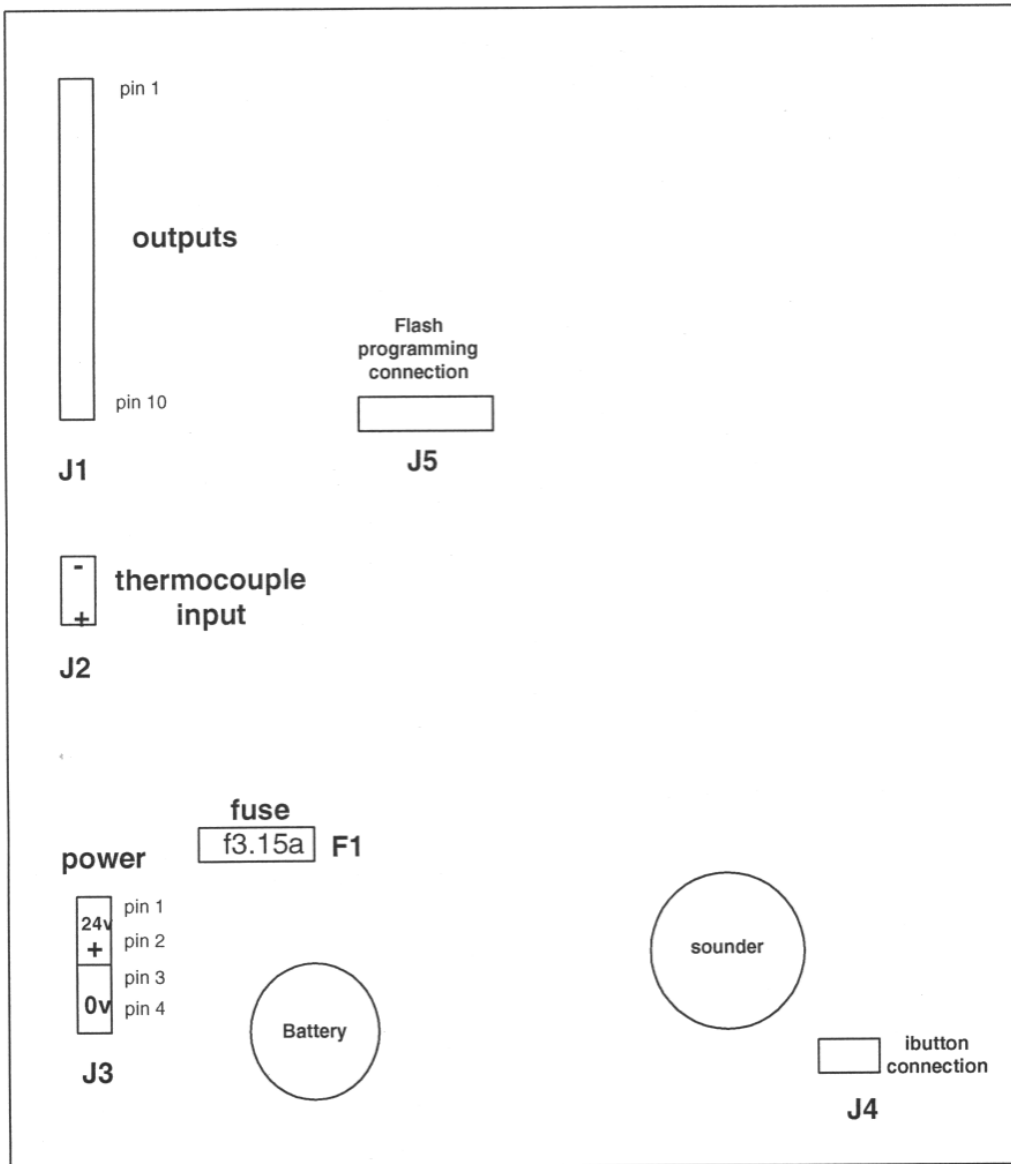

OUTPUTS

- PIN 1 – 24v
- PIN 2 – TOP HEAT OUTPUT
- PIN 3 – TOP FRONT HEAT OUTPUT
- PIN 4 – BOTTOM HEAT OUTPUT
- PIN 5 – STEAM OUTPUT
- PIN 6 – DAMPER OUTPUT
- PIN 7 – LIGHT OUTPUT
- PIN 8 – CANOPY FAN RELAY OUTPUT
- PIN 9 – 24v
- PIN 10 – 24v

8. Cleaning

Daily cleaning instructions



Isolate the oven from the electrical supply before cleaning.



Take care that water does not enter the control-panel mounting or roof-mounting fan.
Never use a pressure washer or water hose to clean the oven.

Procedure

1. Sweep any debris out of the oven **after** it has been allowed to cool.
NOTE: Use a vacuum cleaner with metal attachments (i.e. able to take the heat), if available.
2. Brush down and wipe the oven front, back and sides with a damp cloth.
3. Spot clean outside with a damp cloth, soaked in a solution of mild detergent and hot water.
Ensure excess water is not applied around the electrical panels.

Weekly cleaning instructions



Isolate the oven from the electrical supply before cleaning.



Take care that water does not enter the control-panel mounting or roof-mounting fan.
Never use a pressure washer or water hose to clean the oven.



Do not stand on the roof.

Procedure

1. Complete the daily cleaning procedure, as above.
2. Use a nylon brush to scrub the wheels with a mild detergent and hot water.
NOTE: Using too much water eventually rusts the metalwork.
3. Ensure the oven roof area is clear of debris and dust build-up.

9. Troubleshooting

None of the decks switched on

- Is the oven's main isolator set to the on (I) position?
- Check if a time clock of the bakery's mains power supply is working (if fitted).
- Is the clock set correctly to power the oven at the required day and time?

One deck has not switched on

- Check if the individual deck timer is to come on at a specific time.

Uneven or patchy bake

- The deck door is open too often or too long whilst loading (front pale, back burnt).
- Uneven loading.
- Faulty element.
- Top or bottom deck elements are not functioning.
- No supply voltage across a phase.

Actual temperature is far exceeding the set temperature

When empty, the temperature of a deck oven can exceed the set baking temperature. This overheat is marginal when the deck is full of product. If the elements are continuing to work after the set temperature has been reached, call MONO service.

(Please allow up to 15 °C (59 °F) difference before diagnosing a fault condition).

Poor recovery of actual temperature after loading

- Doors may have been left open too long during loading, allowing heat to escape.
- Damper may have been left open during loading/baking, allowing heat to escape.
- Top or bottom heat may not be working.
- No supply voltage across a phase.

Steam system not operating correctly





- Is water connected correctly?
- Is the tap to each deck in the on position?
- Has enough time elapsed since the last steaming?

Once steamed, the oven does not steam until the steam unit has recovered heat, typically 3 to 10 minutes depending on the program selected.

10. Service

Oven spares

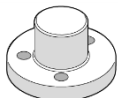
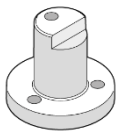
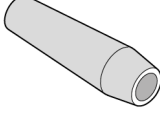
Table 10: Oven spares

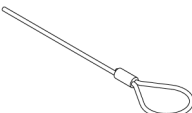
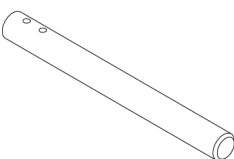
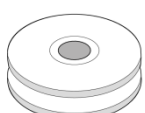
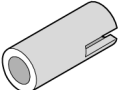
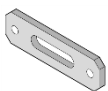
Spare		Part number
Frosted glass (lights)		257-02-00027
Plain glass (lights)		257-02-00028
Door bumper stop		257-03-00094
Hinge pin, right-hand-side		257-03-00005
Hinge pin, left-hand-side		257-03-00009
Black door handle		A900-27-192
Door spring		257-03-00017
Wire rope		257-03-00024
Spring retaining pin		257-03-00025
Pulley		257-03-00015
Pulley spindle		257-03-00013
Damper drive coupling		257-07-00007
Element gasket		245-02-01300

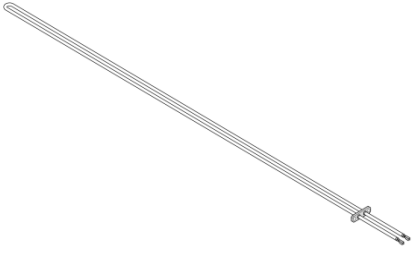
Spare		Part number
24v 20w Dichroic Lamp		B855-94-008
Top and bottom heat elements		See Chapter 14

Service Information

If a fault arises, please do not hesitate to contact the MONO Customer Service Department. Quote the machine serial number on the silver information plate of the machine and on the front cover of this manual.



MONO Equipment

Queensway, Swansea West Industrial Park, Swansea, SA5 4EB UK

+44/0 1792 561234

Spares +44/0 1792 564039

Email: mono@monoequip.com

www.monoequip.com

Disposal

When the oven comes to the end of its working life, dispose of parts in the appropriate place by recycling or other means as the law permits at that time.

11. Maintenance

General maintenance



WARNING

- This appliance must be maintained at regular intervals. The frequency of maintenance will depend upon your specific use and location. The maximum service interval should be 12 months.
 - Service and maintenance should only be undertaken by suitably qualified, trained, and competent engineers.
 - You must immediately report any damage or defect arising with the appliance.
 - Unsafe equipment is dangerous. Do not use the appliance. Isolate the power supply and contact MONO or your appointed service agent.
-
- Check for frayed or bare cables.
 - **Do not** use the machine if frayed or bare cables are visible.
 - Follow cleaning instructions (see **Cleaning** on page 41).

Light bulb replacement



WARNING

- Disconnect from the supply before replacing light bulbs.

How to replace the 24Vac 20w lamp (part number B855-94-008)

1. Unscrew the plate (**A**) next to the light to be replaced.
 - Keep the hex head socket screws (**B**) safe.

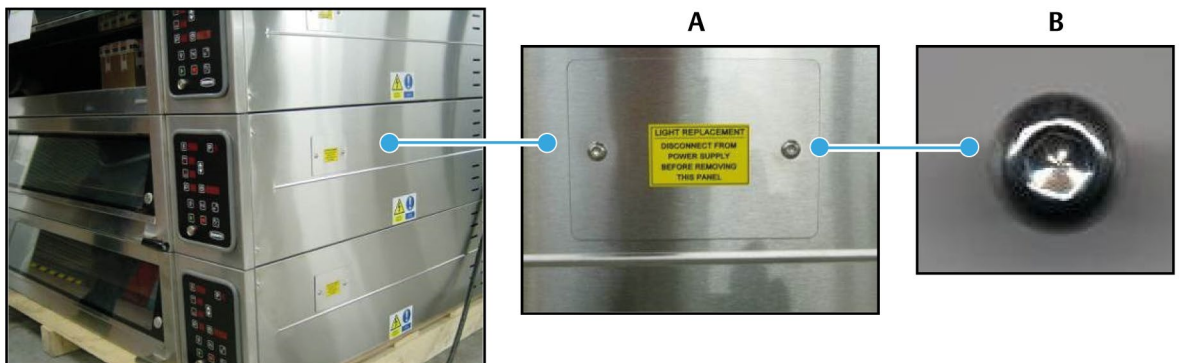

2. Slide the fitting out.

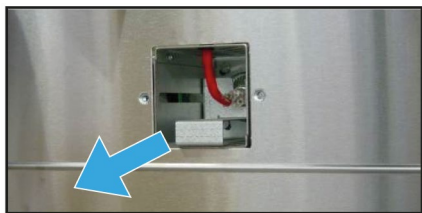

3. Remove the light from the holding slot and unclip from the cable.



4. Replace the light and refit all parts.



5. Reconnect the power supply and test.

12. Oven Electrics

Table 11: Parts list for the electrical drawings (3-pan wide)

Reference in drawing	Description	Part number
F1, F2, and F3	Heaters MCB (220 Vac)	B872-22-115
	Heaters MCB (480 Vac)	B872-22-113
F4	Control power supply MCB	B872-22-118
F5	Overheat thermostat	B888-30-015
T1	Control circuit power supply (220 Vac)	B801-93-005
	Control circuit power supply (480 Vac)	B801-93-009
K1	Top heat contactor	B801-08-021
K2	Bottom heat contactor	B801-08-021
Y1	Water solenoid (8 mm pipe)	A900-34-365
H1	Interior light	B855-94-008
B1	Oven thermocouple	B873-95-003
U1	Main LED printed circuit board	257-25-00071
D1	Damper solenoid	B749-83-004
R1	Top heat element, 1.0 Kw (220 Vac)	B854-04-089
	Top heat element, 1.0 Kw (480 Vac)	B854-04-096
R2	Top heat element, 1.0 Kw (220 Vac)	B854-04-088
	Top heat element, 1.0 Kw (480 Vac)	B854-04-094
R3	Top heat element, 0.6 kW (220 Vac)	B854-04-088
	Top heat element, 0.6 kW (480 Vac)	B854-04-094
R4	Top heat element, 0.6 kW (220 Vac)	B854-04-088
	Top heat element, 0.6 kW (480 Vac)	B854-04-094
R5	Top heat element, 0.6 kW (220 Vac)	B854-04-088
	Top heat element, 0.6 kW (480 Vac)	B854-04-094
R6	Top heat element, 0.6 kW (220 Vac)	B854-04-088
	Top heat element, 0.6 kW (480 Vac)	B854-04-094
R7	Top heat element, 0.6 kW (220 Vac)	B854-04-088
	Top heat element, 0.6 kW (480 Vac)	B854-04-094

R8	Bottom heat element, 0.75 kW (220 Vac)	B854-04-089
	Bottom heat element, 0.75 kW (480 Vac)	B854-04-095
R9	Bottom heat element, 0.6 kW (220 Vac)	B854-04-088
	Bottom heat element, 0.6 kW (480 Vac)	B854-04-094
R10	Bottom heat element, 0.6 kW (220 Vac)	B854-04-088
	Bottom heat element, 0.6 kW (480 Vac)	B854-04-094
R11	Bottom heat element, 0.6 kW (220 Vac)	B854-04-088
	Bottom heat element, 0.6 kW (480 Vac)	B854-04-094
R12	Bottom heat element, 0.6 kW (220 Vac)	B854-04-088
	Bottom heat element, 0.6 kW (480 Vac)	B854-04-094
R13	Bottom heat element, 0.6 kW (220 Vac)	B854-04-088
	Bottom heat element, 0.6 kW (480 Vac)	B854-04-094
R14	Bottom heat element, 0.6 kW (220 Vac)	B854-04-088
	Bottom heat element, 0.6 kW (480 Vac)	B854-04-094

Table 12: Parts list for the electrical drawings (2-pan wide)

Reference in drawing	Description	Part number
F1, F2, and F3	Heaters MCB (220 Vac)	B872-22-114
	Heaters MCB (480 Vac)	B872-22-112
F4	Control power supply MCB	B872-22-118
F5	Overheat thermostat	B888-30-015
T1	Control circuit power supply (220 Vac)	B801-93-005
	Control circuit power supply (480 Vac)	B801-93-009
K1	Top heat contactor	B801-08-021
K2	Bottom heat contactor	B801-08-021
Y1	Water solenoid (8 mm pipe)	A900-34-365
H1	Interior light	B855-94-008
B1	Oven thermocouple	B873-95-003
U1	Main LED printed circuit board	257-25-00071
D1	Damper solenoid	B749-83-004
R1	Top heat element, 0.65 kW (220 Vac)	B854-04-099
	Top heat element, 0.65 kW (480 Vac)	B854-04-105
R2	Top heat element, 0.4 kW (220 Vac)	B854-04-097
	Top heat element, 0.4 kW (480 Vac)	B854-04-103
R3	Top heat element, 0.4 kW (220 Vac)	B854-04-097
	Top heat element, 0.4 kW (480 Vac)	B854-04-103
R4	Top heat element, 0.4 kW (220 Vac)	B854-04-097
	Top heat element, 0.4 kW (480 Vac)	B854-04-103
R5	Top heat element, 0.4 kW (220 Vac)	B854-04-097
	Top heat element, 0.4 kW (480 Vac)	B854-04-103
R6	Top heat element, 0.4 kW (220 Vac)	B854-04-097
	Top heat element, 0.4 kW (480 Vac)	B854-04-103
R7	Top heat element, 0.4 kW (220 Vac)	B854-04-097
	Top heat element, 0.4 kW (480 Vac)	B854-04-103
R8	Bottom heat element, 0.5 kW (220 Vac)	B854-04-098
	Bottom heat element, 0.5 kW (480 Vac)	B854-04-104

R9	Bottom heat element, 0.4 kW (220 Vac)	B854-04-097
	Bottom heat element, 0.4 kW (480 Vac)	B854-04-103
R10	Bottom heat element, 0.4 kW (220 Vac)	B854-04-097
	Bottom heat element, 0.4 kW (480 Vac)	B854-04-103
R11	Bottom heat element, 0.4 kW (220 Vac)	B854-04-097
	Bottom heat element, 0.4 kW (480 Vac)	B854-04-103
R12	Bottom heat element, 0.4 kW (220 Vac)	B854-04-097
	Bottom heat element, 0.4 kW (480 Vac)	B854-04-103
R13	Bottom heat element, 0.4 kW (220 Vac)	B854-04-097
	Bottom heat element, 0.4 kW (480 Vac)	B854-04-103
R14	Bottom heat element, 0.4 kW (220 Vac)	B854-04-097
	Bottom heat element, 0.4 kW (480 Vac)	B854-04-103

Table 13: Parts list for the electrical drawings (1-pan wide)

Reference in drawing	Description	Part number
F1, F2, and F3	Heaters MCB (220 Vac)	B872-22-112
	Heaters MCB (480 Vac)	B872-22-111
F4	Control power supply MCB	B872-22-118
F5	Overheat thermostat	B888-30-015
T1	Control circuit power supply (220 Vac)	B801-93-005
	Control circuit power supply (480 Vac)	B801-93-000
K1	Top heat contactor	B801-08-021
K2	Bottom heat contactor	B801-08-021
Y1	Water solenoid (8 mm pipe)	A900-34-365
H1	Interior light	B855-94-008
B1	Oven thermocouple	B873-95-003
U1	Main LED printed circuit board	257-25-00071
D1	Damper solenoid	B749-83-004
R1	Top heat element, 0.325 kW (220 Vac)	B854-04-108
	Top heat element, 0.525 kW (480 Vac)	B854-04-114
R2	Top heat element, 0.2 kW (220 Vac)	B854-04-106
	Top heat element, 0.325 kW (480 Vac)	B854-04-112
R3	Top heat element, 0.2 kW (220 Vac)	B854-04-106
	Top heat element, 0.325 kW (480 Vac)	B854-04-112
R4	Top heat element, 0.2 kW (220 Vac)	B854-04-106
	Top heat element, 0.325 kW (480 Vac)	B854-04-112
R5	Top heat element, 0.2 kW (220 Vac)	B854-04-106
	Top heat element, 0.325 kW (480 Vac)	B854-04-112
R6	Top heat element, 0.2 kW (220 Vac)	B854-04-106
	Top heat element, 0.325 kW (480 Vac)	B854-04-112
R7	Top heat element, 0.2 kW (220 Vac)	B854-04-106
	Top heat element, 0.325 kW (480 Vac)	B854-04-112
R8	Bottom heat element, 0.25 kW (220 Vac)	B854-04-098
	Bottom heat element, 0.4 kW (480 Vac)	B854-04-113

R9	Bottom heat element, 0.2 kW (220 Vac)	B854-04-097
	Bottom heat element, 0.325 kW (480 Vac)	B854-04-112
R10	Bottom heat element, 0.2 kW (220 Vac)	B854-04-097
	Bottom heat element, 0.325 kW (480 Vac)	B854-04-112
R11	Bottom heat element, 0.2 kW (220 Vac)	B854-04-097
	Bottom heat element, 0.325 kW (480 Vac)	B854-04-112
R12	Bottom heat element, 0.2 kW (220 Vac)	B854-04-097
	Bottom heat element, 0.325 kW (480 Vac)	B854-04-112
R13	Bottom heat element, 0.2 kW (220 Vac)	B854-04-097
	Bottom heat element, 0.325 kW (480 Vac)	B854-04-112
R14	Bottom heat element, 0.2 kW (220 Vac)	B854-04-097
	Bottom heat element, 0.325 kW (480 Vac)	B854-04-112

Electrical drawings

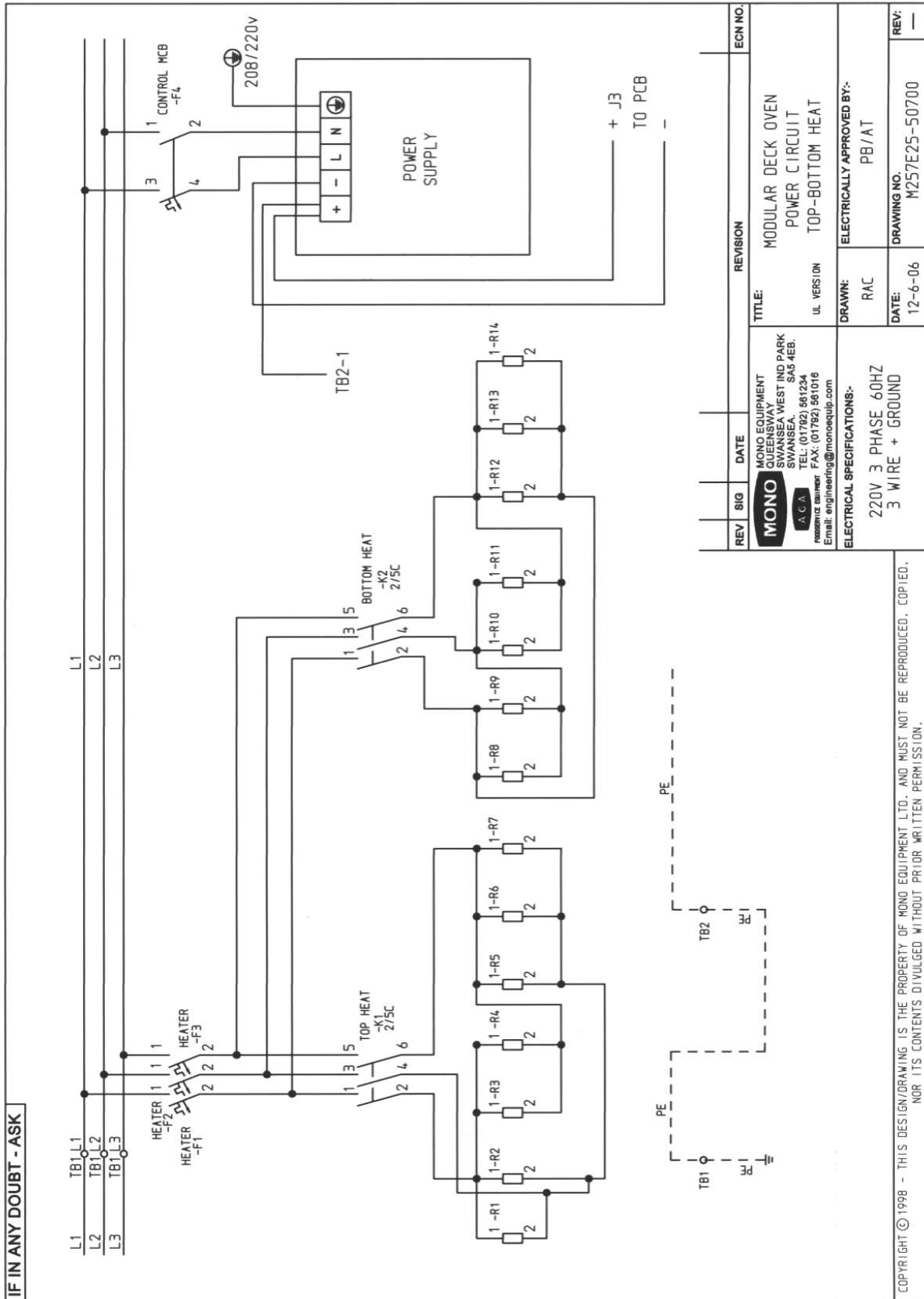

IF IN ANY DOUBT - ASK

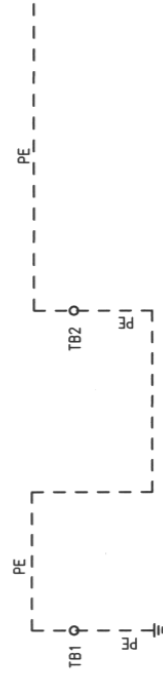
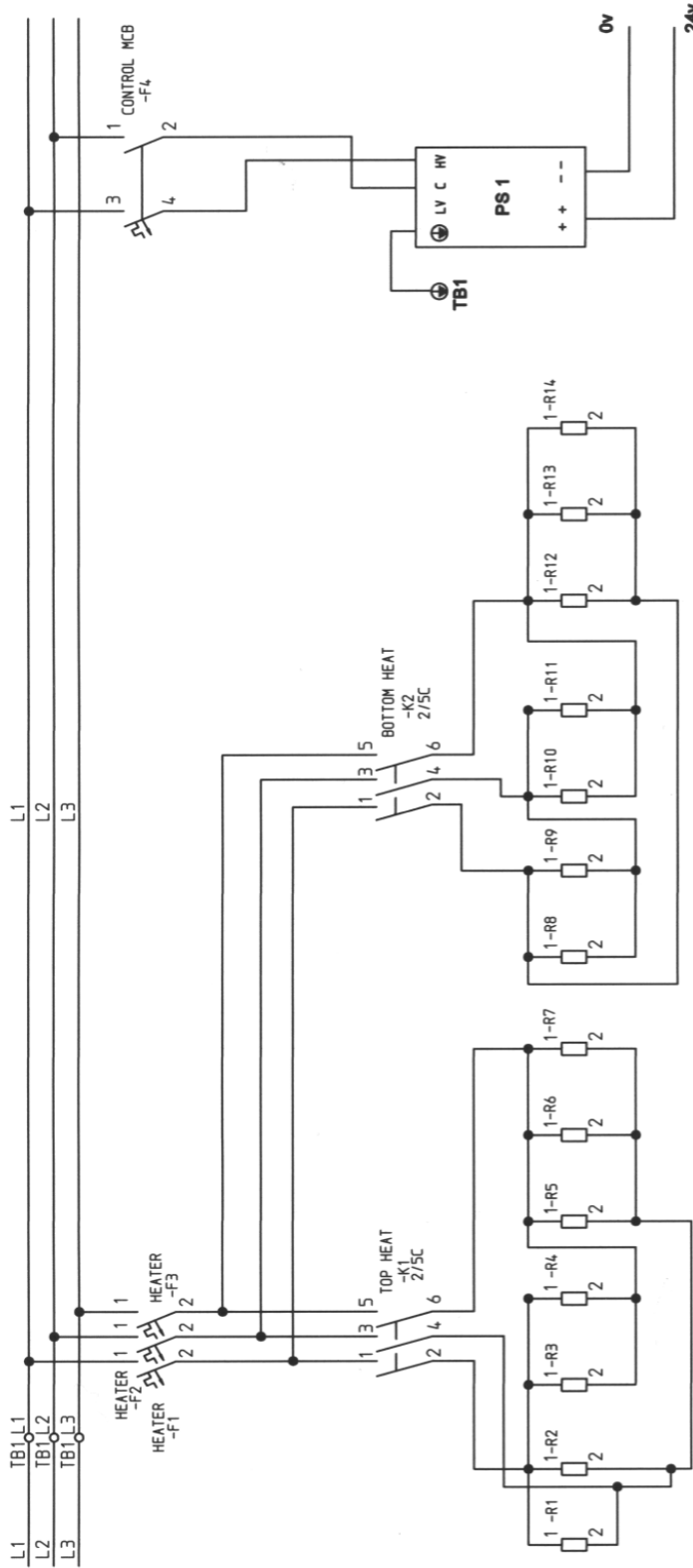

REV	SIG	DATE	REVISION	ECN NO.
			TITLE: MODULAR DECK OVEN POWER CIRCUIT TOP-BOTTOM HEAT	
			UL VERSION	
			DRAWN: RAC	ELECTRICALLY APPROVED BY:- PB/AT
			DATE: 9-10-06	REV: —
			DRAWING NO. M257E25-50800	
MONO EQUIPMENT QUEENSWAY SWANSEA WEST IND PARK SWANSEA, SA5 4EB. TEL: (01782) 561234 SALES SERVICE FAX: (01782) 561016 Email: engineering@monoequip.com				
ELECTRICAL SPECIFICATIONS:- 480V 3 PHASE 60HZ 3 WIRE + GROUND				
COPYRIGHT © 1998 - THIS DESIGN/DRAWING IS THE PROPERTY OF MONO EQUIPMENT LTD. AND MUST NOT BE REPRODUCED, COPIED, NOR ITS CONTENTS DIVULGED WITHOUT PRIOR WRITTEN PERMISSION.				

IF IN ANY DOUBT - ASK

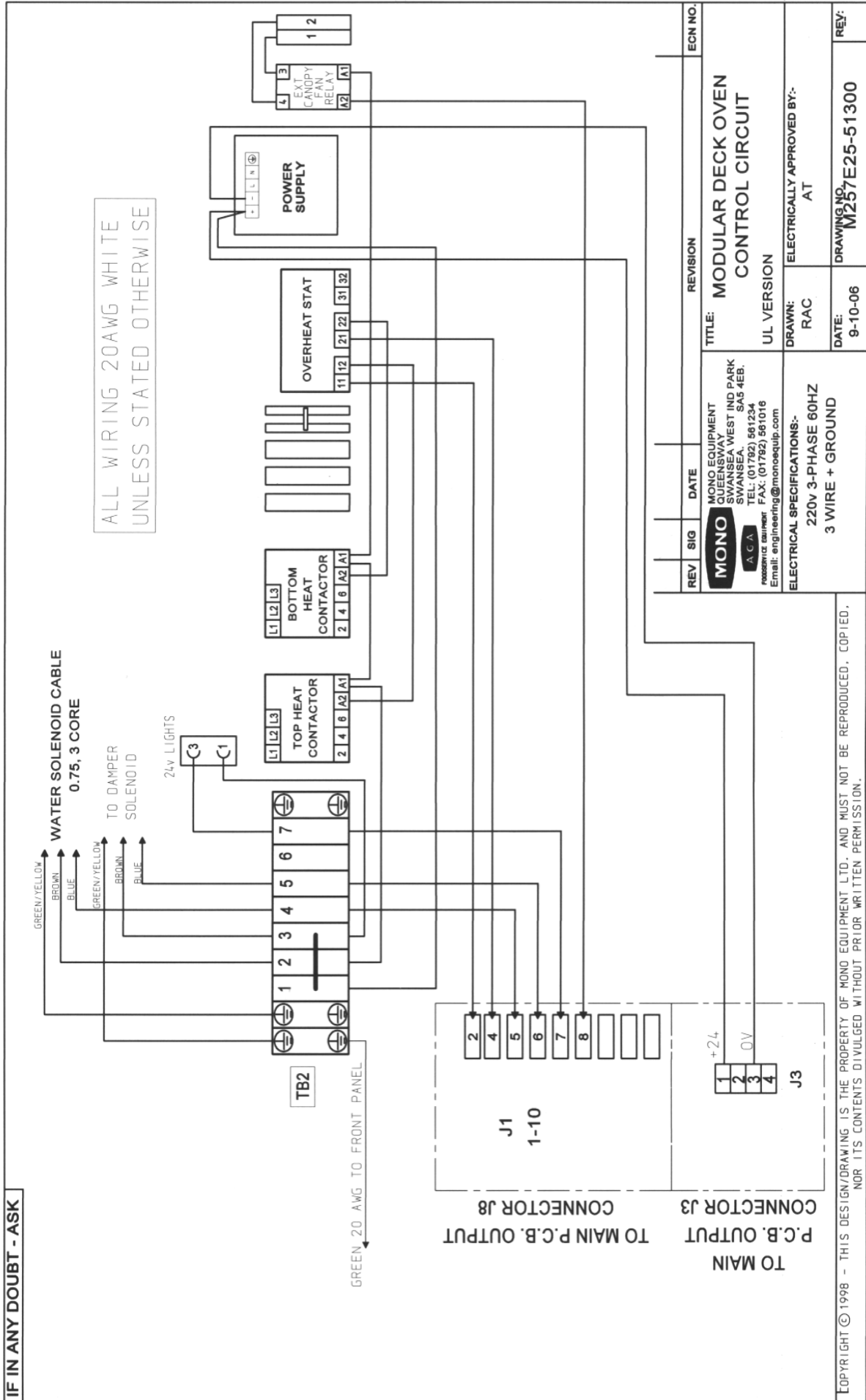

REV	SIG	DATE	REVISION	ECN NO.
			MODULAR DECK OVEN CONTROL CIRCUIT	
MONO EQUIPMENT QUEENSWAY SWANSEA WEST IND PARK SWANSEA, SA5 4EB. TEL: (01782) 861234 FAX: (01782) 861016 Email: engineering@monoequip.com				
ELECTRICAL SPECIFICATIONS:- 220v 3-PHASE 60HZ 3 WIRE + GROUND				
UL VERSION			DRAWN: RAC ELECTRICALLY APPROVED BY:- AT	
DATE: 9-10-06			DRAWING NO. M257E25-51300	REV:

COPYRIGHT © 1998 - THIS DESIGN/DRAWING IS THE PROPERTY OF MONO EQUIPMENT LTD. AND MUST NOT BE REPRODUCED, COPIED, NOR ITS CONTENTS DIVULGED WITHOUT PRIOR WRITTEN PERMISSION.

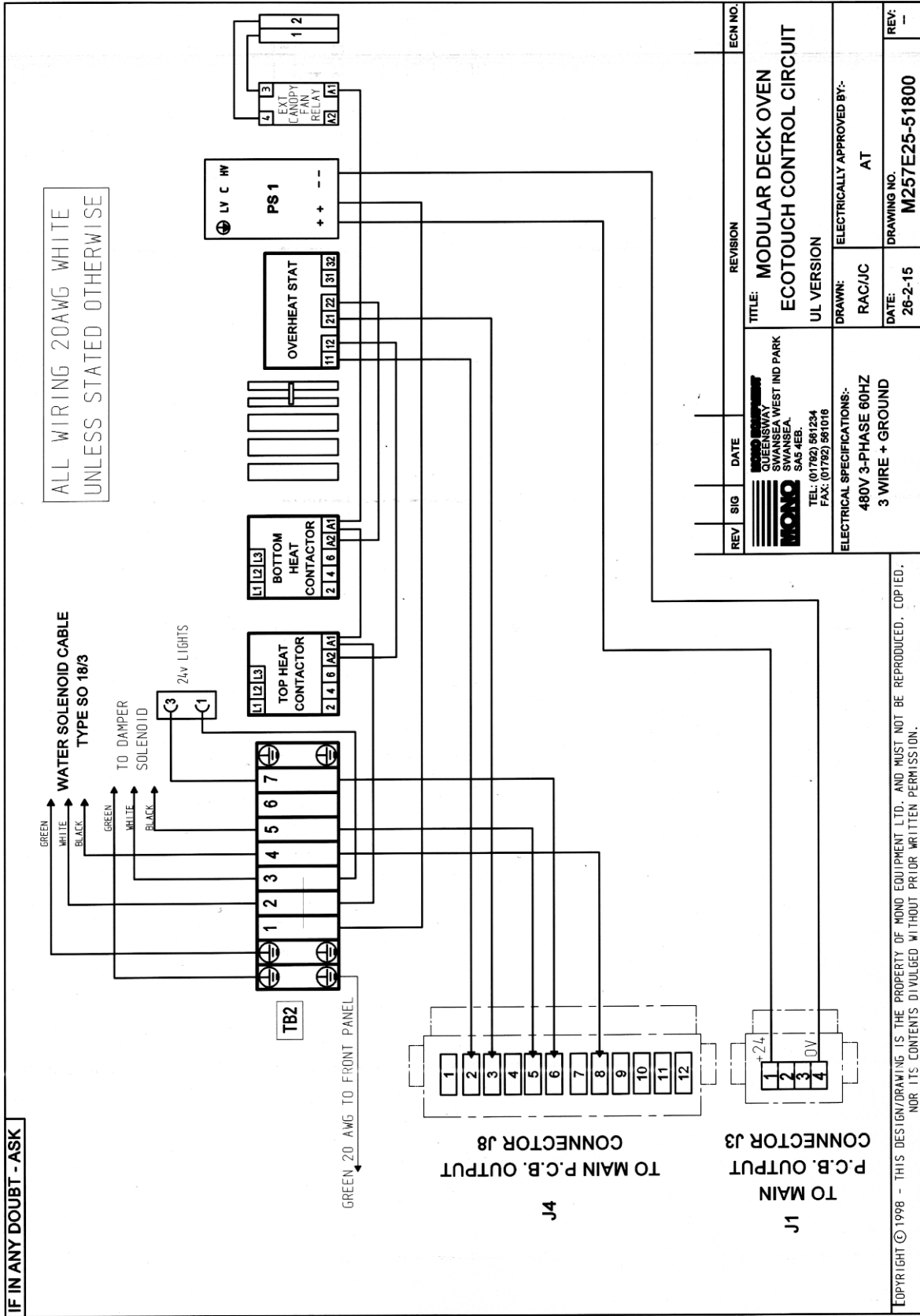

IF IN ANY DOUBT - ASK

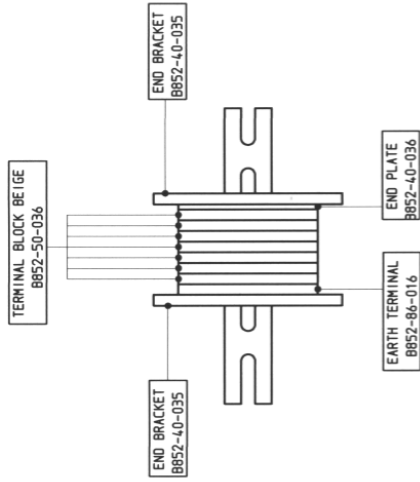

TB2

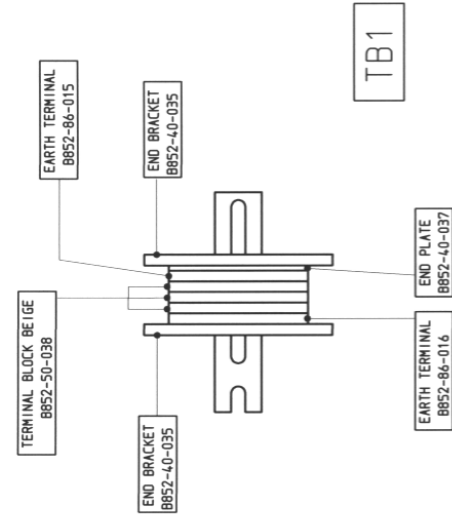

TB1

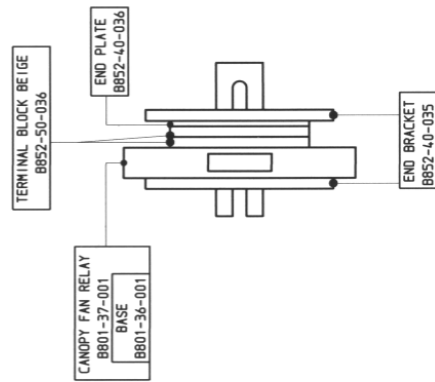

TB3

REV	SIG	DATE	REVISION	ECN NO.
			MODULAR DECK OVEN TB1, TB2, TB3	
MONO EQUIPMENT QUEENSWAY SWANSEA WEST IND PARK SWANSEA, SAS 4EB. TEL: (01792) 861234 TECHNICAL SUPPORT: (01792) 861016 Email: engineering@monoequipment.com			TITLE: MODULAR DECK OVEN TB1, TB2, TB3	
ELECTRICAL SPECIFICATIONS:-			DRAWN: RAC	ELECTRICALLY APPROVED BY:- AT
			DATE: 8-2-07	REV: --
			DRAWING NO. M257E25-504.00	

COPYRIGHT © 1998 - THIS DESIGN/DRAWING IS THE PROPERTY OF MONO EQUIPMENT LTD. AND MUST NOT BE REPRODUCED, COPIED, NOR ITS CONTENTS DIVULGED WITHOUT PRIOR WRITTEN PERMISSION.

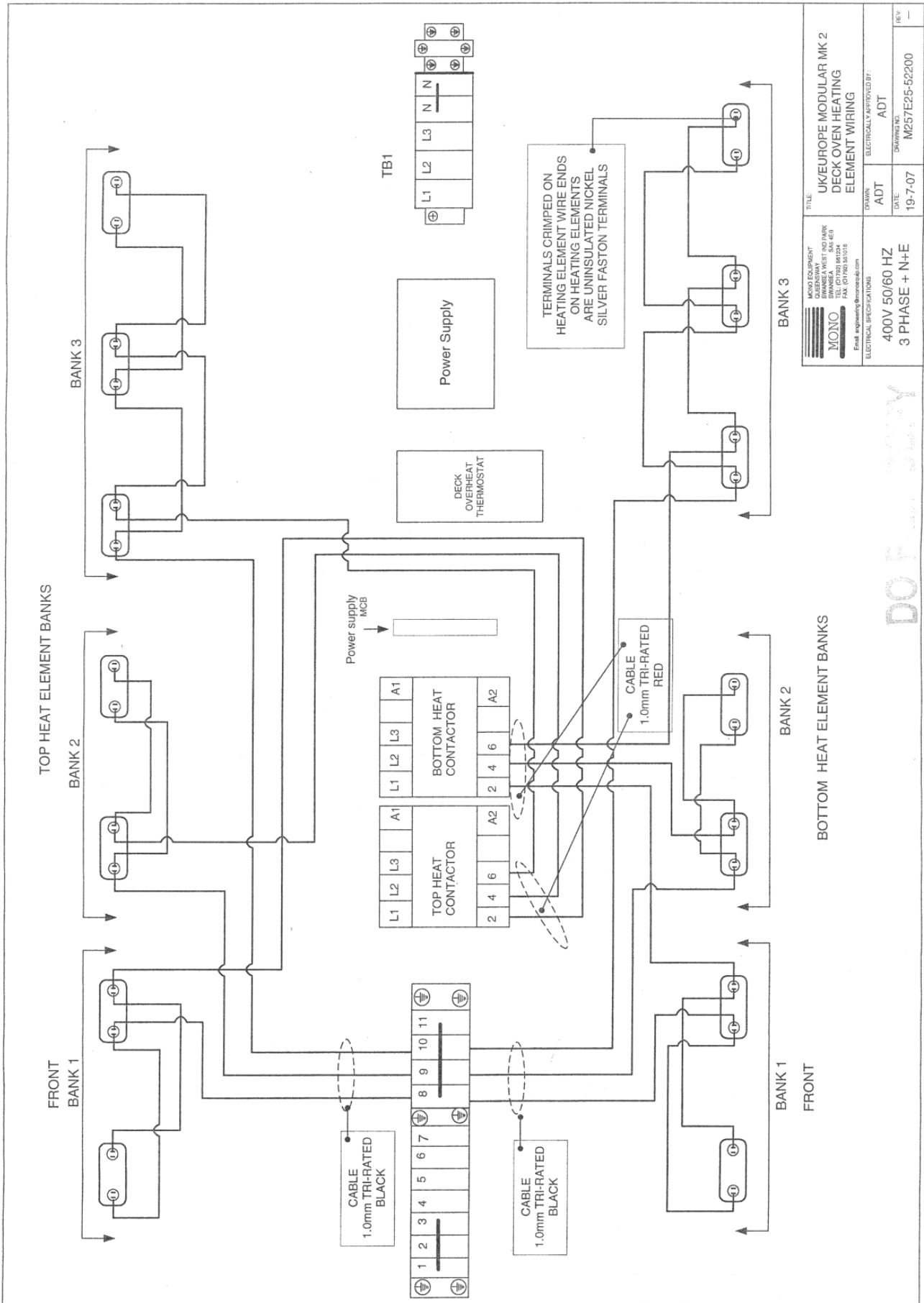

DOF

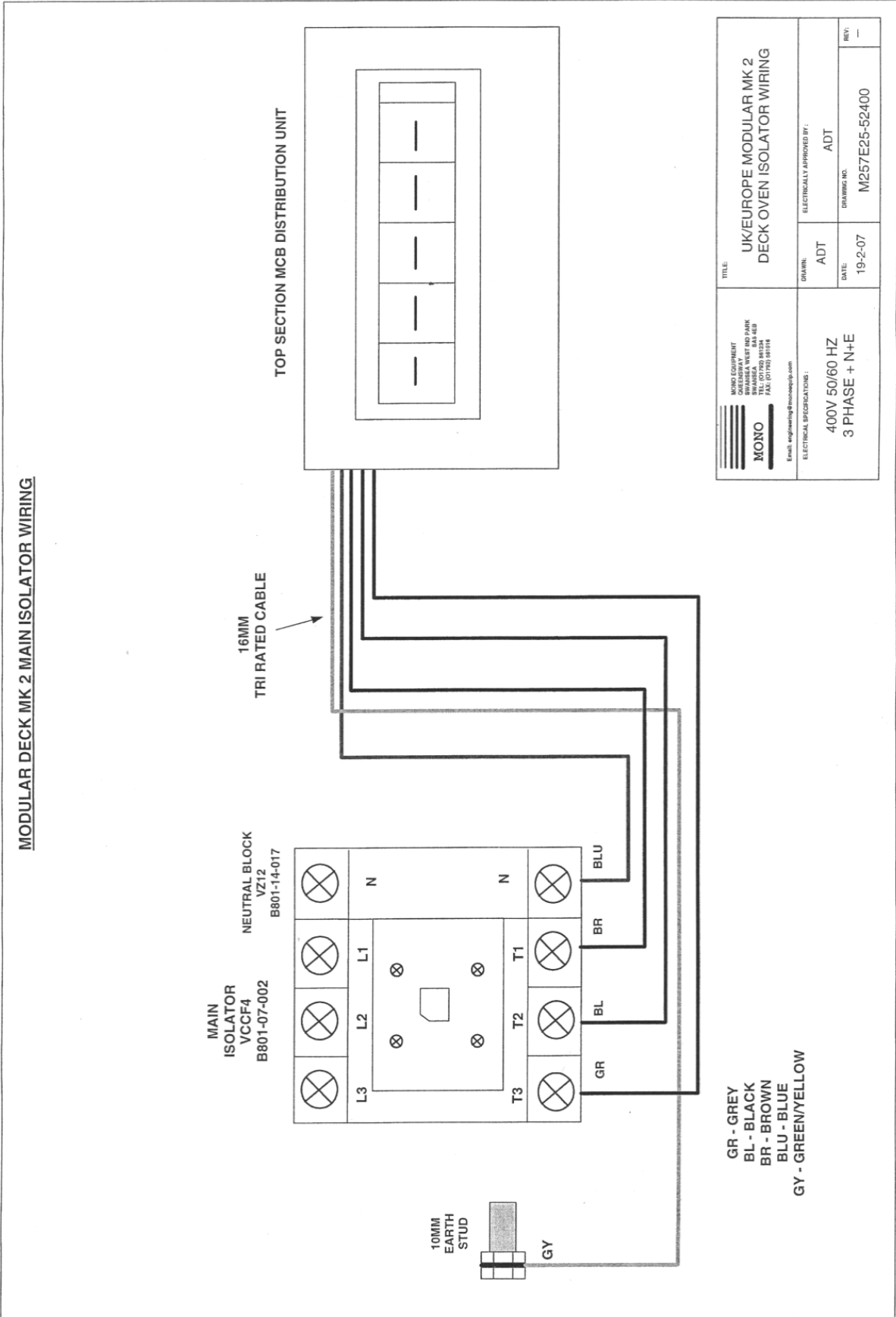

Electrical panel main components

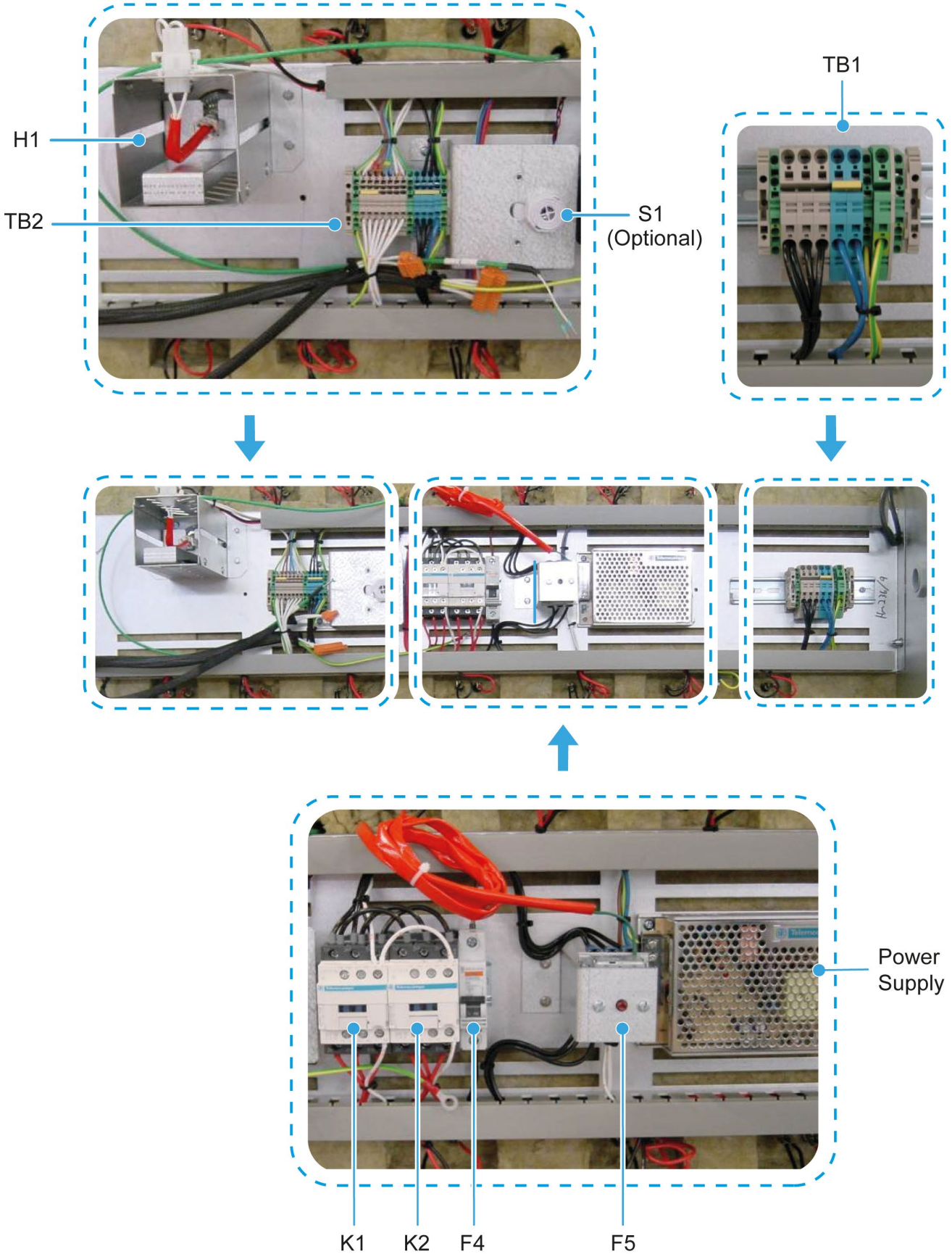
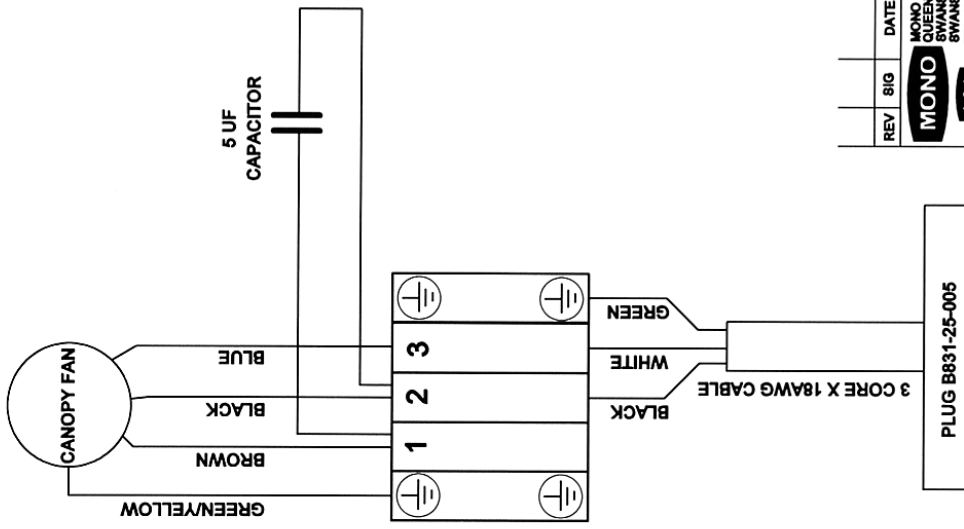

Table 14: Oven canopy layout parts list

Reference	Part description	Part number
C1	Canopy fan capacitor, 5 μ F, 400VDB, metal	B869-23-005
Q1	Canopy fan on/off switch	B895-07-005
M1	Canopy fan motor R2E225-AG01-21 (230V, 1.4 Amp, 305 Watts)	B869-75-026
X1	Extraction fan socket connector	B831-06-006
	Extraction fan plug connector	B831-06-005
	Socket type 5669-C	B831-06-006
	Socket type 5666-C	B831-06-005
	MCB, 2 Pole, 1 Amp, "D"	B872-22-117
	Capacitor, 4-6 uf, 400VDB, Metal	B869-23-005
	Fan type R2E225-AG01-21 (230V, 0.88 Amps, 200 W)	B869-75-026

IF IN ANY DOUBT - ASK



FROM CANOPY CONTROL PANEL

REV	8IG	DATE	REVISION	ECN NO.
			TITLE: MODULAR DECK OVEN CANOPY FAN WIRING UL VERSION	
MONO EQUIPMENT MONO EQUIPMENT GUESHWAY 1000 WEST 110 PARK BIRMINGHAM, AL 35244 TEL: (205) 981-2344 FAX: (205) 981-0118 Email: engineering@monoequip.com			DRAWN: RAC ELECTRICALLY APPROVED BY: PBI/AT	
ELECTRICAL SPECIFICATIONS:-			DATE: 28-4-05	REV: -
			DRAWING NO: M247E25-50600	

COPYRIGHT © 1998 - THIS DESIGN/DRAWING IS THE PROPERTY OF MONO EQUIPMENT LTD. AND MUST NOT BE REPRODUCED, COPIED, NOR ITS CONTENTS DIVULGED WITHOUT PRIOR WRITTEN PERMISSION.

IF IN ANY DOUBT - ASK

MCB 2 POLE 1.0A
B872-22-117

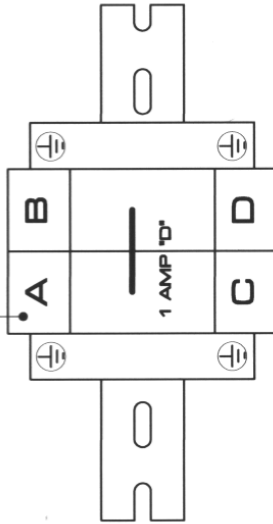

REV	SIG	DATE	REVISION	ECN NO.
			DXM CANOPY CONTROL PLATE ASSY PARTS	
MONO MONO EQUIPMENT QUEENSWAY SWANSEA, SA3 4EB. TEL: (01792) 861234 Fax: (01792) 861016 Email: engineering@monoequip.com			TITLE: UL	
ELECTRICAL SPECIFICATIONS:-			DRAWN: RAC	ELECTRICALLY APPROVED BY:- AT
			DATE: 5-02-07	DRAWING NO. M257E-25-51200
				REV: ---

COPYRIGHT © 1998 - THIS DESIGN/DRAWING IS THE PROPERTY OF MONO EQUIPMENT LTD. AND MUST NOT BE REPRODUCED, COPIED, NOR ITS CONTENTS DIVULGED WITHOUT PRIOR WRITTEN PERMISSION.

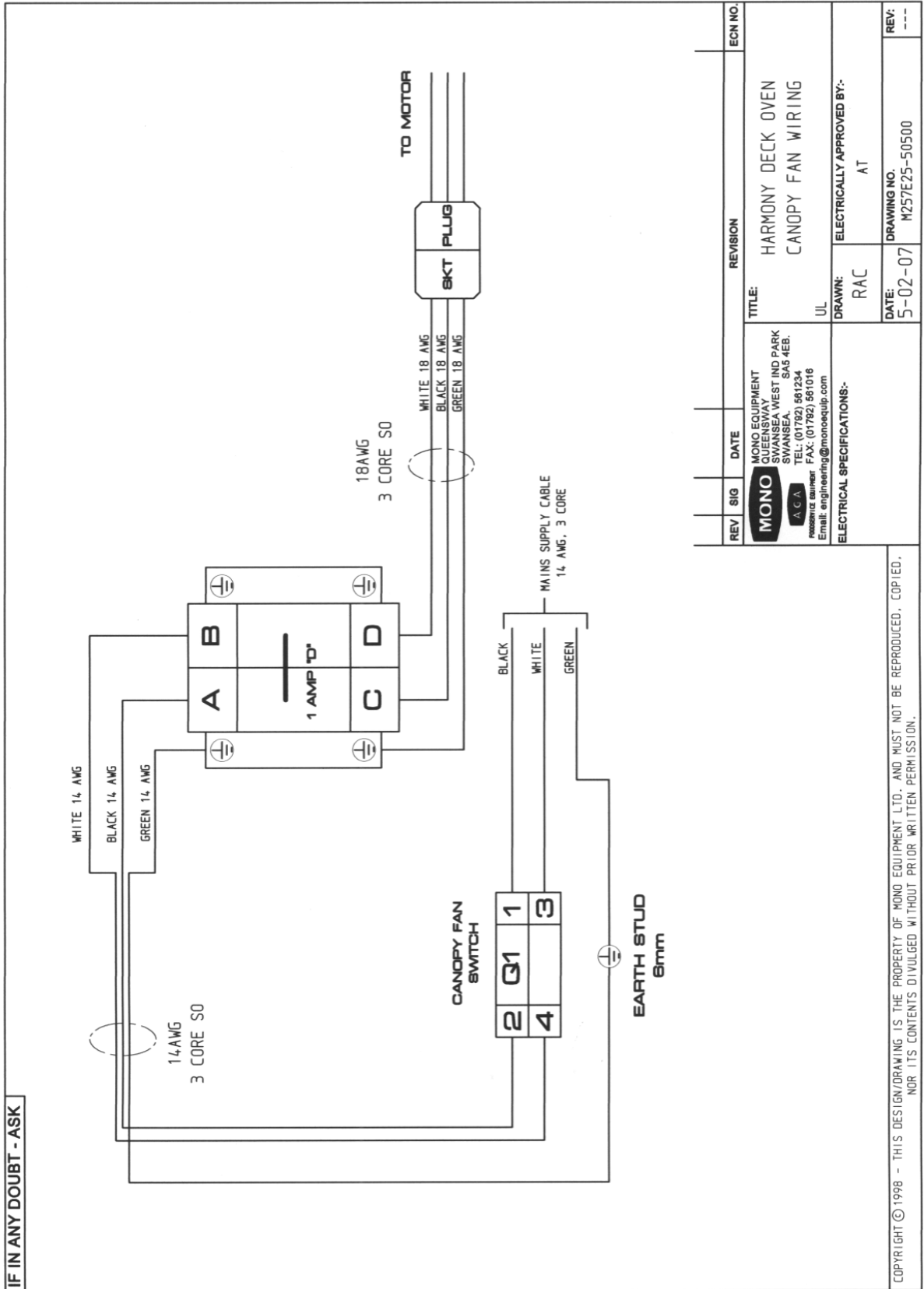

13. Location of Warnings and Information Labels

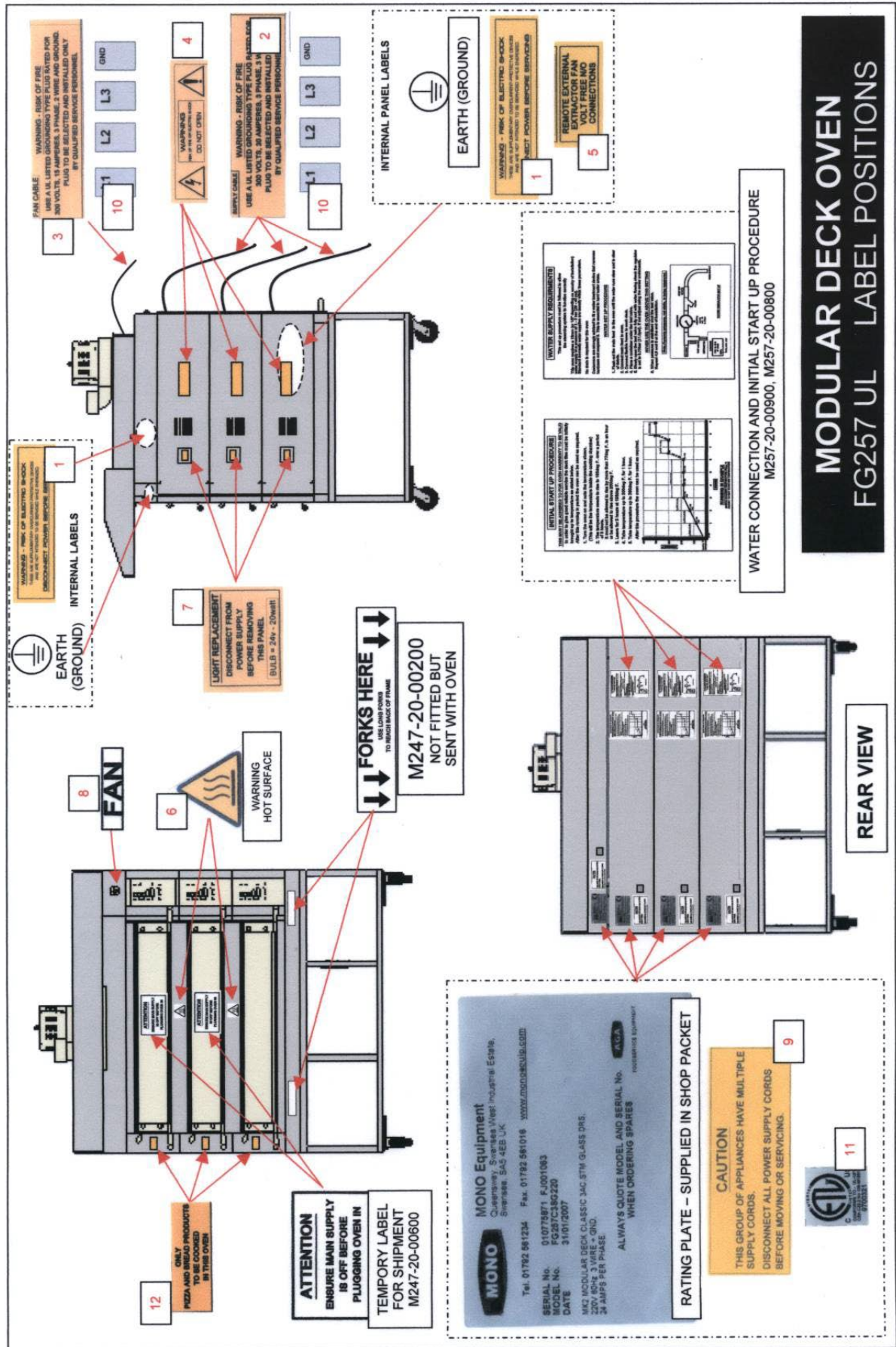

MONO Equipment is the leading designer and manufacturer of bakery equipment in the United Kingdom. This proud heritage of British craftsmanship, combined with a reputation for creating high-quality, innovative products, can be traced back to its origins in 1947.

All our bakery equipment is manufactured to the most stringent NQA ISO9001:2015 & NQA ISO14001:2015 standards and is crafted using the very latest, cutting-edge technology combined with the time-honoured skills of the master craftsman.

MONO Equipment truly excels in providing tailor-made solutions to a diverse range of clients, from the small independent artisan baker to the large retail chains found on every high street and in every out-of-town shopping centre. We can supply everything from a simple Food-2-Go cafe oven to the entire list of bakery equipment needed to set up a full scratch bakery.



MONO Equipment Limited

Queensway
Swansea West Industrial Park Swansea
SA5 4EB

Tel: +44 (0)1792 561 234 (Switchboard)
Tel: +44 (0)1792 564 000 (UK Sales)
Tel: +44 (0)1792 564 004 (International Sales)
Tel: +44 (0)1792 564 048 / +44 (0)1792 564 049 (Spares)
Fax: +44 (0)1792 561 016

Email: sales@monoequip.com
Web: www.monoequip.com



Scan using your smart phone to
view our website.

