

Store this document safely and ensure it is available at all times.  
Non-availability may affect the service / repair of your machine.

MANUAL No.Y-AL-01E

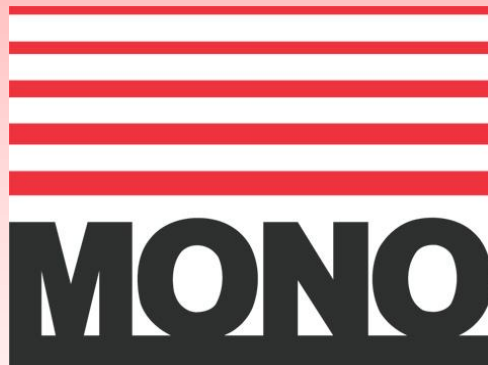
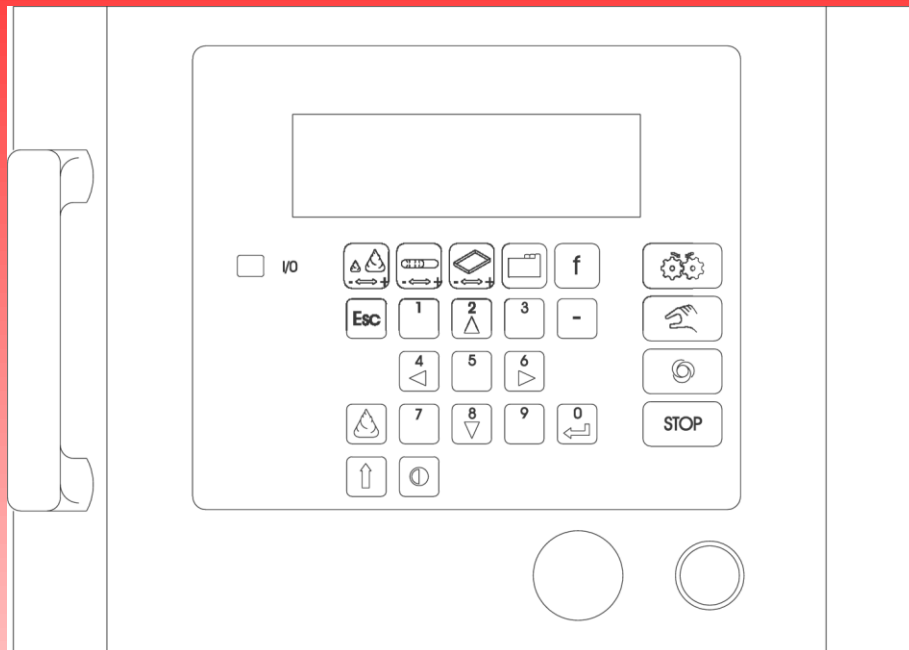

**CONTROLLER OPERATION MANUAL**  
for the  
***ALPHA DEPOSITOR***  
**(Programming Instructions)**

# INDEX

<b>1.0 INTRODUCTION</b>	<b>page 6</b>
<b>2.0 USE OF KEY PAD -- Key functions</b>	<b>page 9</b>
<b>3.0 USE OF MENU SCREENS</b>	<b>page 13</b>

## A) The creation and editing of product programs

1. Drop deposit menu.....	page 13
• Quantity	
• Deposit speed	
• Rotary speed	
• Jog delay	
2. Strip deposit menu.....	page 15
• Initial deposit	
• Product length	
• Product quantity	
• Final deposit	
• Deposit speed	
• Rotary speed	
3. Tray set-up menu.....	page 16
• No. per tray	
• Distance to first	
• Product spacing	
• Tray length	
• Set height	
• Wirecut	
4.Edit / Create menu.....	page 19
• Move	
• Deposit pump (axis 0)	
• Tray conveyor (axis 1)	
• Speed	
• Wait	
• Delete	

## **B) Memory facilities**

1. Memory menu.....page 23
  - Save
  - Save new program
  - DELETE item
  - Sort
  - DELETE directory
2. Product select.....page 26
  - Existing programs
  - New drop products
  - New strip products
  - Other new products
3. Run menu.....page 27
4. Delete menu.....page 27
  - Clear counter
  - Delete product

## **C) Machine set-up & diagnosis**

1. Speed set-up.....page 28
  - Deposit speed
  - Table speed
  - Rotary speed
  - Initial tray velocity
  - Maximum acceleration limit
  - Jog down Acceleration
  - Jog up acceleration
2. Offset menu.....page 30
  - Soft dough
  - Hard dough

**3. Set-up and diagnostics.....page 30**

- Set time
- Set date
- Test DACS menu
- Keypad test
- Inputs test
- Exit to operating system
- Loading new program

**4. Initial checks.....page 34**

**5. Field set-up.....page 35**

- Amplifier replacement
- Inverter unit (rotary head)

**6. PASSWORD set-up screen.....page 37**

**7. Screen warnings.....page 37**

**CONVERSION FROM OPTIDRIVE TO ALTIVAR 11 INVERTER**

<b>4.0 NOZZLE IDENTIFICATION RECORD SHEET</b> page 38
---

Keep a record of I.D.no. and nozzle descriptions.

# 1.0 INTRODUCTION

This manual covers all functional aspects of the **ALPHA** depositor that can only be addressed through data entry into the electronic controller situated on its control pod. Such aspects include product creation, product program storage into memory and retrieval, program deletion, machine set-up and diagnostics display.

As such, this manual forms a necessary accompaniment to the **ALPHA**'s Operation and Maintenance Manual to impart the complete and necessary information to the user and maintenance engineer for successful and safe use of the **ALPHA**.

Data entry into the controller is via the membrane covered key switch keypad and the prompted menu-driven LCD screen display allowing word processor type entry.

All menu screens are logically arranged in hierarchical order and by reference to Fig 1a and 1b, the relative location of screens can be clearly seen.

*Included in Fig1a and 1b are details of screens which the user will not require normal access to. These screens are made use of by **MONO**'s production and maintenance engineers and provide a convenient means of displaying information regarding machine set-up. They are consequently password protected for **MONO** use only.*

Prior to taking delivery of the **ALPHA** depositor, all controller aspects regarding machine set-up will have been performed at **MONO**'s factory. Once commissioned, the **ALPHA** will be ready for use with all necessary adjustments made. From this point the user need mainly concern himself with the **ALPHA**'s functional aspects of creating and storage of a product library.





Fig 1b Alpha Depositor menu structure

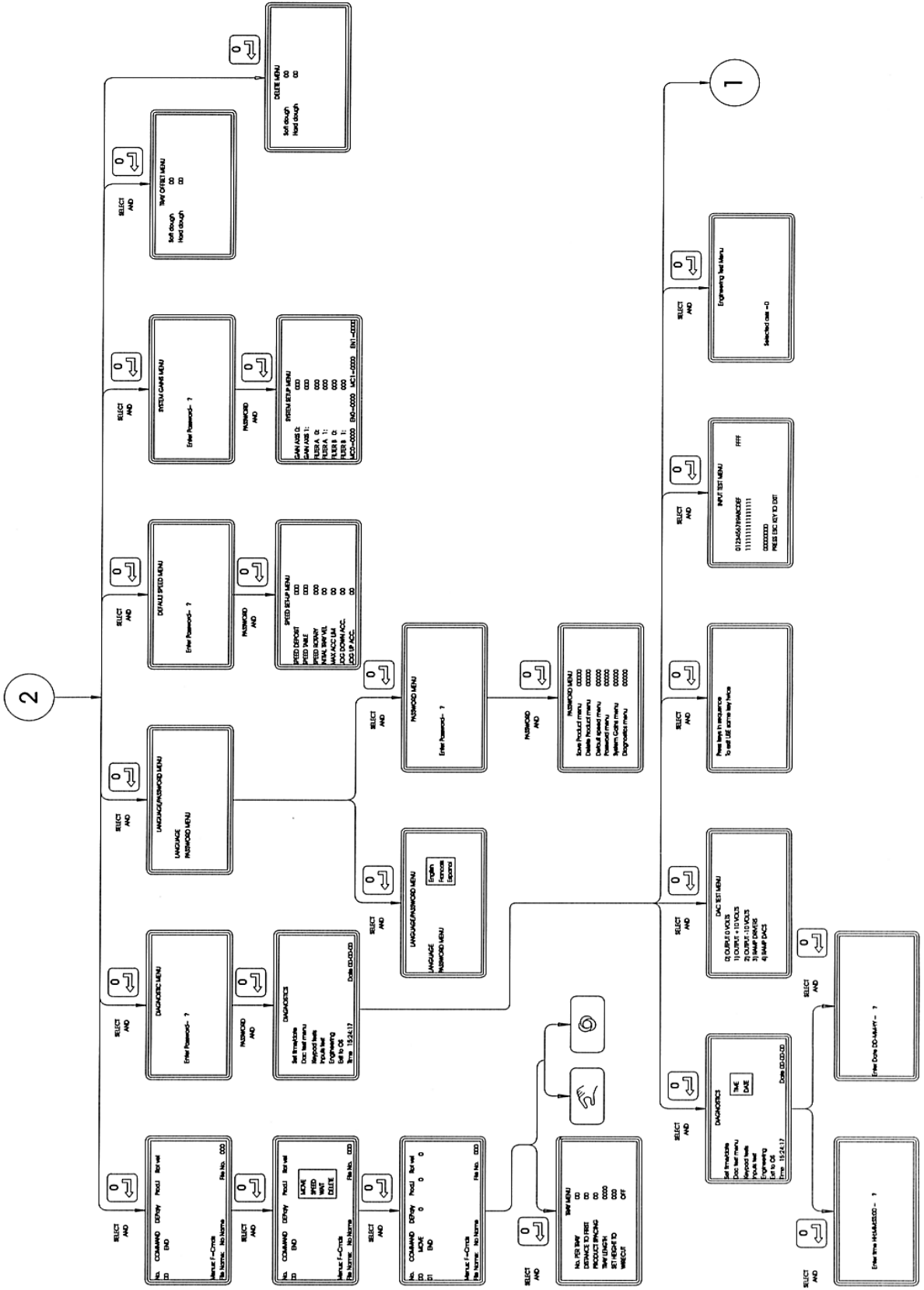



## 2.0 USE OF KEYPAD

Fig 2. Shows the **ALPHA**'s controller keypad and LCD screen.

The five keys immediately below the controller's LCD screen are menu option keys. Selecting these will gain the user access to the relevant menus.

Data entry into the controller is by use of the directional / numerical keys (G), - key (R), and enter key ↵. Selection of value to be entered is by use of directional keys, holding down the shift key (I) and pressing the numerical keys will enable the user to enter a figure. Exit to a higher screen is by use of the escape (K) key, generally in accordance with Figs.1a and 1b.

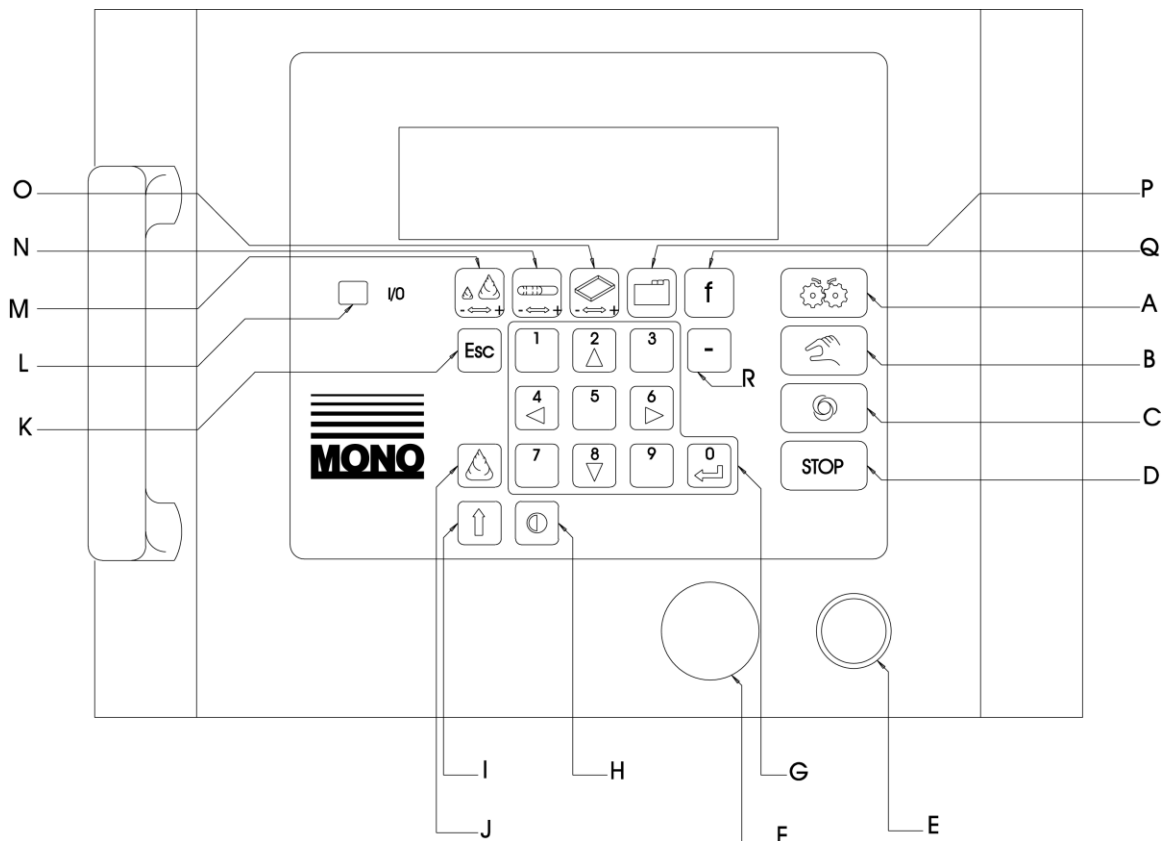

**Fig 2.0 - ALPHA Control panel**

## DESCRIPTION OF CONTROL PANEL - KEY FUNCTIONS

<u>DRG REF.</u>	<u>FUNCTION</u>	<u>DESCRIPTION</u>
<b>A</b>	<b>PRIME</b>	<p>This button activates the hopper pump for as long as it is pressed, providing either a product creation or run menu are on screen, and all safety guards are properly closed. It fulfils two functions: -</p> <p><b>a.</b>To prime the hopper pump and nozzles with product mix.</p> <p><b>b.</b>Aids the engagement of the hopper drive gear into the drive shaft.</p>
<b>B</b>	<b>MANUAL</b>	<p>Runs product program for one tray only, then returns tray to operator and stops. If a tray is already under the deposit pump, by pressing "manual" the tray will be returned to you.</p>
<b>C</b>	<b>AUTOMATIC</b>	<p>Activates an automatic machine cycle provided a tray is on the table and positioned correctly. At the end of the cycle, the tray conveyor will continue running to move the full tray from the machine and introduce an empty tray to the deposit start position</p> <p><b>NOTE</b> <i>If two trays are placed too close to each other, the machine will interpret this as one long continuous tray and will continue feeding both trays through the machine until a gap at the rear of the following tray is detected.</i></p>
<b>D</b>	<b>STOP BUTTON</b>	<p>Stop button for either the manual or automatic modes. Stops machine cycle but does not cut power to drives.</p>

**E**

**START BUTTON**

**Pressed once** will power up controller screen. **Pressed a second time** will activate all power electric circuits. All machine facilities can be used once pressed provided all safety guards are properly closed and emergency stop button is released.

**F**

**EMERGENCY STOP**

Immediately isolates all power circuits.  
To release - turn clockwise.

**G**

**NUMERIC/DIRECTION**

Whilst key (I) is being held down these BUTTON keys will allow entry of numerical values. If pressed by themselves they can be used for cursor movement and command activation.

**H**

**CONTRAST**

If pressed simultaneously with key (I) and then released, by using keys (I) and (H) the contrast of the screen can be changed. Five seconds after release the new setting will be fixed.

**I**

**SHIFT BUTTON**

If used in conjunction with (G) keys will allow numerical entry. Used for adjusting contrast (as above).

**J**

**SINGLE DEPOSIT  
BUTTON**

When in a program creation menu pressing this will run program to do a single row on a tray, then return the tray.

**K**

**ESCAPE**

Enables exit from menus to higher levels and exit from current on screen operations.

**L**

**POWER INDICATOR**

When illuminated all electric circuits have been activated.

**M**

**DROP PRODUCT MENU**

Selects screen menu for creation of drop products i.e. products with no length.

**N**

**STRIP PRODUCT MENU** Selects screen menu for creation of strip products i.e. products with length.

---

**O**

**TRAY MENU** Selects screen menu to enter values for positioning of product on tray.

---

**P**

**FILE MENU** Selects screen menu to save, retrieve and delete programs.

---

**Q**

**FUNCTION MENU** Selects screen menu to enter edit/create menu and machine set-up menus.

---

## 3.0 USE OF MENU SCREENS

Refer to Figs 1a and 1b.

The controller functionality can be split up into three areas of machine use: -

### a) The creation and editing of product programs

1. Drop deposit menu
2. Strip deposit menu
3. Tray set-up menu
4. Edit/Create menu

### b) Memory facilities

1. Memory menu
2. Product select menu
3. Run menu
4. Delete menu

### c) Diagnostics and machine set-up.

## a) CREATION AND EDITING OF A PRODUCT PROGRAM

When creating a new program, data entry into 2 separate menus has to be achieved – Tray set-up menu with either drop or strip and edit/create menu. Information contained within all these menus is stored in the controller's memory for each product program. Upon switching on of the ALPHA depositor by means of the start button (E), the controller LCD screen will be displaying the program selection menu. To edit a program or simply run a program, selection must be made by means of the up and down arrow keys and entered.

### Program selection menu

000	COOKE	014
001	NO NAME	
002	NO NAME	
003	NO NAME	

SCROLL PROGRAMS USING ARROW KEYS  
PRESS ENTER TO SELECT  
TIME: 13:17:02 DATE: 06-11-98

## 1. DROP DEPOSIT MENU

A Drop product is a product that is considered to have no length e.g. no tray movement during a deposit. For creation of a new drop deposit, simply press the drop deposit menu key (M) when switching on the machine.

### Drop deposit menu

DROP DEPOSIT MENU	
QUANTITY	0000
DEPOSIT SPEED	000
ROTARY SPEED	000

USE ARROW KEYS TO SELECT ITEM

- **QUANTITY**

Enter a positive numerical reading to achieve rotation of the deposit pump and a quantity of product mix extruded through the selected template assembly. The entered value is proportional to the amount of pump rotation but is, by necessity, uncalibrated in product mix quantity terms as any attempt to do so would be inaccurate should the template arrangement, product mix or pumping speed change.

To increase the amount deposited move the cursor onto the value using the up and down arrow keys as appropriate, and enter a new value whilst holding down the shift key. If a zero value is entered the value will default to a minimum value.

- **DEPOSIT SPEED**

The speed command sets a maximum speed value to the motor driving the deposit head (up to a preset maximum) during the product creation sequence of movements only, not prior, in between or after each of the deposited rows on the tray. If a value, which exceeds the motors maximum speed, is entered the machine will automatically enter the default value. The user chosen value, when entered, will represent a proportionate amount of the full speed value.

- **ROTARY SPEED**

When activated the rotary will start as soon as a tray is detected and will run continuously until the tray has been completed. With this speed command set to zero the rotary will be switched off. Using a rotary template, entering a value for the speed will enable the rotary. The rotary speed value will default to zero when creating a new program i.e. with the rotary off. The rotary speed can be increased in small increments up to the default maximum.

When using offset nozzles for creating rings for example, the product quantity must be varied simultaneously with the rotary speed in order to obtain the correct position for the beginning and end of the ring.

- **JOG DELAY**

When 'on' is selected, there will be a delay after each deposit, before the table jogs down. The rotary will continue during this delay in order to remove deposit tails when producing rings

Using < and > the jog delay can be toggled ON and OFF. A value can also be entered using the shift key; this can be done if a longer delay is required.

## 2. STRIP DEPOSIT MENU

A Strip product is a product that is considered to have length e.g. the tray will continue to move while depositing. For creation of a new strip product simply press the strip deposit menu key upon switching on the machine.

The creation of a strip product consists of three separate steps, an **initial deposit**, a **strip deposit** and a **final deposit**. The initial and final deposits can be varied to produce the type of product end you require.

### Program selection menu

STRIP DEPOSIT MENU	
INITIAL DEPOSIT	000
PRODUCT LENGTH	000
PRODUCT QUANTITY	0000
FINAL DEPOSIT	000
DEPOSIT SPEED	000
ROTARY SPEED	000

- **INITIAL DEPOSIT**

Enter a positive numerical Value along side the 'Initial deposit' heading to achieve rotation of the deposit pump and a quantity of product mix extruded through the selected template assembly. The entered value is proportional to the amount of pump rotation but is, by necessity, uncalibrated in product mix quantity terms as any attempt to do so would be inaccurate should the template arrangement, product mix or pumping speed change.

To increase the amount deposited move the cursor onto the value using the up and down arrow keys as appropriate, and enter a new value whilst holding down the shift key.

The entered value will produce a single drop deposit at the beginning of the desired strip product. By means of increasing or decreasing this value the shape of the product end can be varied.

- **PRODUCT LENGTH**

Enter a positive numerical value to achieve horizontal movement of the tray conveyor in a direction away from the operator and control panel. The entered value is the length of the product, measured in millimetres.

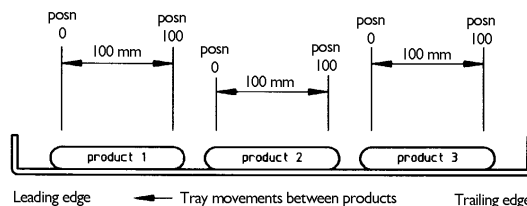

### Product length illustration

- **PRODUCT QUANTITY**

The entered value is proportional to the quantity of product mix extruded equally over the product length. To increase the amount deposited move the cursor onto the value using the up and down arrow keys as appropriate, and enter a new value whilst holding down the shift key.

- **FINAL DEPOSIT**

The entered value will produce a single drop deposit at the end of the desired strip product. By means of increasing or decreasing this value the shape of the product end can be varied.

To increase the amount deposited move the cursor onto the value using the up and down arrow keys as appropriate, and enter a new value whilst holding down the shift key.

- **DEPOSIT SPEED**

The speed command sets a maximum speed value to the motor driving the deposit head (up to a preset maximum) during the product creation sequence of movements only, not prior, in between or after each of the deposited rows on the tray. If a value, which exceeds the motors maximum speed, is entered the machine will automatically enter the default value. The user chosen value, when entered, will represent a proportionate amount of the full speed value.

- **ROTARY SPEED**

When activated the rotary will start as soon as a tray is detected and will run continuously until the tray has been completed. With this speed command set to zero the rotary will be switched off. Using a rotary template, entering a value for the speed will enable the rotary. The rotary speed value will default to zero when creating a new program i.e. with the rotary off. The rotary speed can be increased in small increments up to the default maximum.

Within the Strip product menu, the rotary could be used for adding spiral affect to an éclair type product.

**3. TRAY SET-UP MENU**

Consideration needs to be given to the trays onto which the product(s) are to be deposited and the head and the table motion between each product on the tray. These relevant and important factors are all addressed in the Tray set-up menu.

To enter a figure, move the cursor onto the value using the up and down arrow keys as appropriate, and enter a value whilst holding down the shift key.

TRAY MENU	
No. PER TRAY	00
DISTANCE TO FIRST	00
PRODUCT SPACING	00
TRAY LENGTH	0000
SET HEIGHT TO	000
WIRECUT	OFF

Tray set-up menu



- **NO PER TRAY**

The number of repeated rows of deposited product required along the tray's length.

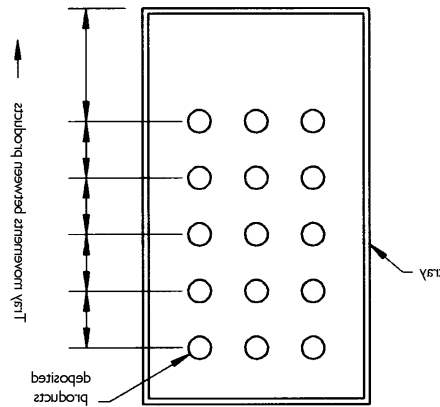

**NOTE** - this value does not correspond to the number of products deposited across the tray, i.e. the number of nozzles on the template in use.

- **DISTANCE TO FIRST**

The distance in millimetres from the leading edge of the tray to the first deposited product row on the tray.

- **PRODUCT SPACING**

The distance in millimetres between each deposited product row.

- **TRAY LENGTH**

The length, in millimetres, of the tray being used for the depositing of products. Dimension of tray to be considered is that in the direction of tray conveyor travel.

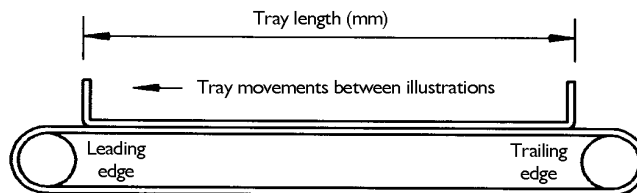

**Tray length illustration**

**IMPORTANT** - No automatic tray length detector exists on the ALPHA and this programmed length value is stored in the controller's memory for the particular product in question. Hence, it is imperative that no tray with a length shorter than the programmed value is used, otherwise damage to the machine may result and the controller will be unable to complete it's full program. Use of longer trays than the programmed value will result in inefficient use of trays with the last deposit being positioned somewhat further away from the tray's edge than its leading edge.

- **SET HEIGHT**

The value entered here is a **reminder value**. The table height adjustment handle should be set to this height.

**NOTE** - The table **height adjustment is a manual adjustment** and therefore not being controlled by the controller. Care must be taken to set the table to the correct height before commencing operation of the machine, to prevent any damage being done to the tray's being used. For creation of a new product table height should be set to it's lowest position before running the machine, then table adjustment can be done while the machine is running.



**Table height adjuster**

- **WIRECUT**

The operation of the wirecut mechanism can be selected, using the arrow keys to toggle between ON and OFF.

**NOTE!** IF WIRECUT IS SELECTED ON THEN THE WIRECUT MECHANISM WILL OPERATE AFTER EACH INDIVIDUAL DEPOSIT, BUT ONLY IF A WIRECUT TEMPLATE IS CORRECTLY FITTED.

**WARNING!** USE FLAT TRAYS WITH NO EDGES OR ENSURE TABLE HEIGHT IS SET TO A HEIGHT WHERE WIRECUT WILL NOT COLLIDE WITH ANY TRAY EDGES

## 4. EDIT/CREATE MENU

The third product creation screen is the **edit/create** screen. This screen is used for the creation of slightly more complicated products that would not be possible to create in the drop or strip product menus.

With this screen consideration needs to be given to the product program.

The product program is the sequence of events and command instructions, imparted via the controller and the user written program necessary to describe the simultaneous and related movements of the **ALPHA**'s two axes to deposit one product row only.

### Edit/create men

No.	COMMAND	DEPty	Prod.I	Rot vel
00	END			

Menu: F=Cmde  
File Name: No Name File No. 000

The value programmed in the tray set-up menu then repeats the individual product program. Creating a product program requires the appropriate use of available commands along with numerical data entry to describe simultaneous machine movements as applicable to each of the drives.

The available machine movement commands are as follows: -

**MOVE**  
**SPEED**  
**WAIT**  
**DELETE**

No.	COMMAND	DEPty	Prod.I	Rot vel
00	END			

Menu: F=Cmde  
File Name: No Name File No. 000

MOVE  
SPEED  
WAIT  
DELETE

To invoke any of the above commands, use the function key once the **edit/create** menu is current.

The available commands will appear on a pop up menu on the existing edit/create menu screen. Use the up and down arrow keys to move the cursor onto the command required and press the enter key to select.

The command will be inserted into the main program above the line that the cursor is currently on, so the cursor needs to be positioned correctly **before** the introduction of a new command into the program. To remove the pop up menu commands from the edit/create menu, position the cursor on the line to be deleted and then select delete from the pop up menu.

The rules for correct data entry and the effect of each of the commands are outlined next.

- **MOVE**

A Move command will instruct each of the motors associated with the axes to start to move and to finish simultaneously.

By appropriate programming each axis's motor may also be made to remain stationary. The table drive can even be made to move in reverse to its normal forward movement when carrying out its move command.

**SPECIAL NOTE** - The very first move line on any product program is preceded by an unseen program line, which is automatically introduced by the **ALPHA**'s controller and is not printed out on screen. This line sets the start positions for all axes and obviates the need for the user to do so. All move start values are set to zero.

### **DEPOSIT PUMP (Axis 0)**

– enter a positive numerical value under the 'Dep qty' column on the MOVE command line to achieve rotation of the deposit pump and a quantity of product mix extruded through the selected template assembly. The entered value is proportional to the amount of pump rotation but is, by necessity, uncalibrated in product mix quantity terms as any attempt to do so would be inaccurate should the template arrangement, product mix or either pumping speed change.

To increase the amount deposited at any particular stage in the product depositing sequence, move the cursor onto the value to be edited by using the up, down, left and right arrow keys as appropriate, and enter a new value.

### **TRAY CONVEYOR (Axis 1)**

– enter a positive numerical value under the 'Prod L' column on the MOVE command line to achieve horizontal movement of the tray conveyor in a direction away from the operator and the control panel. The entered value is the horizontal position; measured in millimetres, relative to the initial start position for each product, which is regarded as position zero.

**IMPORTANT** - on a multi line product program consideration needs to be given to the value entered in the previous MOVE command line, as the tray will be progressed from this position to its new position as measured from position zero.

- **SPEED**

The speed command sets maximum speed values, up to preset maximum values, to each of the motors linked to the ALPHA'S 3 axes during the product creation sequence of movements only, not prior, in between or after each of the deposited rows on a tray. The SPEED command is inserted into the product program just prior to the MOVE command that it is to 'speed' control and all other MOVE commands, unless superseded by another SPEED command at a later point in the product program. Consequently, the SPEED command will be the first command of a product program but it can be used repeatedly throughout any program.

Upon initially invoking the SPEED command into the product program, the maximum allowable values to drive each axis at full speed are automatically entered and displayed. The user chosen value, when entered, will represent a proportionate amount of this full-speed value.

When activated the rotary will start as soon as a tray is detected and will run continuously until the tray has been completed. **With the rotary speed command set to zero the rotary will be switched off.** Using a rotary template, entering a value for the speed will enable the rotary. The rotary speed value will default to zero when creating a new program i.e. with the rotary off. The rotary speed can be increased in small increments up to a default maximum.

**NOTE!** - Special consideration needs to be given to the application and effect of the SPEED command when more than one axis is moving. Since both of the two axes may be required to move simultaneously, then such axes must start and finish at the same time – the controller achieves this automatically.

If the programmed value for any one of the moving axes represents a large amount of rotation for its motor compared to the other, then it is the motor with this large amount of rotation that will dominate events.

The SPEED value entered for this dominant axis will be achieved and the other axes involved in the simultaneous movement being performed will have their speed automatically compensated for so that all axis movements start and finish together.

So to affect any control on the speed of events during product creation, the dominant axis must be identified and its SPEED value altered accordingly.

If no SPEED command is entered into the product program, then the controller will automatically use the default values as set in the 'speed set up' menu.

- **WAIT**

The WAIT command allows the introduction of a period of inactivity (i.e. no movement) at any point during the product creation program. The command, allowing WAIT periods in increments of 1 second, can be used to allow the complete depositing of mix before continuation onto the next deposit.

- **DELETE**

The DELETE command permits editing of the product program by allowing deletion of any one of the above commands from the program one line at a time.

**Prior to invoking the DELETE command the cursor must be on the command that is to be deleted.**

## B) MEMORY FACILITIES

### 1. MEMORY MENU

Access to the controller's memory facilities is via the **ALPHA'S** file menu key (P). Within this menu the **ALPHA'S** memory will allow you to do the following: -

- **SAVE**
- **SAVE NEW PROGRAM**
- **DELETE ITEM**
- **SORT**
- **DELETE DIRECTORY**

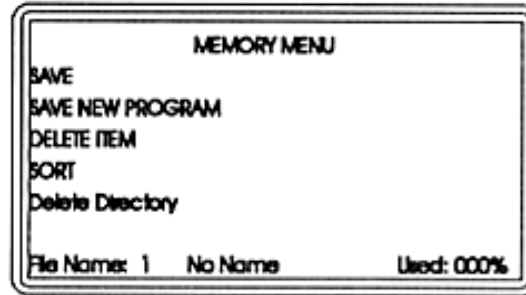

#### Memory Menu

- **SAVE**

Enables the overwriting of an existing product program, it being replaced with an edited version of the original but saved under the same name.

Edited data contained within any of the menus that fully define the product program i.e. DROP and TRAY MENU, STRIP and TRAY MENU or EDIT/CREATE and TRAY MENU can be overwritten to the existing program.

Select SAVE by using the up and down arrow keys and then pressing enter will reveal the instruction 'Enter password'. To enter the password, use the numerical keypad while simultaneously pressing the SHIFT key. Upon entering the password a further check screen, which allows the overwrite operation to be aborted, is then invoked. Press the appropriate left or right arrow key to accept or prevent the procedure.

**NOTE!** - This procedure, as with others, is password protected to avoid accidental use and misuse.

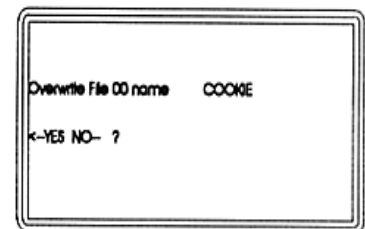
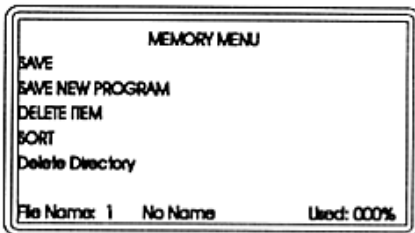

|

## • SAVE NEW PROGRAM

Enables the addition of a new product program (item) to the controller's existing directory.

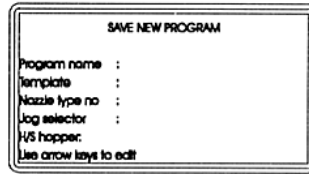

```
SAVE NEW PROGRAM
Program name :
Template :
Nozzle type no :
Jog selector :
H/S hopper:
Use arrow keys to edit
```

Select SAVE NEW PROGRAM by using the up and down arrow keys and then pressing enter. This will reveal the prompt 'Program name.

Using the up and down arrow keys scroll through the alphabet to select the first letter of the program name to be used. Press the right arrow key to move to the second letter.

When program name is completed, pressing the enter key will reveal a prompt for 'Template. Using the numerical keypad and the shift key simultaneously enter the number of the template being used and press enter.

'Nozzle type No". Again using the numerical keypad and the shift key simultaneously enter the number that represents the nozzles being used and press enter.

To store information on whether the conveyor is jogging up and down in between each individual product, use the right arrow key to select 'ON' or 'OFF' when 'jog selector' is revealed.

To store information on whether a hard dough hopper or a soft dough hopper is being used, use the right arrow key to select 'HD' or 'SD' when 'H/S HOPPER' is revealed.

Upon entering the last line the program will automatically be saved with all its relevant information.

If an incorrect name, number or choice is made during the saving process, abort the saving of a new program at any time by pressing escape.



- **DELETE ITEM**

Enables selected product programs to be deleted from the product program directory. This operation is also password protected to avoid misuse and mistakes.

Select DELETE ITEM by using the up and down arrow keys, and then press enter.

*This will reveal the instruction 'Enter password'*

To enter the password use the numerical keypad while simultaneously pressing the SHIFT key.

*Upon entering the password a check screen, which allows the delete operation to be aborted, is then invoked.*

Press the appropriate left or right arrow key.

*A second check screen then ensures you have selected the correct product program to delete.*

Press the appropriate left or right arrow key to accept or prevent the procedure.

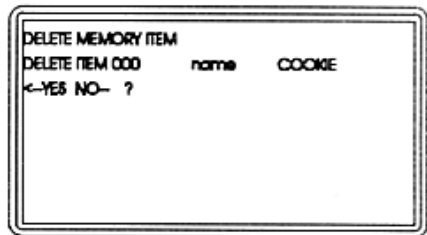
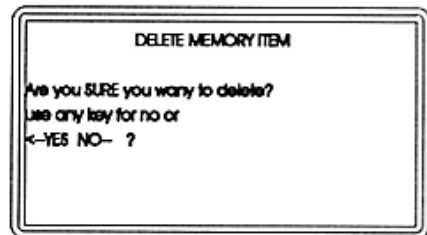

- **SORT**

Enables the list of product programs to be sorted into alphabetical order if so desired. Select SORT by using the up and down arrow keys and then pressing enter to reveal another screen offering the choice of either accepting or refusing the option. Press the appropriate left or right arrow key to accept or prevent the procedure.

- **DELETE DIRECTORY**

- 

**WARNING! This cannot be undone. WARNING!**

Enables the complete deletion of all product programs contained within the controller's memory. This function also allows the clearance of all corrupt data from the memory banks of the controller should this occur and could be an essential requirement in this event. Select DELETE DIRECTORY by using the up and down arrow keys, and then pressing enter. This will reveal the instruction 'Enter password'. To enter the password, use the numerical keypad while simultaneously pressing the SHIFT key. Upon entering the password a check screen, which allows the delete operation to be aborted, is then invoked. Press the appropriate left or right arrow key to accept or prevent the procedure.

**WARNING! This cannot be undone. WARNING!**

## 2. PRODUCT SELECT MENU

Upon switching on the machine, this menu is automatically appears.

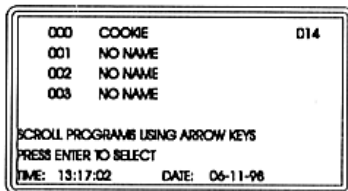

- **EXISTING PROGRAMS**

To select an existing program, use the up and down arrow keys to scroll through the product programs. Place the cursor over the required program; pressing enter will then recall the 'RUN MENU' with all the relevant information for this product program.

- **NEW DROP PRODUCTS**



To create a new drop product program, access directly into the relevant menu can be selected by pressing the 'DROP MENU' key.

- **NEW STRIP PRODUCTS**



To create a new strip product program, access directly to the relevant menu can be selected by pressing the 'STRIP MENU' key.

- **OTHER NEW PRODUCTS**

To create other more complicated product programs, access directly to the relevant menu can be selected by pressing the 'FUNCTION' key (Q) and then selecting the 'EDIT/CREATE' menu by using the up and down arrow keys.

### 3. RUN MENU

Enables the use of an existing product program without modification. Once made current, by selecting from the initial ' menu select menu', the ALPHA operates in either 'manual' or 'automatic' mode. Once the 'RUN MENU' screen is evoked it displays, as a visual reminder, all the pertinent information to instruct on machine, template and tray set-up.

RUN MENU	
PROGRAM	00 COOKIE
No. OF ROWS	000
TEMPLATE	00000 SD HOPPER
HEIGHT SET	000
SPEED	000
LOG SETUP	OFF
TIME: 13:17:02	DATE: 06-11-98

### 4. DELETE MENU

- **CLEAR COUNTER**

Selection of clear counter using the enter key will reset, to zero, the total number of deposits. The counter is visible on the bottom of the screen when the machine is running.

- **DELETE PRODUCT**

Selection of delete product will clear the product creation menus to enable a new program to be entered.

## C) **DIAGNOSTICS AND MACHINE SET- UP**

### 1. **SPEED SET UP MENU**

Enables default values for maximum speed of each of the **ALPHA'S** axes and acceleration values to be entered. In the absence of any other speed instruction, within the product program, the speed values entered within this menu will be used by the controller to produce machine movements.

From the 'RUN MENU' the 'SPEED SET UP MENU' is available by pressing the 'FUNCTION' key and then selecting using the up and down keys. This operation is password protected to avoid misuse and mistakes. Once the parameters contained within this menu have been **factory set** they should not need adjustment, however, they are user accessible.

Entry of the password will reveal the factory set figures as shown below: -

Speed deposit	=	120
Speed table	=	105
Speed rotary	=	200
Initial tray vel	=	35
Max acc lim	=	65
Jog down acc	=	25
Jog up acc	=	20

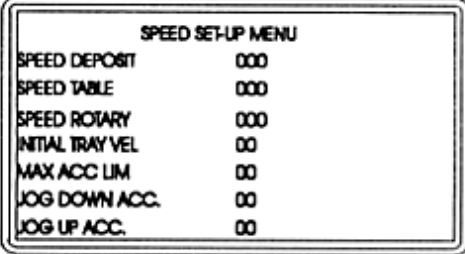

SPEED SET-UP MENU	
SPEED DEPOSIT	000
SPEED TABLE	000
SPEED ROTARY	000
INITIAL TRAY VEL	00
MAX ACC LIM	00
JOG DOWN ACC.	00
JOG UP ACC.	00

The parameters contained within the 'Speed set-up menu' have the following effect: -

- **DEPOSIT SPEED**

Sets the maximum linear speed value (up to a maximum preset value) for the forward direction of the Deposit pump axis (Axis 0). For the depositing of product mix to make products in the absence of an alternative value entered in a SPEED command in the product program.

- **TABLE SPEED**

Sets the maximum linear speed value (up to a maximum preset value) for the forward and reverse direction of tray conveyor axis (Axis 1) for the following conditions: -

- a) During product creation in either forward or reverse direction in the absence of an alternative value entered in a SPEED command line in the product program.
- b) Between the point of completion of one product and the start of the next.

- **ROTARY SPEED**

Sets the maximum linear speed value (up to a maximum preset value) for the forward direction of the rotary axis (axis 3). For the creation of a rotary product in the absence of an alternative value entered in a SPEED command in the product program.

- **INITIAL TRAY VELOCITY**

Sets the maximum linear speed value (up to a maximum preset value) for the forward movement of the tray conveyor axis (Axis 1), to progress the tray to the depositing position and the reverse movement to return the tray to the operator when operating in MANUAL mode.

- **MAXIMUM ACCELERATION LIMIT**

Sets the maximum acceleration rate (and deceleration) for movement in the forward direction of the deposit pump and forward/reverse movement of the tray conveyor. When changing speed either from rest up to the linear speed setting (accelerating) or when slowing down from maximum speed setting to rest (decelerating).

If more than one axis is moving simultaneously then similar rules governing acceleration as speed apply, i.e. the axis that has to accelerate at the fastest rate to achieve its demanded position will assume their programmed value. The other simultaneously moving axis will be automatically compensated such that all start and finish accelerating (or decelerating) simultaneously.

- **JOG DOWN ACCELERATION**

Sets the maximum acceleration rate (and deceleration) for the downward movement of the conveyor table during the jogging cycle in between each individual product.

- **JOG UP ACCELERATION**

Sets the maximum acceleration rate (and deceleration) for the upward movement of the conveyor table during the jogging cycle in between each individual product.

## 2. OFFSET MENU

- **SOFT DOUGH**

The distance, in millimetres, that the tray is progressed forward, beyond the point at which the tray is detected by the tray sensor to correctly position the tray underneath the soft dough hopper depositing centre line. Once progressed forward by the offset distance, the tray is in the correct position for use with the information entered under 'tray length'.

- **HARD DOUGH**

As above but for hard dough hopper.

## 3. SET UP AND DIAGNOSTICS

A number of controller based diagnostic functions exist on the **ALPHA** that allow controller and machine sensors and motors to be tested through use of the LCD screen and appropriate menus.

Also use is made of the LCD screen for each axis set up to display information pertinent to correct adjustment of the **ALPHA'S** amplifier cards.

Pressing of the FUNCTION key whilst in the 'RUN MENU' will allow selection of the DIAGNOSTICS menu, by means of the up and down arrow keys. This operation is password protected to avoid misuse and mistakes.

- **SET TIME**

Enables the user to alter the time display (24 hour clock), which appears on a number of screens. Select 'SET TIME' by means of the arrow keys. Input numerical values using the main keypad and the shift key and by following the on screen prompts.

HH = Hours (24 hour clock)

MM = Minutes

SS = Seconds

i.e. for 2:30 pm enter 14:30:00

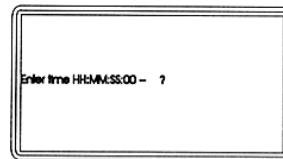

- **SET DATE**

Enables the user to alter the date display, which appears on a number of screens alongside the time display. Select 'SET DATE' by means of the arrow keys. Input numerical values using the main keypad and the shift key and by following the on screen prompts.

DD = Day date

MM = Month

YY = Year

i.e. for 6<sup>th</sup> September 2003 enter 06:09:03

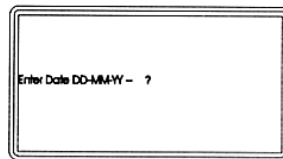

- **TEST DACS MENU**  
(digital to analogue converters)

Enables a controller hardware test.

**Only to be performed by, or on the instructions of MONO Equipment.**

**IMPORTANT:** - DISABLE THE MOTOR DRIVES USING THE EMERGENCY STOP BEFORE RUNNING THIS TEST

Select 'TEST DAC MENU' by means of the arrow keys. Enter numerical values as appropriate using the main keypad to select the expected test result from on screen options.

To measure the dac output and to determine whether each is functioning correctly place a voltmeter across its outputs and compare each output with the expected displayed value associated with each option.

*"Ramp drivers" is for use by the software developer only.*

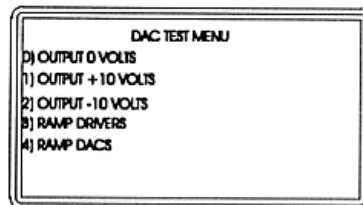

- **KEYPAD TEST**

Enables a check by the user that each button on the keypad is registering an output and therefore functioning.

Select 'KEYPAD TEST' by means of the arrow keys to reveal 'Press keys in sequence. To exit use same key twice'. Follow instructions and press any key to register a display on the LCD screen and provided the display changes each time a key is pressed then that key is functioning.

**A typical display is**

**Dec = 49 hex = \$31**

- **INPUTS TEST**

Enables readout from the LCD screen display as to the on/off status of all sensors, safety switches and power switches associated with the ALPHA giving, at a glance, confirmation of individual sensor failure or otherwise.

Correct functioning of any sensor/switch will indicate a change in the display each time it changes state (i.e. switches). Care must be taken to activate each sensor properly when determining whether it is functioning correctly, as failure to do so will lead to a false diagnosis.

Select 'INPUT TEST' by means of the arrow keys to reveal the display shown. Each input (sensor/switch) to the controller has an individual digital display associated with it indicating its status as either 0 (activated) or 1 (non activated). These status displays are shown on the middle line of the screen. The bottom line of the screen shows a hexadecimal equivalent of the binary readout of the second line.

The top line is an identification reference for each of the digits on the second line and placed directly above the second line.

Each sensor is associated with a digit in the second line.

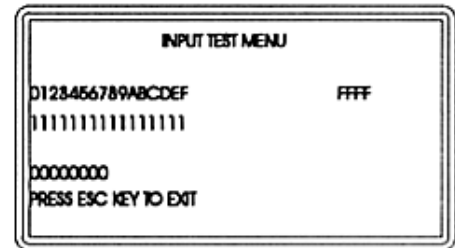

- **EXIT TO OPERATING SYSTEM**

Enables the reloading of new software to the controller from a suitable source using appropriate communication links. Select 'OPERATING SYSTEMS' by means of the arrow keys to reveal the display shown. This screen is at the highest level – one level above the ALPHA'S main menu.

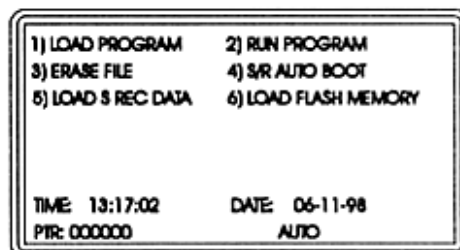



## • LOADING NEW PROGRAM

### Equipment required:

Interface lead (2 x 9-way D-type connector – one male, one female) approx 2M long.  
386 (min) PC c/w floppy disk drive  
9-way D-type serial port  
software- MS-DOS 4.1 or higher

### PROCEDURE

- a) At this point remove rear cover to controller pod of the ALPHA and plug in the interface lead into the 9-way D-type socket of the controller. Plug in the other end of interface cable to the 9-way serial port of the PC.
- b) Switch on the ALPHA and press the 'FUNCTION' key, select 'DIAGNOSTICS' option.
- c) Select 'Exit to OS' option.
- d) The keys relating to options 1-6 on the OPERATING SYSTEMS menu are not as the usual numerical keypad (see below). Choose option 'LOAD PROGRAM' (i.e. option A)

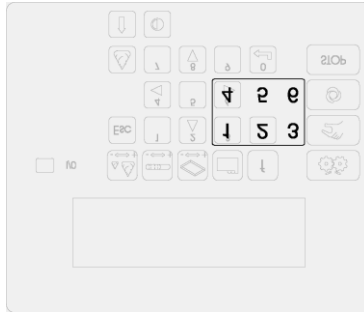

- e) Switch on PC and obtain c:\> prompt in DOS if loading from hard disk or a:\> if loading from floppy disk.
- f) Send program to the controller from the PC by entering 'send 1 <program name>'. At this point the message displayed on the screen will show the program loading onto controller and on completion will display a completed message.
- g) Press 'esc' key on the keypad to return to 'Op sys' menu.
- h) Press 6 to load the program into flash memory. The pointer (shown as Ptr) values will change to zero. (if unsuccessful at first attempt – retry)
- i) Press 4 until the message at the bottom of the screen changes from manual to auto.
- j) Press 2 to 'run program' and return to main menu.  
*Disconnect the 9-way D-type connector from the rear of the controller and replace rear cover of controller pod.*

**NOTE** - New software can be copied to agent/service engineers via E-MAIL /Modem communications.

## 4. INITIAL CHECKS

- a. Switch machine on at mains.
- b. Check all safety guards are closed and emergency stop button is released.
- c. With zero speed command and the drive disabled, apply power to the amplifier units by pressing start button – check that 3 status LED's are showing: -

**RED=OFF**

**YELLOW=ON**

**GREEN=OFF**

- d. Obtain `SPEED SET UP` menu and input the following values: -
  - Speed Deposit** : **120**
  - Speed Tray** : **105**
  - Speed Rotary** : **200**
  - Init. Tray Vel.** : **35**
  - Max Acc. Lim.** : **65**
  - Jog down Acc.** : **25**
  - Jog up Acc.** : **20**
- e. Obtain the password protected `SYSTEM SET UP` menu (see 1a and 1b). This automatically enables the amplifier units with a zero speed command signal. Input the following values: -
  - GAIN AXIS 0** : **250**
  - GAIN AXIS 1** : **240**
  - FILTER A 0** : **250**
  - FILTER A 1** : **250**
  - FILTER B 0** : **64**
  - FILTER B 1** : **128**
  - FERROR LIM** : **0**

Check there is no rapid acceleration of any of the motors, the motors shaft should remain stationary or drift slightly in either direction. If a runaway condition exists it is most likely a result of the motor armature leads being incorrectly connected. Check the 3 status LED's: -

**RED=OFF**

**YELLOW=ON**

**GREEN=ON**

- f. Still with zero speed command signal, adjust the offset pot until the MC (machine command signal) and the ENC (encoder counts) for the axis concerned are stable and at or near 0000 readout. These are displayed at the bottom of the screen.  
**Periodically re-check this setting throughout the following procedure.**
- g. In the motion control menu, adjust the offset potentiometer to give as smooth a command signal from the controller as possible
- h. Adjust the peak current pot accordingly.

AXIS 0 (Deposit Pump) - fully clockwise

AXIS 1 (Tray Conveyor) - 1/4 way clockwise

**All values once set should not need re-adjustment.**

## 5. FIELD SET UP

- Amplifier replacement

### Caution

Extreme care must be exercised when applying these procedures to machine mounted motors to avoid incurring damage to the machine, drive and/or motor. If at all possible the initial set-up should be performed with the motor decoupled from the machine and/or drive components.

To minimise the amount of setting-up required during commissioning or when replacing a drive on site the majority of the adjustments have been incorporated on a removable personality module. This means that when a drive is replaced on site it is simply necessary to take the personality module from the old drive and fit it on to the new drive. The only adjustments that remain to be done are the Offset. This is altered by means of a pot, the Offset pot being on the main pcb.

### AMPLIFIER UNIT

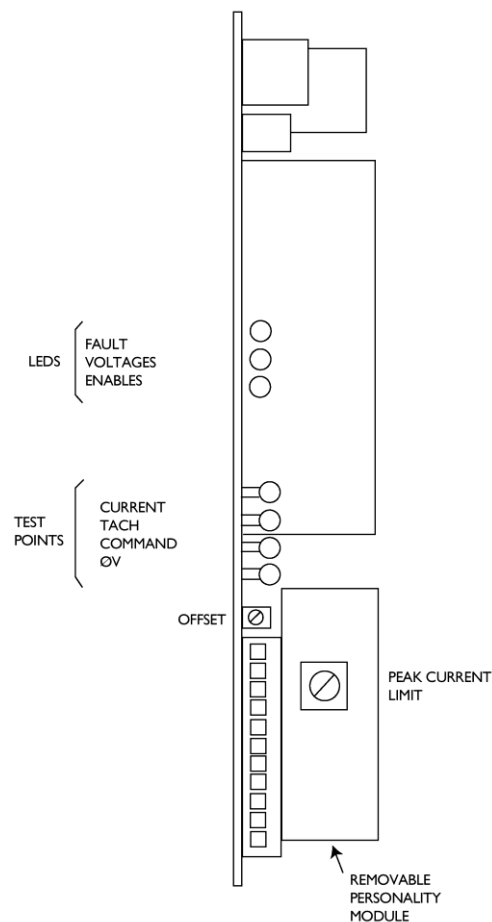

## INVERTER UNIT (ROTARY HEAD)

# KLOCKNER MOELLER OPTI DRIVE

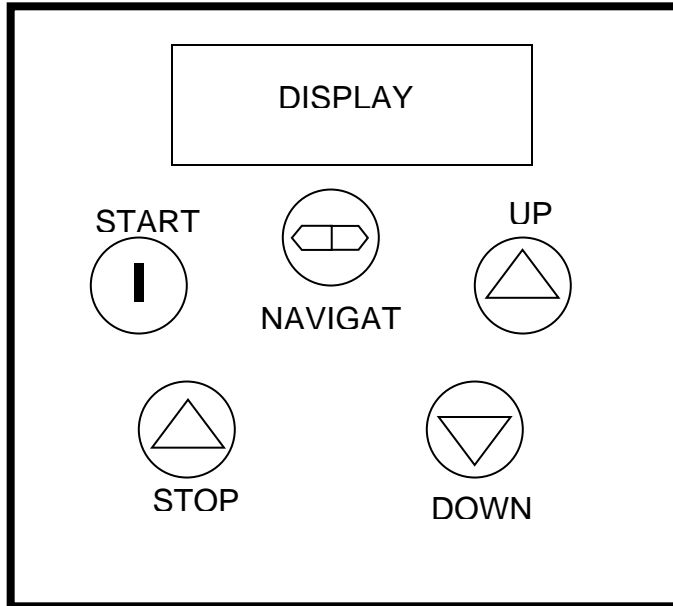

### TO ACCESS PARAMETERS FOR SETTING

1. Press **navigate** key for 1 second. *Display will indicate P-01*
2. Scroll through P-01 to P14 by pressing **up** or **down**
  - to display the parameter value press **navigate** key
  - to edit the parameter value use **up** and **down** keys.
  - to return to parameter number press **navigate** key.
  - to store a value and/or exit from edit mode press **navigate** button for more than 1 second or wait 20 seconds
  - to save all changes, switch off the power and wait for the screen to power down (blank screen) and switch back on.

### SETTINGS REQUIRED FOR MONO ALPHA

P-02	0 (0Hz)	MINIMUM SPEED
P-03	0.1s	ACCEL RAMP TIME
P-04	0.1s	DECEL RAMP TIME
P-08	2.1AMPS	MOTOR RATED CURRENT
P-32	1SEC	DC INJECTION BRAKING TIME

(TO ACCESS P-32, SET P-14 TO 101 AND PRESS NAVIGATE BUTTON)

- **INVERTER UNIT (ROTARY HEAD)**

## **IMO JAGUAR ONLY**

**Before replacing or connecting up the inverter the following has to be done.**

- 1: Remove link that is fitted between terminal FWD-CM.
- 2: Disconnect keypad potentiometer at CN2 connector; otherwise the inverter may be damaged.

- a) Switch off and **isolate machine from the mains supply.**
- b) Disconnect original inverter and replace and rewire new inverter.
- c) Switch on supply to machine and press the start button to energise the main contactor; the red LED display on the inverter will now be flashing.
- d) Five operating parameters need to be checked and altered.  
To select a function press the PRG/RESET button, the display will now indicate F00.  
The parameters that need checking are parameters F02, F03, F05, F06, F07 and F15. Use the UP/DOWN arrow keys to scroll through the parameters.  
When at F02, to view parameter-setting press FUNC/DATA button, this will display the present data value.  
To alter the value, press the UP/DOWN arrow buttons to scroll through the value setting. When at the value setting press the FUNC/DATA button to store the new value and go to the next function. Continue to check and if required change the functions  
F02 = 1, F03 = 50, F05 = 0.1, F06 = 0.1, F07 = 2 and F15 = 2.

**The inverter is now set up and can be run**

## 6. PASSWORD SETUP SCREEN (password required)

The ALPHA allows user editable password entry via a dedicated password menu (itself password protected).

To gain access to the password menu first gain access to the function screen and select 'Password'.

Upon entry of the password, the password menu is invoked, and the password codes for the following menus can be entered: -



Save product menu	*****
Delete product menu	*****
Default speed menu	*****
Password menu	*****
Diagnostics menu	*****

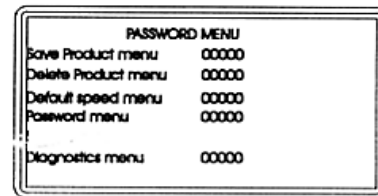

## 7. SCREEN WARNINGS

If when trying to run the machine, a warning message appears saying -

**“press start button”**

You must ensure the green start button is pressed and the hopper pour-thru guard is in place.

If when trying to run the machine, a warning message appears saying -

**“jog jammed see manual”**

Is there a tray jammed under the nozzles? Push down the table to release the tray.

Press the stop button and try manual again, machine should reset it's self.

If when escaping from a screen a warning appears saying -

**“program not saved”**

If escape is pressed again to return to program select menu all changes will be lost.

## CONVERSION FROM OPTIDRIVE TO ALTIVAR 11 INVERTER ON OMEGA AND ALPHA DEPOSITORS

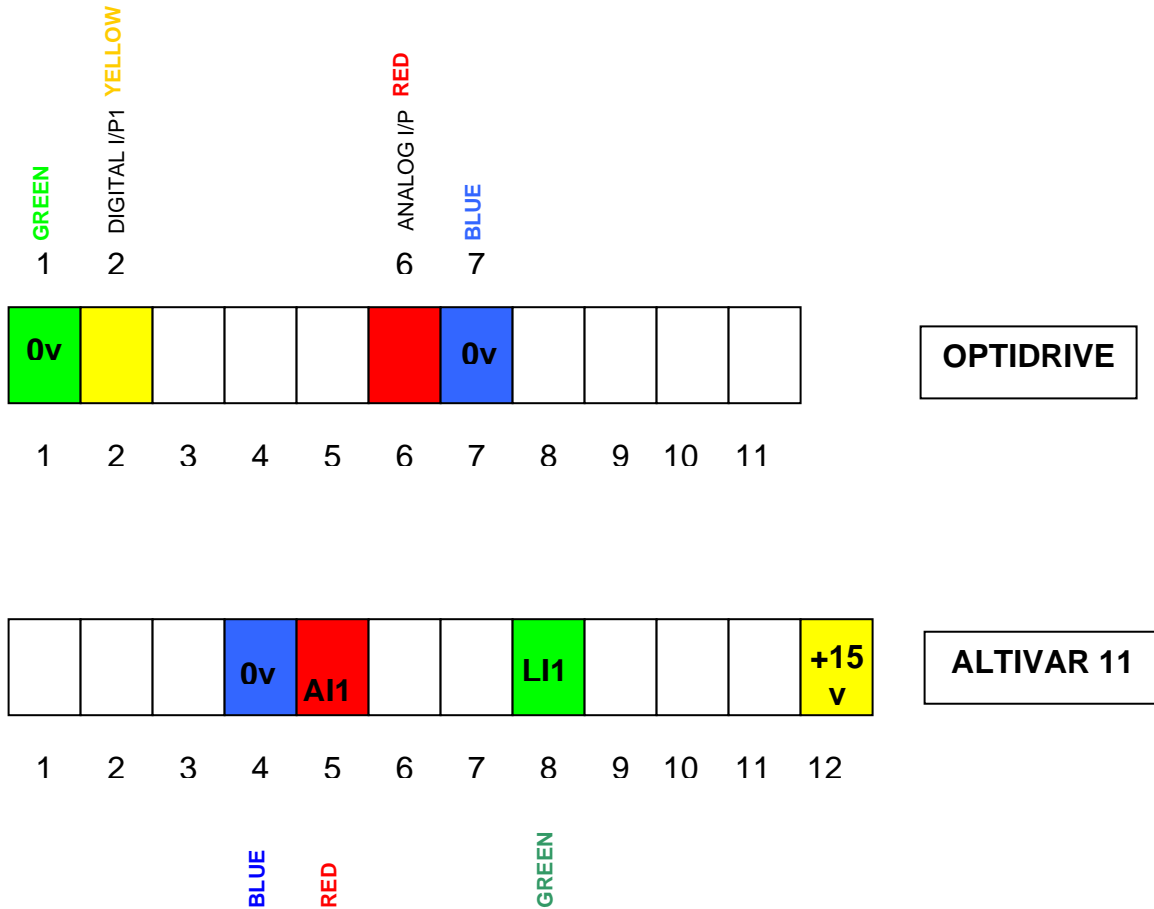

### ALTIVAR 11 SETTINGS

<b>bfr</b>	-	<b>50Hz</b>		
<b>Acc</b>	-	<b>0.1s</b>	-	<i>ACCEL RAMP TIME</i>
<b>dec</b>	-	<b>0.1s</b>	-	<i>DECEL RAMP TIME</i>
<b>LSP</b>	-	<b>0HZ</b>	-	<i>LOW SPEED</i>
<b>lth</b>	-	<b>2.1amp</b>		<i>MOTOR CURRENT</i>
<b>Alt</b>	-	<b>Act</b>	- <b>10v</b>	<i>ANALOG INPUT SCALE</i>
<b>drC</b>	-	<b>FLG</b>	- <b>95%</b>	<i>FREQUENCY LOOP GAIN</i>
<b>Fun</b>	-	<b>tcc</b>	- <b>Act- 2C</b>	<i>APPLICATION FUNCTION MENU</i>
		<b>tct</b>	- <b>Lel</b>	<i>TYPE OF CONTROL (2 WIRE)</i>
<b>Adc</b>	-	<b>Act</b>	- <b>YES</b>	<i>DC INJECTION</i>
		<b>tdc</b>	-	<i>1.0s – INJECTION TIME</i>

## Functions of the display and the keys

- Exits a menu or parameter, or aborts the displayed value to return to the previous value in the memory
- Returns to the previous menu or parameter, or increases the displayed value
- 3 "7-segment" displays
- Enters a menu or a parameter, or saves the displayed parameter or value
- Goes to the next menu or parameter, or decreases the displayed value



Pressing ▲ or ▼ does not store the selection.

Save the selection :

Example:

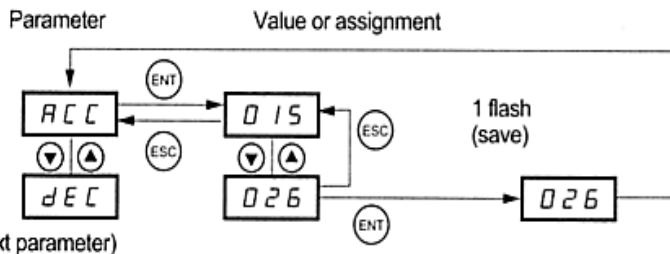

The display flashes when a value is stored.

Normal display, with no fault present and no startup:

- rdY: Drive ready
- 43.0: Display of the parameter selected in the SUP menu (default selection: frequency reference).
- dcb: DC injection braking in progress
- nSt: Freewheel stop

If there is a fault, it is shown with a flashing display.





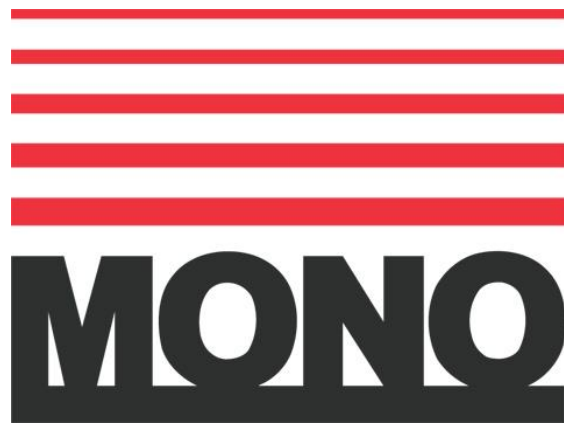

## **MONO Equipment**

Queensway Swansea Industrial Estate Swansea SA5 4EB UK

Tel. 01792 561234 Fax. 01792 561016

*As it is our policy to improve our machines continuously, we reserve the right to change specifications without prior notice.*