

Enter **Serial No.** here. \_\_\_\_\_

In the event of an enquiry please quote this serial number.



# OPERATING AND MAINTENANCE MANUAL

## HAND-FEED MULTI-MOULDER

### FG105



## DECLARATION OF CONFORMITY

We hereby declare that this machine complies with the essential health and safety requirements of :-

- The Machinery Directive 2006 / 42 / EC
- The Low voltage Directive 2006 / 95 / EC
- The requirements of the Electromagnetic Compatibility Directive 2004 / 108EC, 91 / 263 / EEC, 92 / 31 / EEC
- The General Safety of Machinery and food processing Standards applicable
- Materials and Articles intended to come into contact with food - Regulation (EC) No. 1935 / 2004
- Good manufacturing practice for Materials intended to come into contact with food - Regulation (EC) No. 2023 / 2006

<b>Signed</b>	
<b>D. Osmundsen – Quality and Conformance Manager</b>	

<b>Date</b>	
-------------	--

<b>Machine FG Code.</b>		<b>Machine Serial No.</b>	
-----------------------------	--	-------------------------------	--

A technical construction file for this machine is retained at the following address:

**MONO EQUIPMENT**  
Queensway,  
Swansea West Industrial Park,  
Swansea  
SA5 4EB  
UK

**MONO EQUIPMENT** is a business name of **AFE GROUP Ltd**  
Registered in England No.3872673 VAT registration No.923428136

Registered office: Unit 35,  
Bryggen Road,  
North Lynn Industrial Estate,  
Kings Lynn Norfolk,  
PE30 2HZ



## ELECTRICAL SAFETY AND ADVICE REGARDING SUPPLEMENTARY ELECTRICAL PROTECTION

Commercial kitchens and food service areas are environments where electrical appliances may be located close to liquids or operate in and around damp conditions or where the restricted movement for installation and service is evident.

The installation and periodic inspection of the appliance should only be undertaken by a qualified, skilled and competent electrician, and connected to the correct power supply suitable for the load as stipulated by the appliance data label.

The electrical installation and connections should meet the necessary requirements of the local electrical wiring regulations and any safety guidelines.

### We recommend:-

- Supplementary electrical protection with the use of a Residual Current Device (RCD)
- Fixed wiring appliances should also incorporate a locally situated switch disconnector to connect to, which is easily accessible for switching off and safe isolation purposes. The switch disconnector must meet the specification requirements of IEC 60947.

### Your attention is drawn to:-

#### **BS 7671:2018 – Guidance Note 8 – 8.13: Other locations of increased safety risk**

It is recognised that there may be locations of increased risk of electrical shock other than those specifically addressed in Part 7 of BS 7671. Examples of such locations could include laundries where there are washing and drying machines in close proximity and water is present, and commercial kitchens with stainless steel units, where once again, water is present. Where, because of the perception of additional risks being likely, the installation designer decides that an installation or location warrants further protective measures, the options available includes:

- Automatic Disconnection of Supply (ADS) by means of a residual current device having a residual operating current not exceeding 30 mA;
- Supplementary protective equipotential bonding; and
- Reduction of maximum fault clearance time.

The provision of RCDs and supplementary bonding must be specified by the host organisation's appointed installation designer or electrical contractor and installed by a suitably qualified and competent electrician so as to comply with Regulations 419.2 and 544.2.



The supply to this machine must be protected by a **30mA-rated Type A RCD**

# SAFETY SYMBOLS

The following safety symbols are used throughout this product documentation and manual (available at [www.monoequip.com](http://www.monoequip.com)).

Before using your new equipment, read the instruction manual carefully and pay special attention to information marked with the following symbols



## **WARNING**

Indicates a hazardous situation which, if not avoided, will result in death or serious injury.



## **WARNING**

Indicates a hazardous situation which, if not avoided, will result in electric shock.



## **CAUTION**

Indicates a hazardous situation which, if not avoided, will result in minor or moderate injury.



The supply to this machine must be protected by a **30mA-rated Type A RCD**

**ENSURE THE MOULDER IS SET UP AND ADEQUATE TINS AND TRAYS ARE AVAILABLE BEFORE STARTING.**

**FAILURE TO ADHERE TO THE CLEANING AND MAINTENANCE INSTRUCTIONS DETAILED IN THIS BOOKLET COULD AFFECT THE WARRANTY OF THIS MACHINE.**

# CONTENTS

---

<b>Section - 1.0</b>	<b>Introduction</b>
<b>Section - 2.0</b>	<b>Overall Dimensions</b>
<b>Section - 3.0</b>	<b>Specifications</b>
<b>Section - 4.0</b>	<b>Safety</b>
<b>Section - 5.0</b>	<b>Installation</b>
<b>Section - 6.0</b>	<b>Isolation</b>
<b>Section - 7.0</b>	<b>Cleaning</b> <ul style="list-style-type: none"><li>○ Daily</li><li>○ Weekly</li></ul>

---

<b>Section - 8.0</b>	<b>Operating Information</b>
<b>Section - 9.0</b>	<b>Operating Machine</b> <ul style="list-style-type: none"><li><b>Hand-feed hopper gap setting</b></li><li>○ Moulding between belts (French stick and petit pan)</li><li>○ Moulding Between Rear Belt &amp; Pressure Board (Tin and Bloomers)</li></ul>

---

<b>Section - 10.0</b>	<b>Maintenance</b>
<b>Section - 11.0</b>	<b>Troubleshooting</b>
<b>Section - 12.0</b>	<b>Service and Spares</b>
<b>Section - 13.0</b>	<b>Electrical Information</b>

# 1.0 INTRODUCTION

---

**MONO's 105 Moulder** combines the capabilities of traditional bread and French stick moulding machines. Its small footprint and simple controls are of particular benefit in small bakeries. The 105 Moulder will process up to 900 dough pieces an hour.

# 2.0 OVERALL DIMENSIONS

---

**Height:** 1825mm.  
**Depth:** 1205mm.  
**Width:** 1020mm.

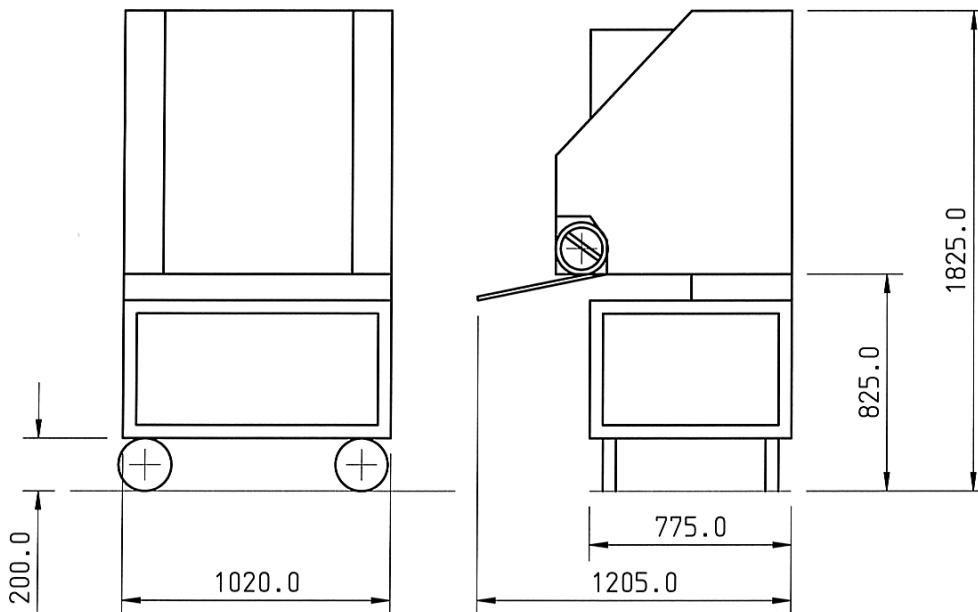

## 3.0 SPECIFICATIONS

---



The supply to this machine must be protected by a **30mA-rated Type A RCD**

**Total power:** 0.75kW three phase

**Capacity:** Up to 900 dough pieces processed every hour, between 250g (9oz) and 0.9kg (2lb) in weight and between 125mm (5") and 760mm (30")

**Weight:** 430kg

**Noise level:** **Less than 85dB.**

## 4.0 SAFETY



- 1 Never use a machine in a faulty condition and always report damage.
- 2 No one under 16 may operate this machine.
- 3 No one under 18 may clean this machine.
- 4 Only trained and authorised persons may remove any part that requires a tool to do so.
-  5 Always ensure hands are dry before touching any electrical appliance (including cable and plug).
- 6 All operatives must be fully trained.
- 7 People undergoing training on the machine must be under direct supervision of a trainer.
- 8 Do not operate with any panels removed.
- 9 All guards must be fixed in place with bolts or screws unless protected by a safety switch.
- 10 No loose clothing or jewellery to be worn while operating the machine.
- 11 Switch off power at the mains isolate switch or isolate at the main control box
- 12 The Bakery Manager or the bakery Supervisor must carry out daily safety checks.



**13 Warning: Do not attempt to scrape moulding belts when moulder is running.**

14 Any internal maintenance must be by fully trained maintenance personnel.



**WARNING:** Hand or bodily contact with moving belt surfaces may cause friction burns to skin.  
This situation need not occur to successfully operate moulder



## 5.0 INSTALLATION

---

- 1 Ensure machine is standing on a solid level floor. Lock the two front castors into place.



- 2 Check machine after installation to ensure drive motor rotation is in the direction of arrow. This should be done with drive V-belt removed. If motor rotation is incorrect, change round any two of the three phase carrying wires. Drive motor should be travelling in an anti-clockwise direction.

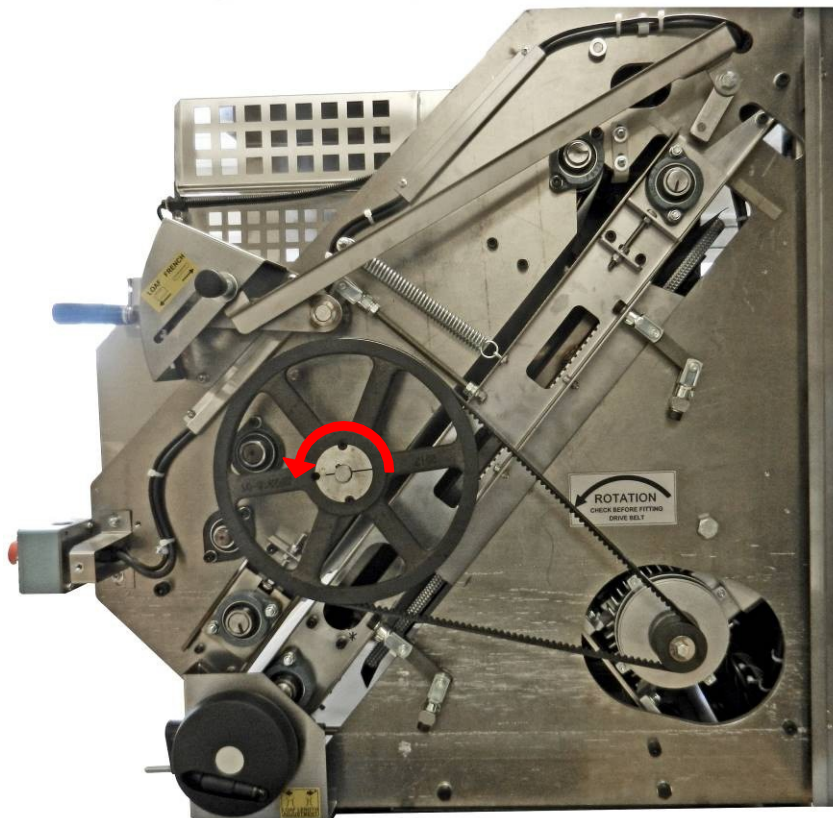

## 6.0 ISOLATION

---

To stop the moulder in an emergency,  
switch off at the main isolator,  
or use the emergency stop button on the front of the machine

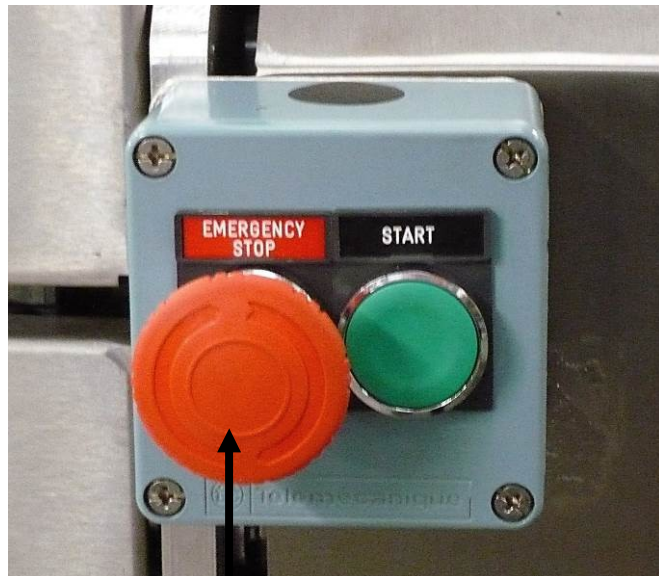

**EMERGENCY STOP BUTTON**  
(TWIST TO RELEASE)

## 7.0 CLEANING

---

### DAILY CLEANING INSTRUCTIONS

**NOTE!** - USE PLASTIC SCRAPERS TO REMOVE SUBSTANTIAL DOUGH PIECES PRIOR TO CLEANING.

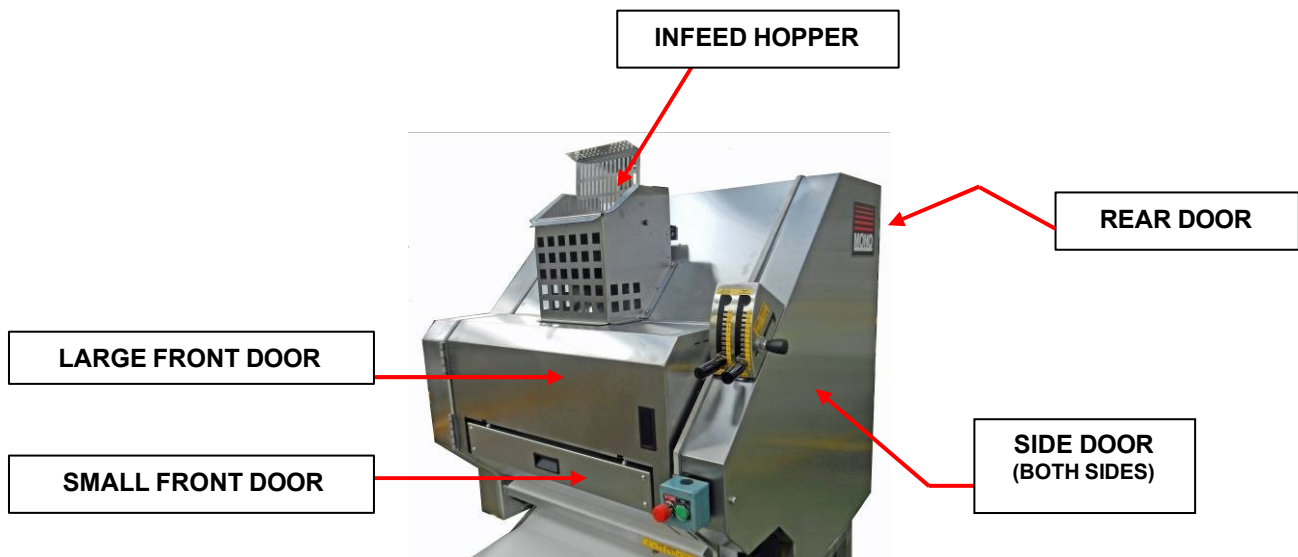

1. Isolate the mains supply.
2. Brush infeed hopper area.

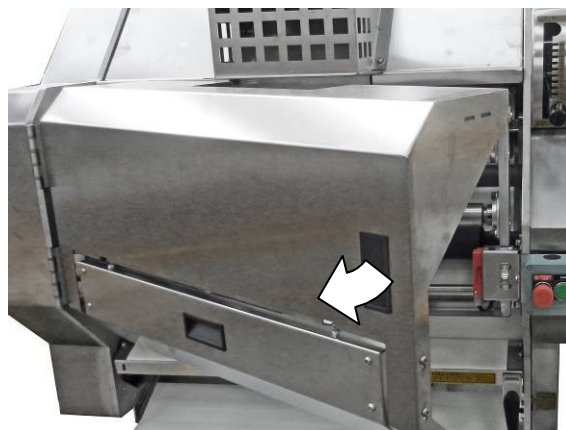

3. Open large hopper area door to expose rollers.

**SET SHEETING GAP**



4. Set sheeting gap to the widest mark and brush out residue from the area, using a plastic scrapper on the rollers if required.
  
5. Clean any residue that has been trapped at the bottom of the belt.  
Scrape exposed surface of the dough-moulding belt with **plastic** scraper.
  
6. Close cover and then remove bottom cover by lifting up slightly and lowering down.
  
7. Brush/vacuum the area and close cover.

# SCRAPER AND CURLING CHAIN REMOVAL

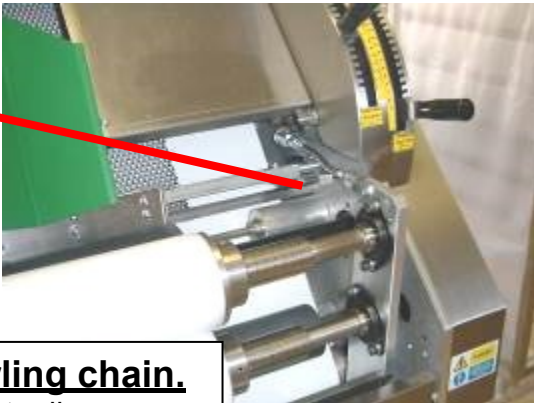

**To remove scraper and curling chain.**  
Slide clips sideways and lift up bar to disengage  
(one each side).



CLIP CLOSED

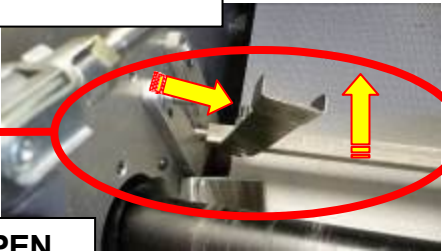

CLIP OPEN

**Detach top of curling chain**  
Lift chain off top bar and remove curling chain and scraper.



REAR VIEW

## To replace scraper and curling chain.

Clean and then replace the curling chain by dropping down conveyor from the back and clipping in place at the front. (Reverse of removal).

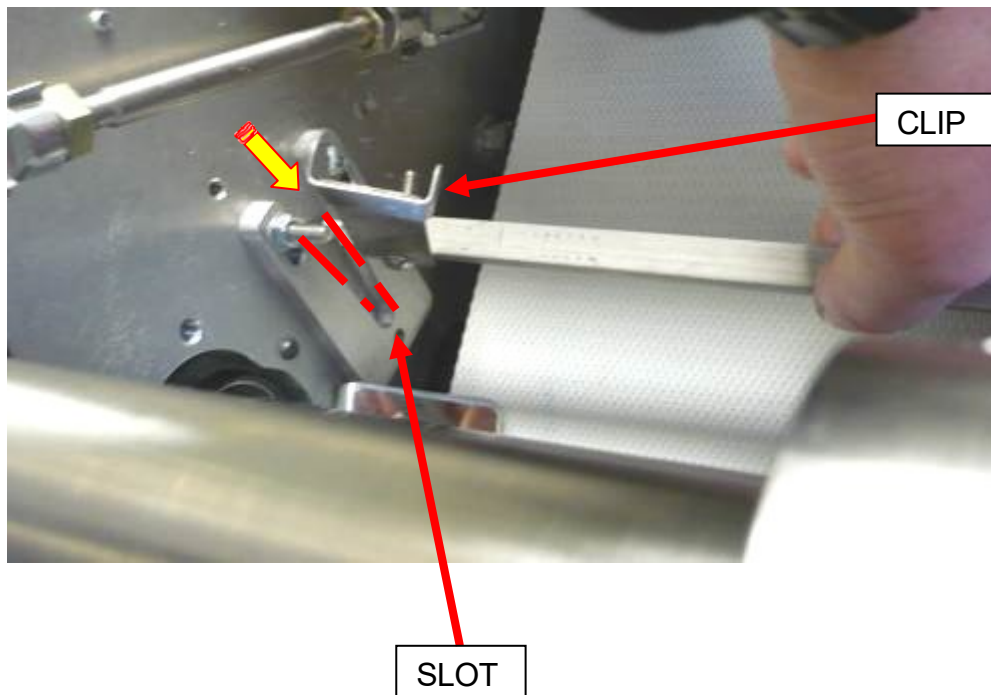

## Pressure Board Removal

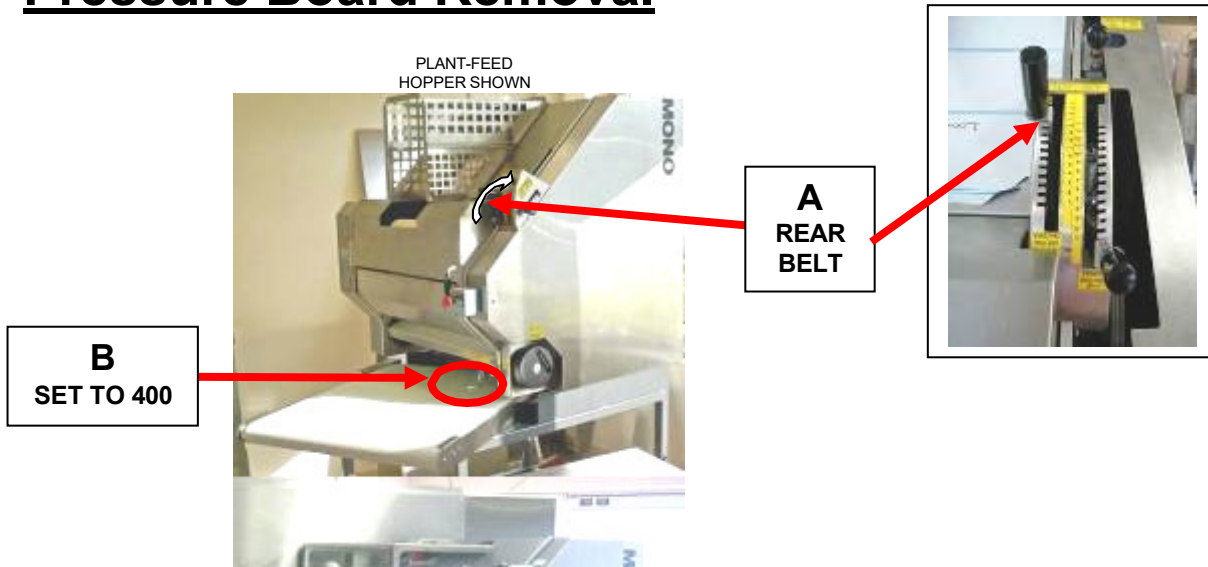

1. Fully lower the rear-moulding belt using lever (A) and fully lower the pressure board by adjusting handle (B) to setting “400” on the counter. Open rear door.
2. Remove the pressure board by gripping the handle provided, and then lift up and out.

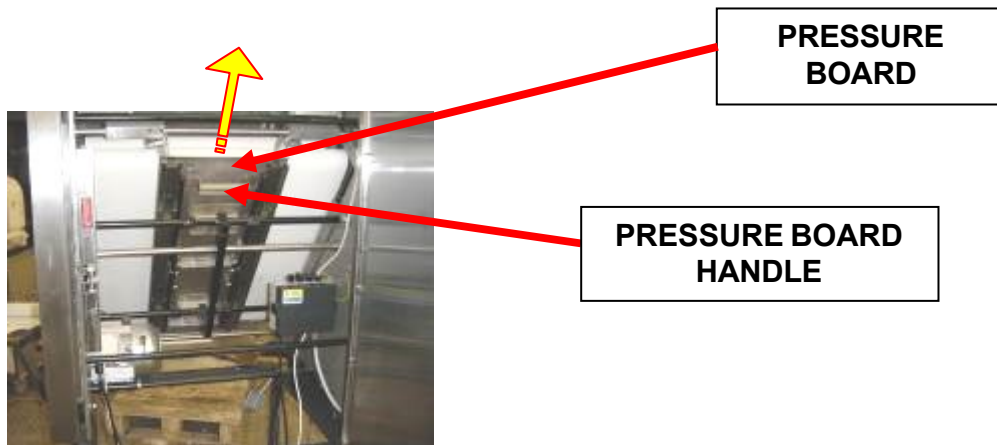

3. Wash dough contact surfaces of the pressure board and side guides with sanitising solution and hot water. Dry with cloth.
4. Remove any dough from the bottom belt with a plastic scraper.
5. Replace the pressure board, making sure the hooks on the board are fully engaged.

**Close the rear door firmly to make the safety switch connection.**

## OFF TAKE TRAY

This should be scraped clean with a plastic scraper.



OFF TAKE TRAY

- Brush down all external surfaces of the machine including the stand.
- Sweep under machine to remove all debris from the floor.
- Spot clean with cloth dampened, disinfecting solution and hot water, paying particular attention to handles, levers and controls.



# WEEKLY CLEANING INSTRUCTIONS

AS DAILY INSTRUCTIONS AND ALSO:



1. Disconnect power (mains plug).
2. Pull machine away from obstructions.
3. Wipe the stand with a cloth dampened with disinfecting solution and hot water.
4. Scrape and scrub the wheels on the machine.
5. Wipe down all internal surfaces with disinfecting solution and hot water.  
Dry with a cloth.

## 8.0 OPERATING INFORMATION

---

- 1 The Moulder should be used on a level floor for the best results.
- 2 All control levers, handles, etc are best adjusted when moulder is running, although they can be adjusted with the machine stationary.

### Machine cycle information.

- 1 The moulding elements consist of two dough guides, two differential sheeting rollers, a guide roller, a stripper roller, a removable curling chain, two endless polyurethane belts rotating in the same direction, a two position deflector, a pressure board, a pair of dough guides and an offtake tray.
- 2 Dough is delivered from the prover conveyor. The dough is then sheeted through the two differential rollers into a pancake shape.
- 3 The dough piece is taken off the rollers by means of a stripper roller and guided by the remaining roller onto the endless polyurethane belt. Upon making contact with the belt the dough piece is immediately pressurised by the curling chain mat. The light pressure produced by the chain causes the dough piece to roll over on its self and produce a sausage shape.
- 4 At this stage in the moulding process the dough path can be selected, via pushrod to be further processed either between front and rear belts or between the rear belt and pressure board.
- 5 Both of the moulding routes chosen will deposit the finished dough piece onto an offtake tray.

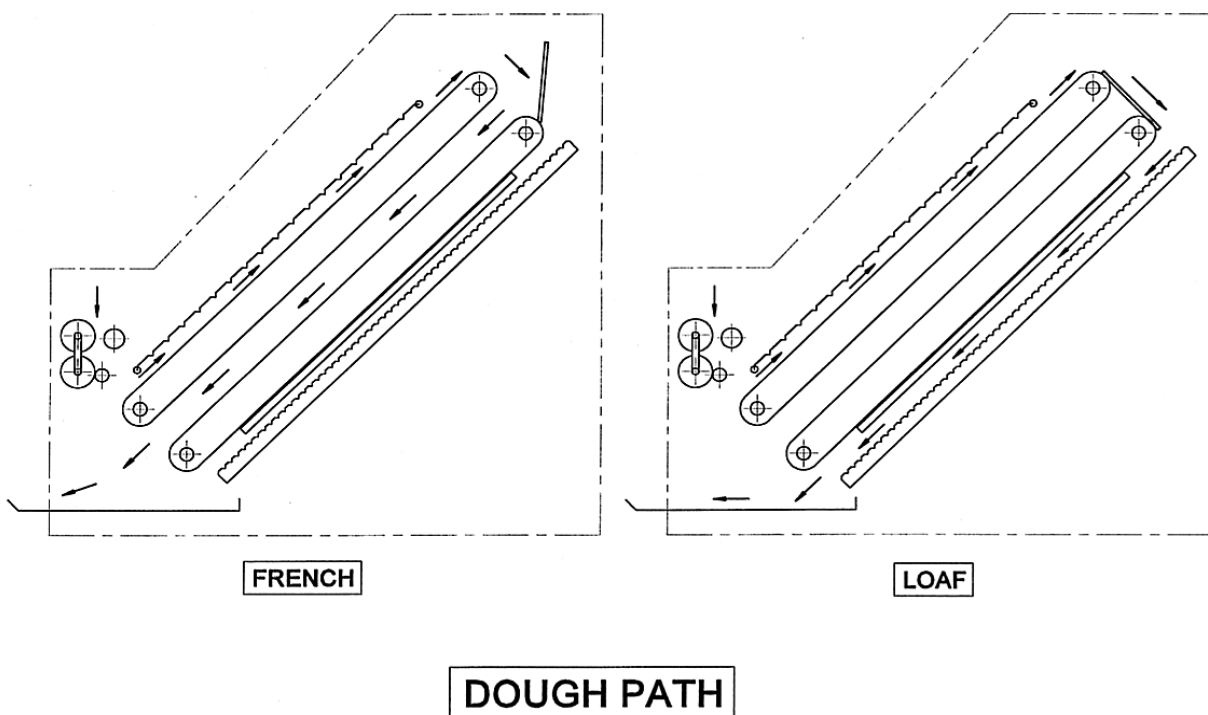

# 9.0 OPERATING INSTRUCTIONS

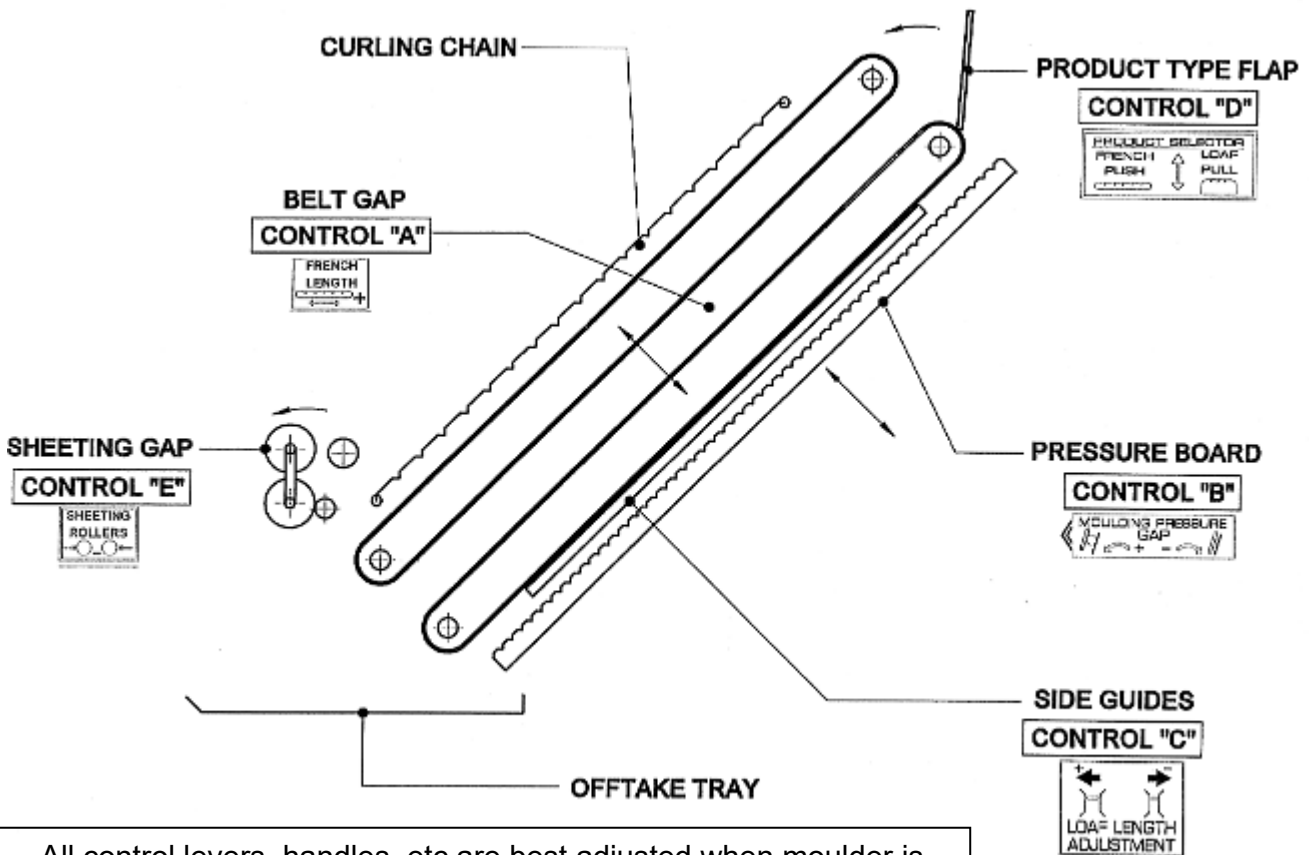
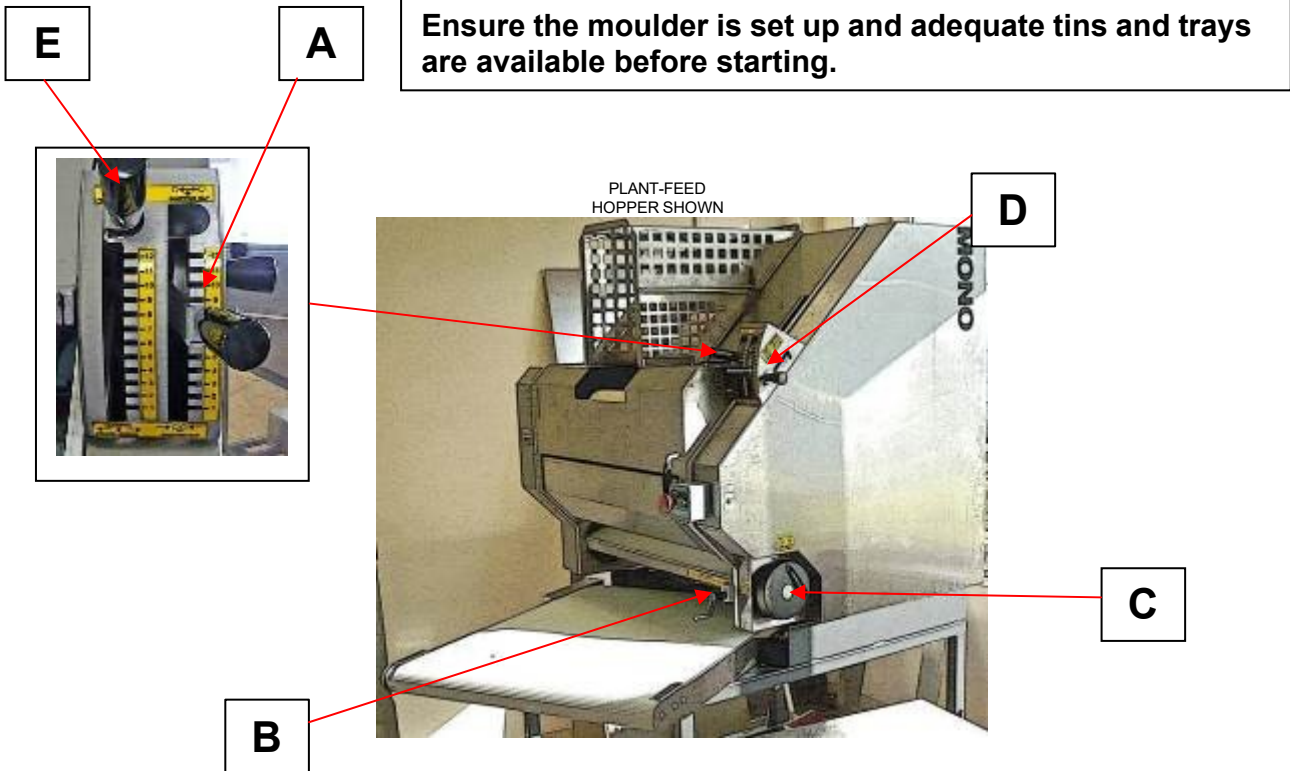

All control levers, handles, etc are best adjusted when moulder is running, although they can be adjusted with the machine stationary.

## HAND-FEED HOPPER GAP SETTING

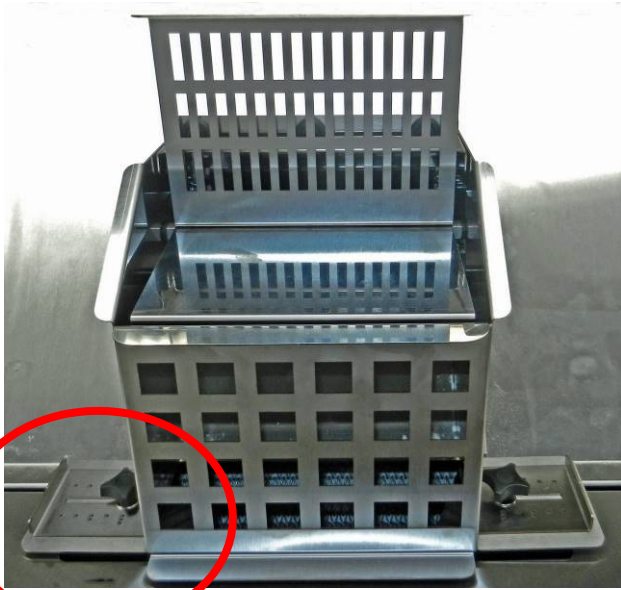

The hopper in-feed gap can be adjusted for large or small pieces. By decreasing the gap, smaller weight dough can be kept central on the moulding rollers.



Loosen knobs and slide the adjusting plates to the required position. Tighten knob. Ensure both sides are adjusted equally.

# MOULDING BETWEEN BELTS FRENCH STICK AND PETIT PAIN PRODUCTS.

Push lever "D" to position required (FRENCH)

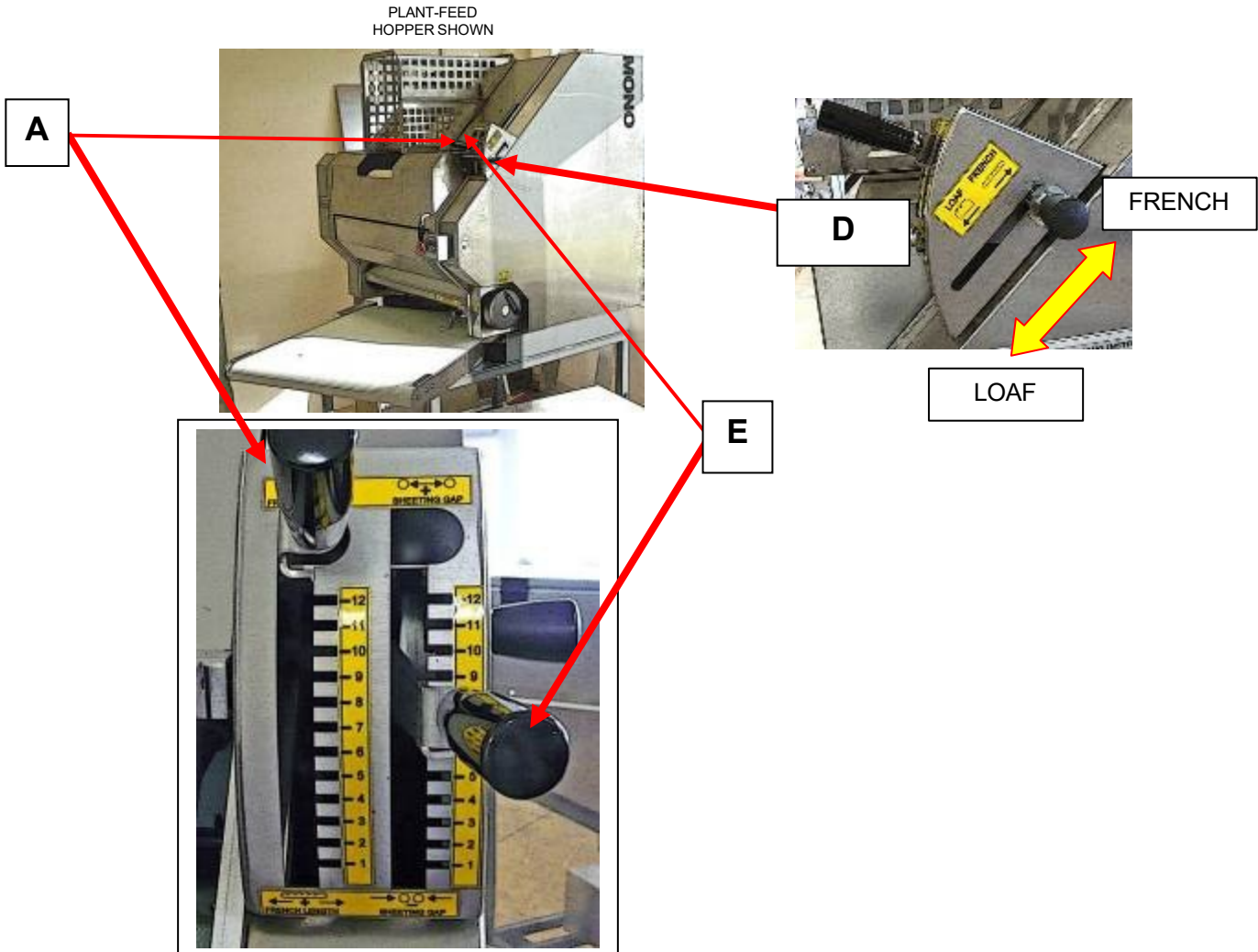

- 1 Set lever "A" to control the length of the dough piece required.
- 2 Adjust "E" to open or close the sheeting gap of the two infeed rollers.
  - Control settings will vary according to user, dough mixes, product, machine construction etc, and are best established by the user.
  - It is advisable for the Bakery Manager to inform staff of settings required for all French range once established. This will result in consistent product, assuming dough condition is constant.

# MOULDING BETWEEN REAR BELT AND PRESSURE BOARD TIN BREAD & BLOOMERS.

Push lever "D" to position required (LOAF)

- 1 **Position control lever "A" to position 0** – *this ensures the correct transfer of the dough piece after curling and correct discharge onto the return conveyor.*

- 1 **Adjust handle "E"** for the infeed sheeting gap.

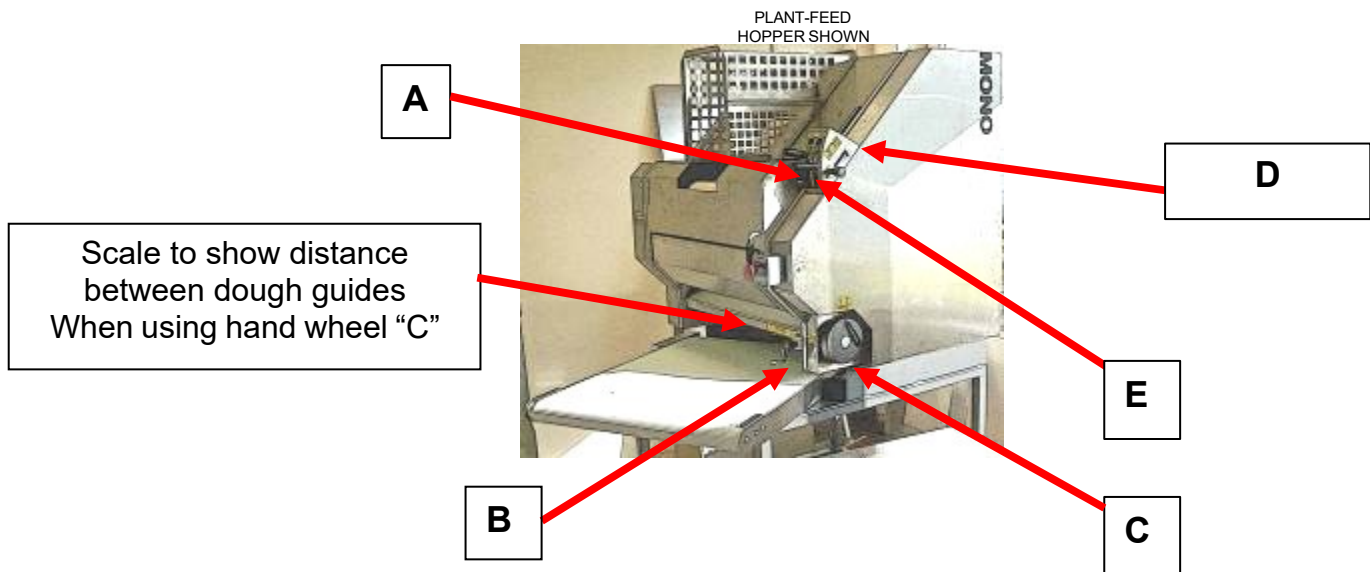

- 2 **Adjust handle "B"** for the pressure board.  
*Anti-clockwise will mean the numbers on the digital counter will increase and therefore the pressure on the dough will decrease. Clockwise will be the opposite. The number on the digital counter should be noted so it can be reproduced at a later date.*

- 4 **Adjust hand wheel "C"** to control the length of the loaf.  
*Hand wheel simultaneously positions the dough side guides equally about the centreline of the moulder. The distance between the dough guides is indicated by the metal pointer and the scale*

- 5 After moulding, the dough piece should be transferred from the offtake to a waiting tray.

## 10.0 MAINTENANCE

---

- 1 Refer to cleaning instructions.
- 2 Maintenance other than cleaning must be carried out by trained maintenance personnel.
- 3 It is recommended that the bearings, chain, motor, etc. be greased every six months
- 4 If a belt is tracking to the left or the right. Call in maintenance contractor immediately before any permanent damage can occur.

### MAINTENANCE ENGINEER NOTES

Moulding belts should be no tighter than necessary to eliminate slippage. Over tensioning can lead to belt and/or bearing failure. The belt should be adjusted by means of the adjustment tensioning screws (shown below).

The belts should run with equal clearance between its edges and the unit side frames. If one edge of the belt is tighter than the other, it will tend to run towards the slack side. This tracking defect can be eliminated by individual adjustment of the tensioning screws.

#### Caution

Adjustment screws should not be continually tightened (this will cause bearing failure or the moulding belt to stretch and break). It may be that one side is too tight so should be eased off a little.

Bearings and bearing grub screws (2 per bearing) should also be checked as a seized bearing may be the cause of the moulding belt needing adjustment.

If a bearing is replaced, the grub screws should be tightened and liquid thread lock applied. (On later models the grub screws should also be aligned with dimples in the roller shaft).

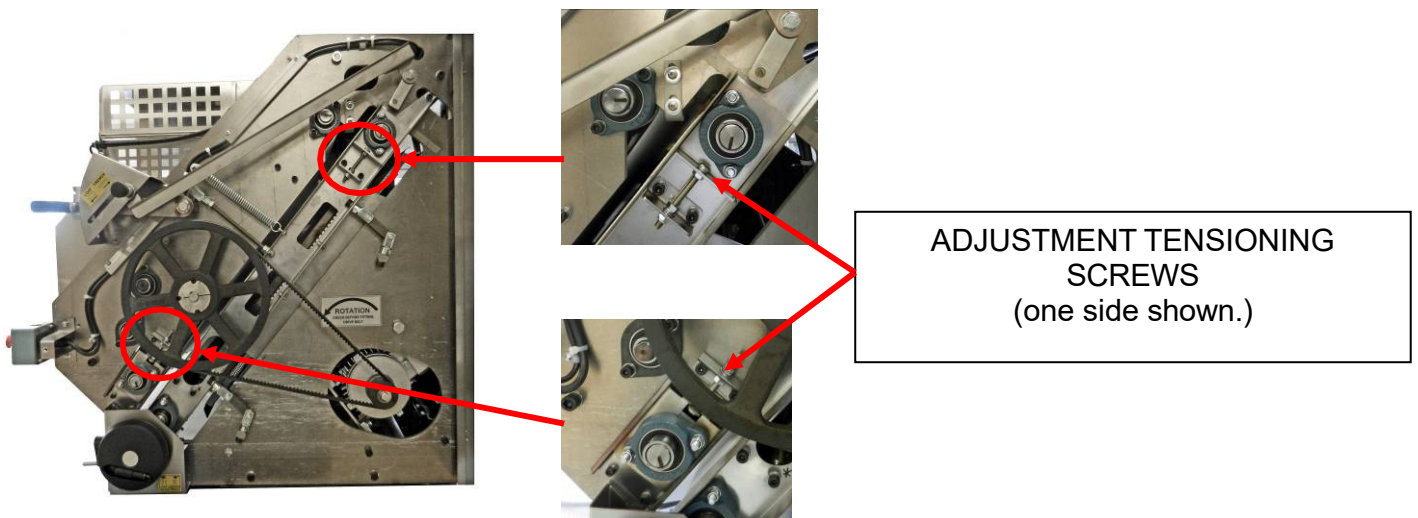

**WARNING**

- This appliance must be maintained at regular intervals. The frequency of maintenance will depend upon your specific use and location. The maximum service interval should be 12 months.
  - Service and maintenance should only be undertaken by suitably qualified, trained, and competent engineers.
  - You must immediately report any damage or defect arising with the appliance.
  - Unsafe equipment is dangerous. Do not use the appliance. Isolate the power supply and contact MONO or your appointed service agent.
-



## 11.0 TROUBLESHOOTING ---

- The final dough temperature, after mixing, should not exceed the ideal. (typically 25 - 26 ° C).
- A dough conditioner containing a good relaxant is required.
- French dough should be soft but not sticky.
- Curling chain should be kept clean.

## 12.0 SERVICE AND SPARES ---

If a fault arises, please do not hesitate to contact the Customer Service Department, quoting the **machine serial number** on the silver information plate of the machine and on the front cover of this manual

**MONO**  
Queensway  
Swansea West Industrial Estate  
Swansea.  
SA5 4EB  
UK

**email: [spares@monoequip.com](mailto:spares@monoequip.com)**  
**Web site: [www.monoequip.com](http://www.monoequip.com)**

**Spares Tel. +44(0)1792 564039**  
**Main Tel. +44(0)1792 561234**

# “V” BELT AND DRIVE INFORMATION

DUE TO CONTINUAL IMPROVEMENTS  
METALWORK MAY BE SLIGHTLY  
DIFFERENT ON THE MODEL YOU HAVE

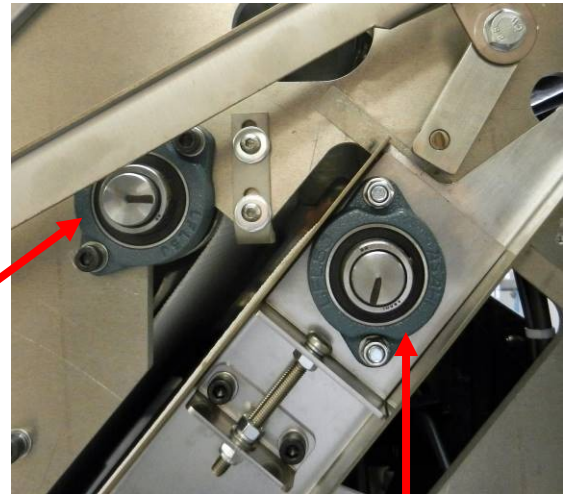

A900-09-108  
Main Pulley

A900-06-259  
Bearing

A900-06-259  
Bearing

A900-06-242  
Bearing

A900-09-105  
Motor drive Pulley

A900-06-227  
Bearing

A900-06-259  
Bearing

A900-21-109  
Main drive V belt

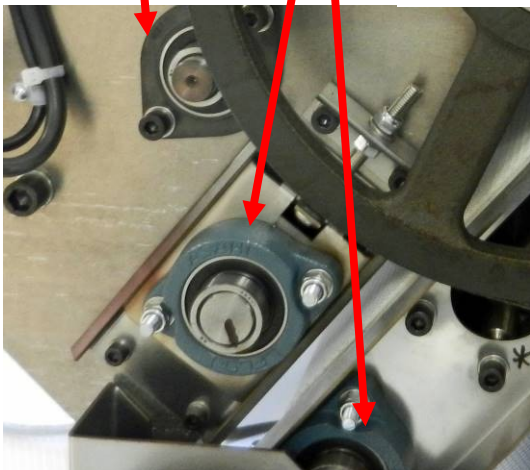
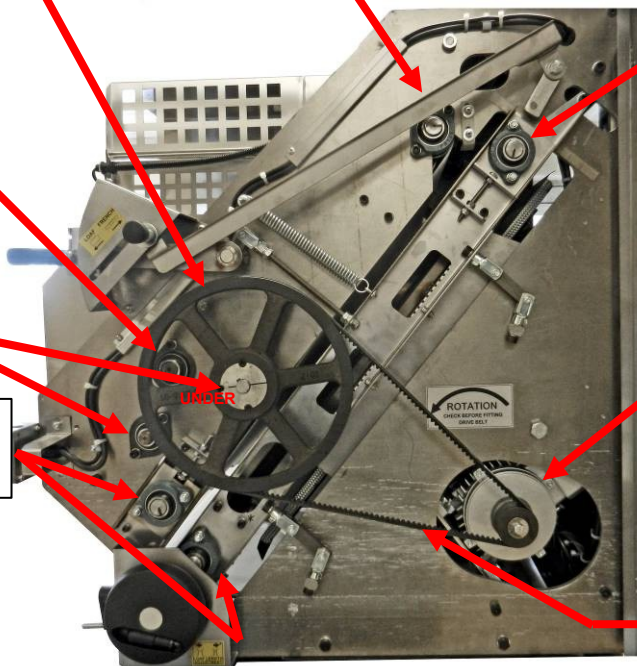

# MOULDING BELT DRIVE INFORMATION

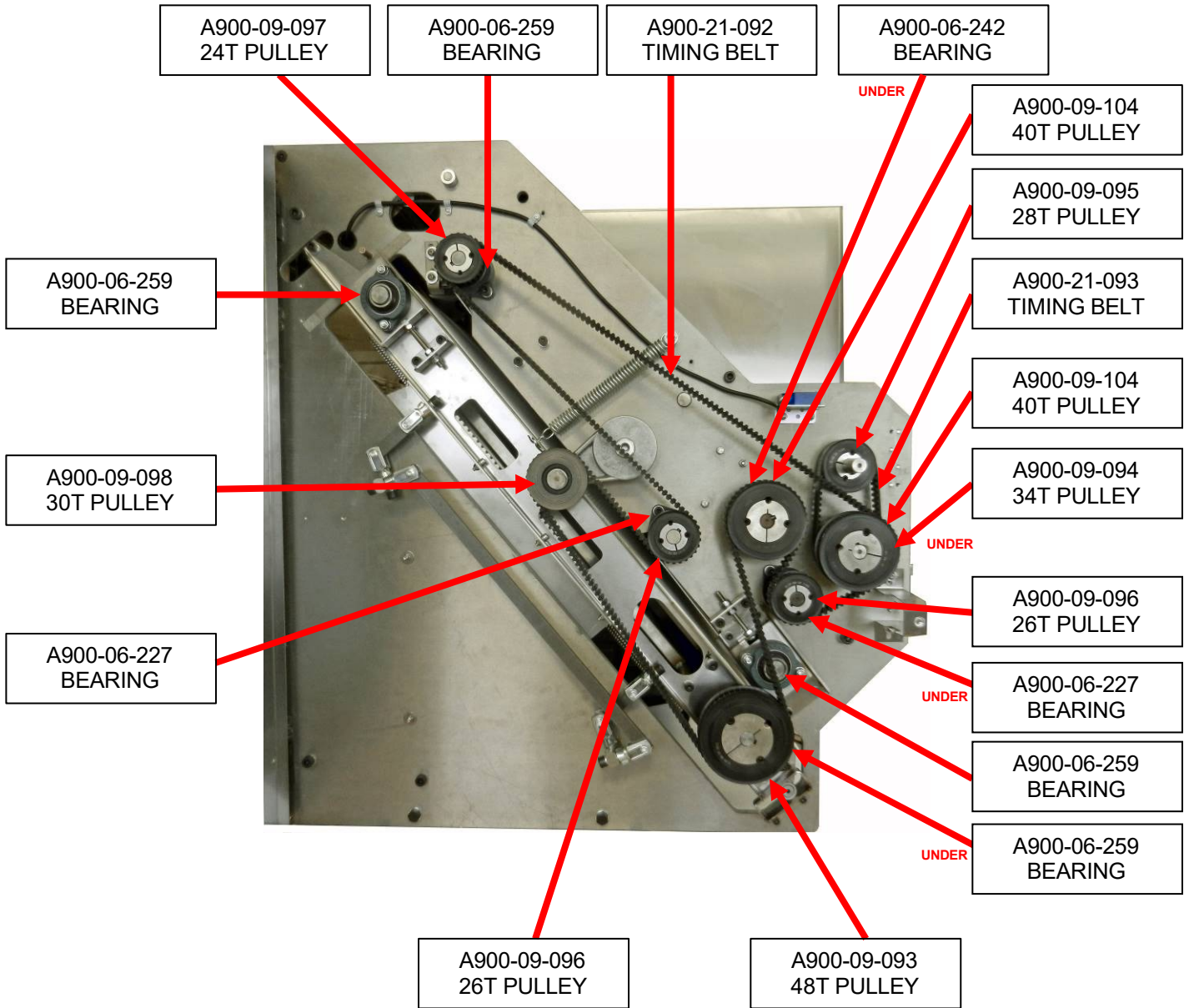

		PART NO.
<b>PULLEY</b>	48T	A900-09-093
	34T	A900-09-094
	28T	A900-09-095
	26T	A900-09-096
<b>BELT -- DOUBLE SIDED LARGE</b>		A900-21-092
	<b>-- TIMING BELT</b>	A900-21-093



## **13.0 MOULDER ELECTRICAL INFORMATION**

IF IN ANY DOUBT - ASK

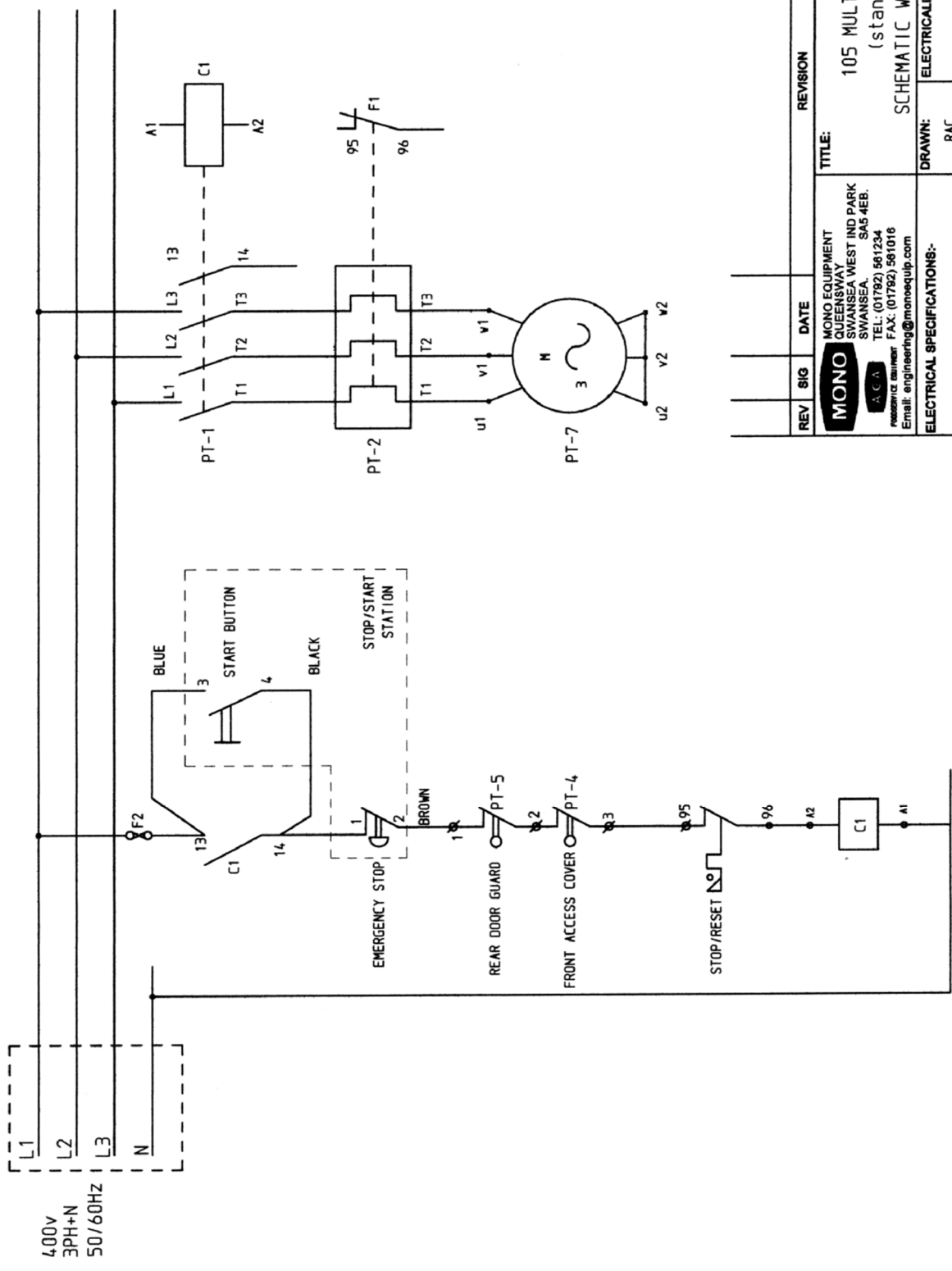

400V  
3PH+N  
50/60Hz

L1  
L2  
L3  
N

REV	SIG	DATE	REVISION	ECN NO.
<p><b>MONO</b> EQUIPMENT                  QUEENSWAY                  SWANSEA WEST IND PARK                  SWANSEA, SA5 4EB.                  TEL: (01792) 561234                  FAX: (01792) 561016                  Email: <a href="mailto:engineering@monoequip.com">engineering@monoequip.com</a></p>				
<p><b>MONO</b> EQUIPMENT                  QUEENSWAY                  SWANSEA WEST IND PARK                  SWANSEA, SA5 4EB.                  TEL: (01792) 561234                  FAX: (01792) 561016                  Email: <a href="mailto:engineering@monoequip.com">engineering@monoequip.com</a></p>			<p>TITLE:                  105 MULTI-MOULDER                  (standalone)                  SCHEMATIC WIRING DIAGRAM                  ELECTRICALLY APPROVED BY:                  RAC</p>	
<p>ELECTRICAL SPECIFICATIONS:-                  415V 3PH 50/60HZ</p>			<p>DATE:                  17-4-08                  DRAWING NO.                  M105E25-00100</p>	

COPYRIGHT ©1998 - THIS DESIGN/DRAWING IS THE PROPERTY OF MONO EQUIPMENT LTD. AND MUST NOT BE REPRODUCED, COPIED, NOR ITS CONTENTS DIVULGED WITHOUT PRIOR WRITTEN PERMISSION.

## **105 Stand Alone Moulder Electrical Parts List**

1. contactor – B801-08-019
2. overload – B801-01-046
3. pushbutton station – 103-25-00600
  - 3a. E stop button – B801-12-008
  - 3b. n/c contact block – B801-14-001
  - 3c. E stop legend – B801-15-001
  - 3d. start button – B801-12-029
  - 3e. n/o contact block – B801-14-002
  - 3f. start legend – B801-15-002
4. Front access cover switch – B818-07-011
5. Rear access cover switch – B818-07-010
6. Motor – B912-74-016
7. Control fuse – B842-85-037



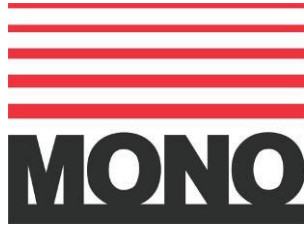

**MONO Equipment**  
Queensway,  
Swansea West Industrial Park,  
Swansea,  
SA5 4EB  
UK

Tel. +44(0)1792 561234

Spares Tel. +44(0)1792 564039

Email: [mono@monoequip.com](mailto:mono@monoequip.com)

**[www.monoequip.com](http://www.monoequip.com)**

As it is our policy to improve our machines continuously, we reserve the right to change specifications without prior notice.

□ **DISPOSAL**

**CARE SHOULD BE TAKEN WHEN THE MACHINE COMES TO THE END OF ITS WORKING LIFE. ALL PARTS SHOULD BE DISPOSED OF IN THE APPROPRIATE PLACE, EITHER RECYCLING OR OTHER MEANS AS THE LAW PERMITS AT THE TIME.**