

Enter **Serial Nos.** here.

PROVER

DIVIDER

MOULDER

ROUNDER

In the event of an enquiry please  
quote these serial numbers.



# Fusion PRO

BREAD PLANT

OPERATING AND MAINTENANCE MANUAL

# IMPORTANT NOTICES

## SAFETY SYMBOLS

The following safety symbols are used throughout this product documentation and manual (available at [www.monoequip.com](http://www.monoequip.com)).

Before using your new equipment, read the instruction manual carefully and pay special attention to information marked with the following symbols.



### **WARNING**

Indicates a hazardous situation which, if not avoided, will result in death or serious injury.



### **WARNING**

Indicates a hazardous situation which, if not avoided, will result in electric shock.



### **CAUTION**

Indicates a hazardous situation which, if not avoided, will result in minor or moderate injury.



**DO NOT TRY TO DISABLE ANY SAFETY DEVICES,  
THEY ARE FITTED FOR YOUR SAFETY.**



### **NOTE: DIVIDER OIL**

**DO NOT USE ORDINARY VEGETABLE OIL FROM SHOP SHELVES,  
IN THE DIVIDER**

*THIS WILL FORM A GUM-LIKE RESIDUE, CAUSING STICKING AND  
POSSIBLE DAMAGE TO THE MACHINE.*

MONO RECOMMENDS THE USE OF “**CRODA SUPER WUNDROL**”  
(AVAILABLE FROM MONO. PART NUMBER “**A900-25-272**”)

# **ELECTRICAL SAFETY AND ADVICE REGARDING SUPPLEMENTARY ELECTRICAL PROTECTION**

Commercial bakeries, kitchens and food service areas are environments where electrical appliances may be located close to liquids, or operate in and around damp conditions, or where restricted movement for installation and service is evident.

The installation and periodic inspection of the appliance should only be undertaken by a qualified, skilled and competent electrician, and connected to the correct supply suitable for the load as stipulated by the appliance data label.

The electrical installation and connections should meet the necessary requirements of the local electrical wiring regulations and any electrical safety guidelines.

## **We Recommend:**

- Supplementary electrical protection with the use of a residual current device (RCD)
- Fixed wiring appliances incorporate a locally situated switch disconnector to connect to, which is easily accessible for switching off and safe isolation purposes. The switch disconnector must meet the specification requirements of IEC 60947.

## **Your attention is drawn to:**

### **BS 7671:2018 – Guidance Note 8 – 8.13 : Other locations of increased risk**

It is recognised that there may be locations of increased risk of electrical shock other than those specifically addressed in Part 7 of BS 7671. Examples of such locations could include laundries where there are washing and drying machines in close proximity, and water is present, and commercial kitchens with stainless steel units, where once again, water is present. Where, because of the perception of additional risks being likely, the installation designer decides that an installation or location warrants further protective measures, the options available includes:

- Automatic Disconnection of Supply (ADS) by means of a residual current device having a residual operating current not exceeding 30 mA;
- Supplementary protective equipotential bonding; and
- Reduction of maximum fault clearance time.

The provision of RCDs and supplementary bonding must be specified by the host organisation's appointed installation designer or electrical contractor and installed by a suitably qualified and competent electrician so as to comply with Regulations 419.2 and 544.2.



The supply to this machine must be protected by a **30mA Type B RCD**



## DECLARATION OF CONFORMITY

We hereby declare that this machine complies with the essential health and safety requirements of :-

- The Machinery Directive 2006 / 42 / EC
- The Low voltage Directive 2014 / 35/ EC
- The requirements of the Electromagnetic Compatibility Directive 2004 / 108EC, 91 / 263 / EEC, 92 / 31 / EEC  
Incorporating standards  
EN55014-1:2006+A1:2009+A2:2011  
EN55014-2:1997+A1:2001+A2:2008
- The General Safety of Machinery and food processing Standards applicable
- Materials and Articles intended to come into contact with food Regulation (EC) No. 1935 / 2004

<b>Signed</b>	
<b>G.A.Williams – Quality Manager</b>	

<b>Date</b>	
-------------	--

<b>Machine FG Code.</b>		<b>Machine Serial No.</b>	
-----------------------------	--	-------------------------------	--

A technical construction file for this machine is retained at the following address:

**MONO EQUIPMENT**  
Queensway,  
Swansea West Industrial Park,  
Swansea  
SA5 4EB  
UK

**MONO EQUIPMENT** is a business name of **AFE GROUP Ltd**  
Registered in England No.3872673    VAT registration No.923428136

Registered office: Unit 9, Bryggen Road,  
North Lynn Industrial Estate,  
Kings Lynn,  
Norfolk,  
PE30 2HZ



**SECTION 1 - BREAD PLANT ASSEMBLED**

INSTALLATION, CLEANING, MAIN CONTROLS, AND  
BREAD PLANT OPERATION

**SECTION 2 - DOUGH DIVIDER**

MAIN INSTRUCTIONS

**SECTION 3 - MOULDER**

MAIN INSTRUCTIONS

**SECTION 4 - ROUNDER**

MAIN INSTRUCTIONS

# CONTENTS

---

## **SECTION 1 – BREAD PLANT ASSEMBLED**

<b>1.0</b>	<b>INTRODUCTION</b> .....	<i>Description of plant</i> .....	<b>11</b>
<b>2.0</b>	<b>GENERAL DIMENSIONS</b> .....	<i>Prover, Divider, Moulder, and Rounder</i> .....	<b>12</b>
	Overall dimensions .....	<i>Bread plant assembled</i> .....	14
<b>3.0</b>	<b>SPECIFICATIONS</b> .....	<i>Power, weight, and noise level</i> .....	<b>15</b>
<b>4.0</b>	<b>SAFETY</b> .....	<i>Precautions when using the equipment</i> .....	<b>16</b>
<b>5.0</b>	<b>INSTALLATION</b> .....	<i>General, Divider, Rounder, and Moulder</i> .....	<b>17</b>
<b>6.0</b>	<b>ISOLATION</b> .....	<i>Emergency stop; turning off for cleaning and servicing</i> .....	<b>22</b>
<b>7.0</b>	<b>CLEANING</b> .....		<b>23</b>
	▪ <b>Prover</b>		
	Daily cleaning .....		23
	Weekly cleaning .....		25
	Carrier pocket removal .....		25
	▪ <b>Divider</b>		
	Daily cleaning .....		26
	Weekly cleaning .....		29
	▪ <b>Moulder</b>		
	Daily cleaning .....		30
	Weekly cleaning .....		36
	▪ <b>Rounder</b>		
	Daily cleaning .....		37
	Weekly cleaning .....		37
<b>8.0</b>	<b>OPERATING INSTRUCTIONS</b> .....		<b>34</b>
	a. Operation of the bread plant .....		38
	The controls explained .....		38
	Warning lights .....		40
	Moulder infeed conveyor curling chain setting .....		41
	Flour duster operation .....		42
	b. How to operate the bread plant .....		43
<b>9.0</b>	<b>ELECTRICAL INFORMATION</b> .....	<i>Wiring diagrams</i> .....	<b>44</b>
<b>10.0</b>	<b>MAINTENANCE</b> .....		<b>53</b>

---

PLEASE READ THESE MORE DETAILED SECTIONS BEFORE USING THIS PLANT

**SECTION 2 - Dough divider**

**SECTION 3 - Moulder**

**SECTION 4 - Rounder**

---

## **SECTION 2 - DOUGH DIVIDER**

1.0	INTRODUCTION .....	57
2.0	GENERAL DIMENSIONS.....	58
3.0	SPECIFICATIONS.....	58
4.0	SAFETY.....	59
5.0	INSTALLATION.....	60
6.0	ISOLATION .....	62
7.0	CLEANING INSTRUCTIONS .....	63
	▪ Daily.....	63
	▪ Weekly .....	67
8.0	OPERATING .....	68
9.0	MAINTENANCE .....	71
10.0	TROUBLESHOOTING .....	73
11.0	SPARES AND SERVICE.....	80

---

**FOR SERVICE AND SPARES RING: 01792 564044**

---

12.0	ELECTRICAL INFORMATION SECTION .....	81
------	--------------------------------------	----

**SECTION 3 – MOULDER**

- 1.0 INTRODUCTION ..... 88**
- 2.0 OVERALL DIMENSIONS ..... 88**
- 3.0 SPECIFICATIONS ..... 89**
- 4.0 SAFETY ..... 90**
- 5.0 INSTALLATION ..... 91**
- 6.0 ISOLATION ..... 92**
- 7.0 CLEANING INSTRUCTIONS ..... 93**
  - Daily ..... 93
  - Weekly ..... 99
- 8.0 OPERATING INFORMATION ..... 100**
- 9.0 OPERATING INSTRUCTIONS ..... 101**
  - Moulding between belts (French stick and petit pan) ..... 102
  - Moulding Between Rear Belt & Pressure Board (Tin and Bloomers) ..... 103
- 10.0 MAINTENANCE ..... 104**
- 11.0 TROUBLESHOOTING ..... 106**
- 12.0 SPARES AND SERVICE ..... 107**

---

**FOR SERVICE AND SPARES RING: 01792 564044**

---

- 13.0 MOULDER ELECTRICAL INFORMATION ..... 110**



**SECTION 4 – ROUNDER**

1.0 INTRODUCTION ..... 114

2.0 OVERALL DIMENSIONS ..... 114

3.0 SPECIFICATIONS ..... 115

4.0 SAFETY ..... 116

5.0 INSTALLATION ..... 117

6.0 ISOLATION ..... 118

7.0 CLEANING ..... 119

8.0 OPERATING CONTROLS ..... 120

9.0 TROUBLESHOOTING ..... 121

10.0 SPARES AND SERVICE ..... 122

---

**FOR SERVICE AND SPARES RING: 01792 564044**

---

11.0 MOULDER ELECTRICAL INFORMATION ..... 123

11.0 MAINTENANCE ..... 126

# SECTION 1



BREADPLANT ASSEMBLED

# 1.0 INTRODUCTION

The **Mono FUSION PRO** bread plant is a fully integrated unit enabling rapid change of product lines without moving any items of equipment.

It consists of four machines:

1. **DIVIDER** ..... Divides the dough to size required
2. **ROUNDER** ..... Rounds the dough ready for even proving
3. **PROVER** ..... Allows the dough to prove
4. **MOULDER** ..... Moulds dough to shape required

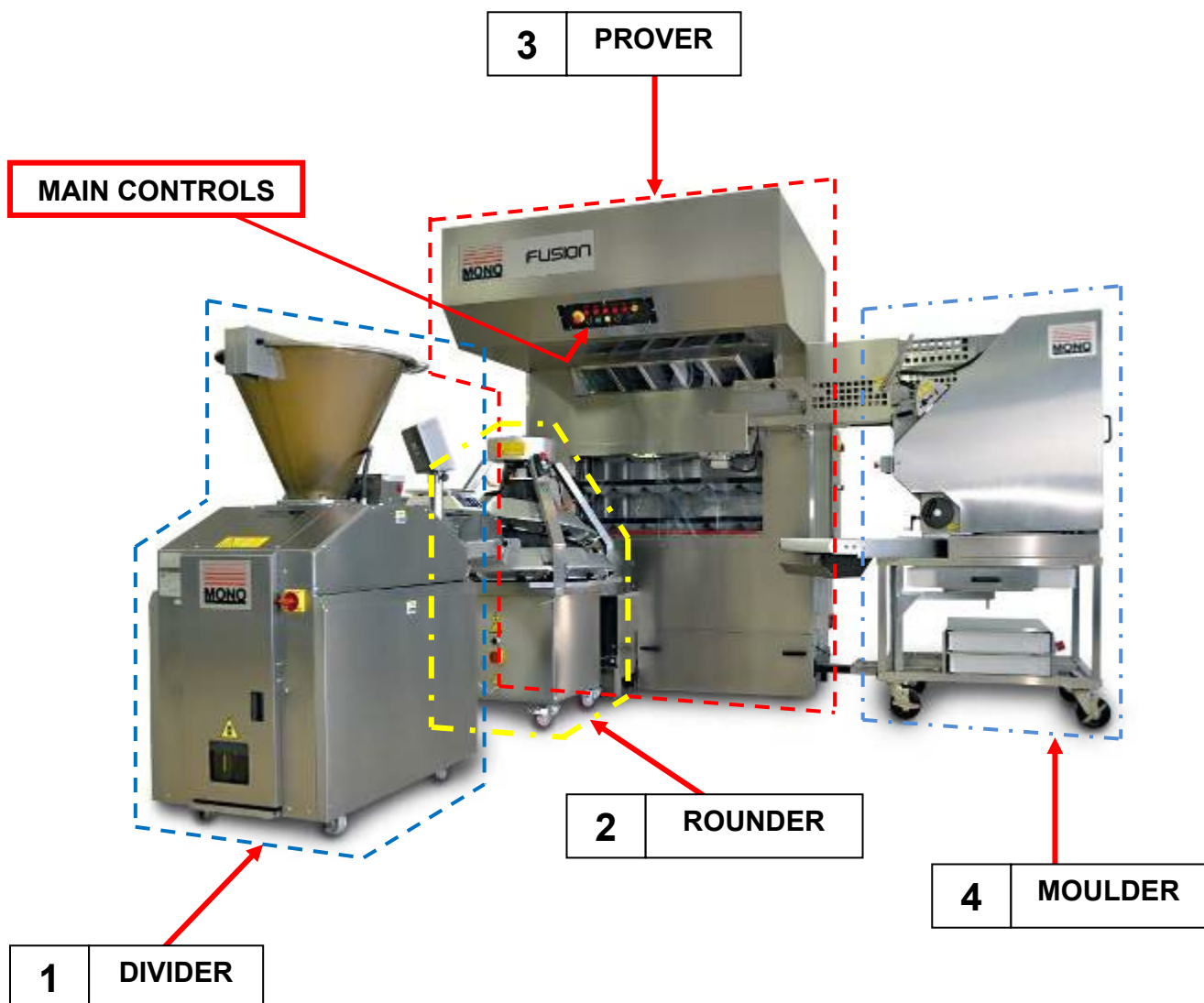

# 2.0 GENERAL DIMENSIONS

## PROVER

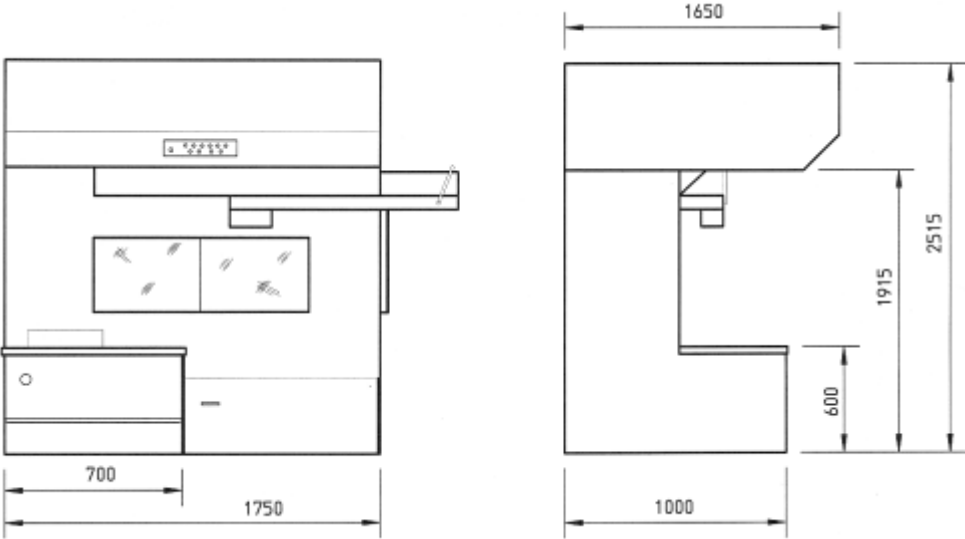

**Height:** 2515mm.  
**Depth:** 1650mm.  
**Width:** 1750mm.

## MOULDER

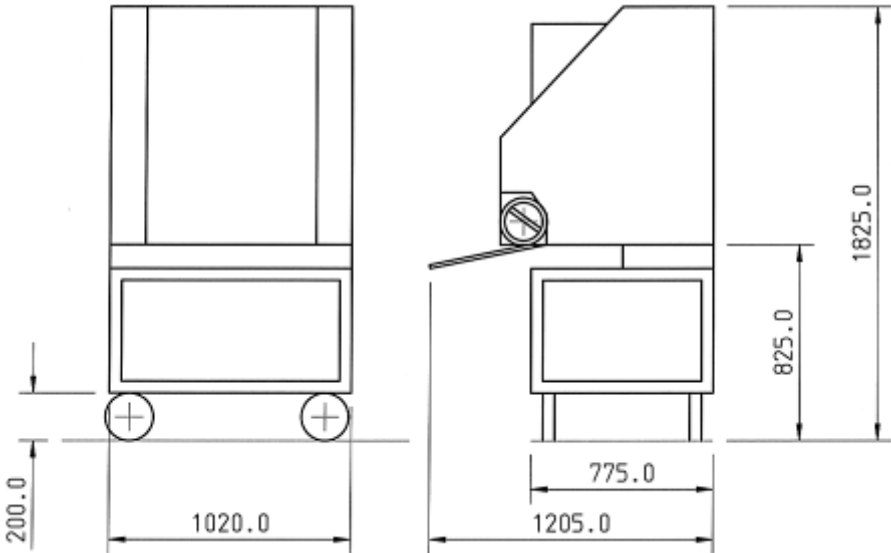

**Height:** 1825mm.  
**Depth:** 1205mm.  
**Width:** 1020mm.

## DIVIDER

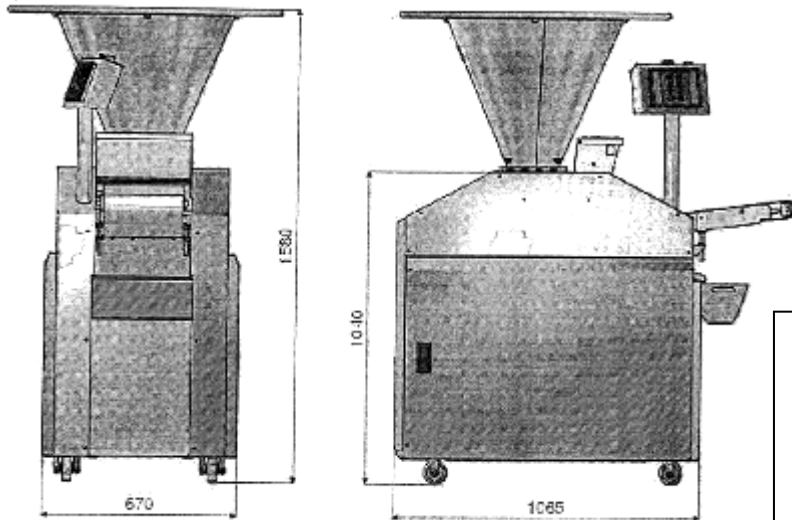

**Height:**  
1580mm

**Depth:**  
1065mm.  
(inc. conveyor 1400mm)

**Width:**  
670mm

## CONICAL ROUNDER

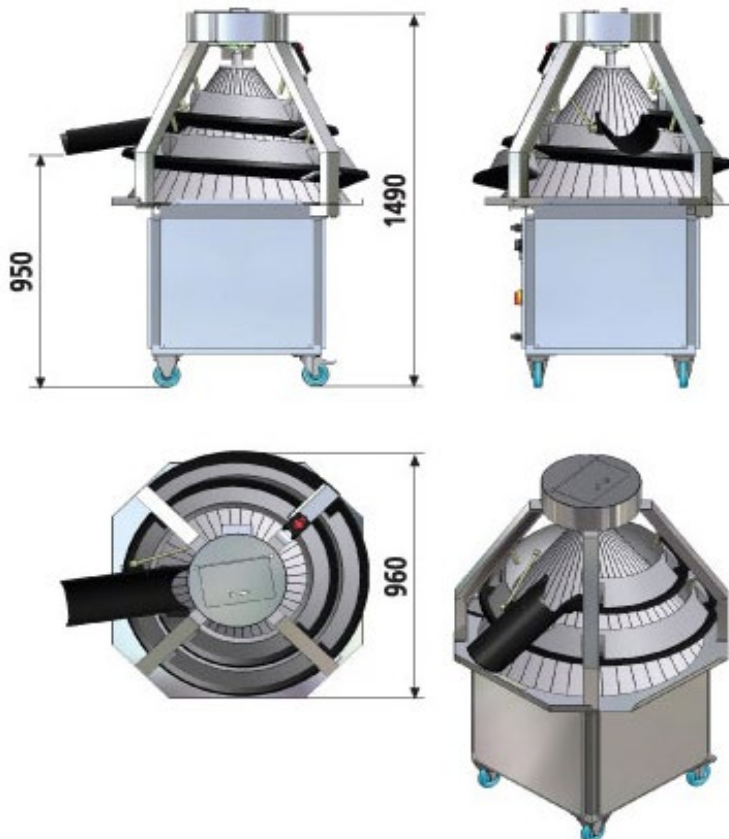

**Height:**  
1490mm

**Depth:**  
960mm.

**Width:**  
960mm

# OVERALL DIMENSIONS

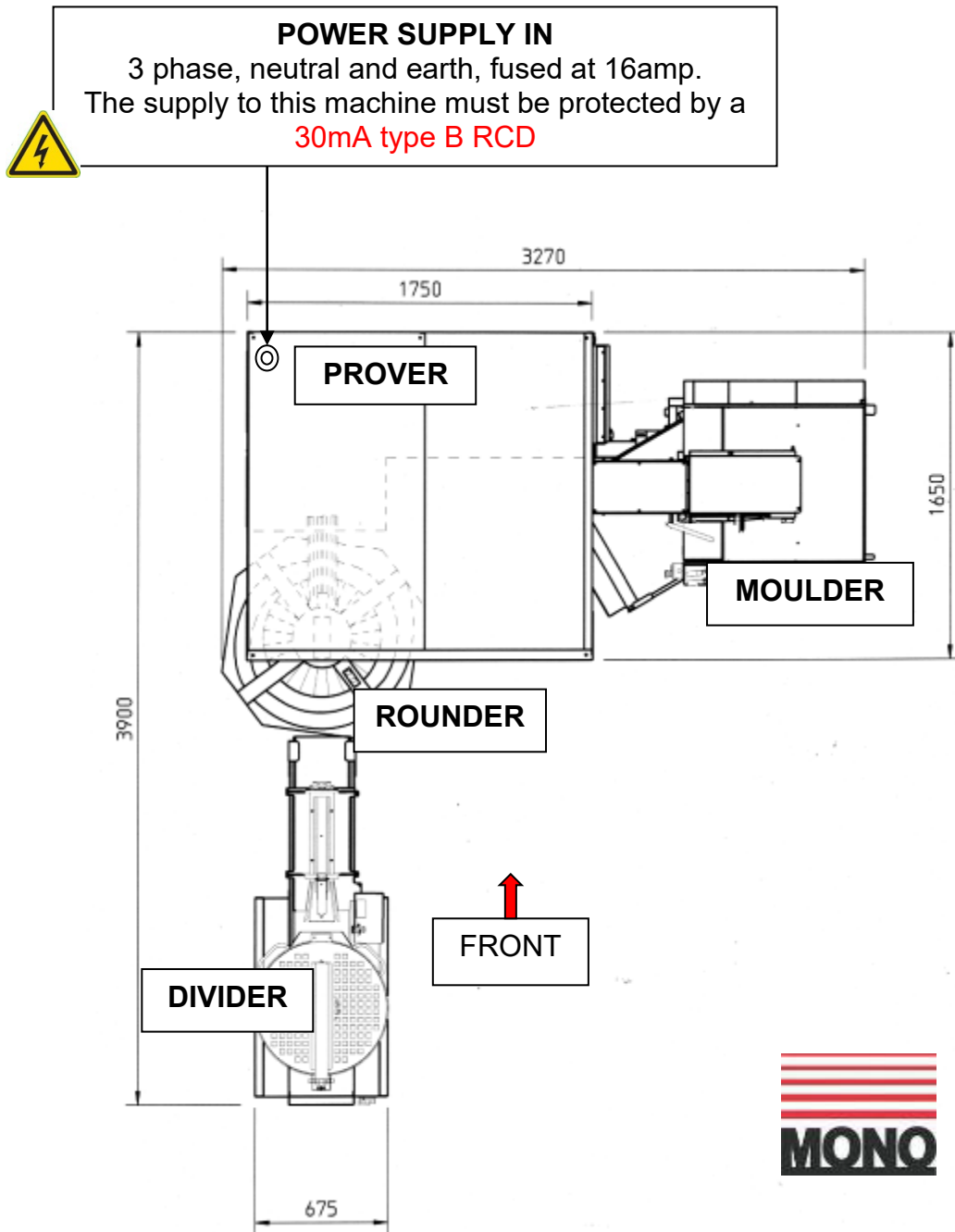

**PLAN VIEW**

TOTAL AREA REQUIRED = approx.3270 X approx.3900  
HEIGHT (PROVER) = 2520  
DIMENSIONS IN MILLIMETRES

## 3.0 SPECIFICATIONS

---

### TOTAL PLANT

3 phase, neutral and earth, fused at 16amp

(ALL MACHINES CONNECTED TOGETHER)

**POWER: 5.5kW**



The supply to this machine must be protected by a **30mA type B RCD**

### PROVER

POWER: **0.86kW**

WEIGHT: **1470kg**

NOISE LEVEL: **Less than 85dB**

---

### MOULDER

POWER: **0.75kW**

WEIGHT: **430kg**

NOISE LEVEL: **Less than 85dB**

---

### DIVIDER

POWER: **3.2kW**

WEIGHT: **500kg**

NOISE LEVEL: **Less than 85dB**

---

### CONICAL ROUNDER

POWER: **0.55kW**

WEIGHT: **205kg**

NOISE LEVEL: **Less than 85dB**

## 4.0 SAFETY



IF YOU ENCOUNTER ANY ISSUE WITH THIS EQUIPMENT THAT YOU HAVE NOT BEEN TRAINED FOR, YOU MUST CONTACT YOUR INSTORE TECHNICIAN OR MANAGER.



- 1 Never use a machine in a faulty condition and always report any damage.
- 2 Only trained engineers may remove any part that requires a tool to do so.
- 3 People undergoing training on this machine must be under direct supervision of a fully trained person.



- 4 Use of this machine can prove dangerous if:
  - the machine is operated by untrained or unskilled staff
  - the machine is not used for its intended purpose
  - the machine is not operated correctly



- 5 Always ensure hands are dry before touching any electrical appliance (including cable, switches and plugs).

- 6 Do not operate the machine with any panels or guards removed.



- *All safety devices applied to the machine during manufacture and the operating instructions in this manual are required to operate this machine safely. The owner and the operator are responsible for operating this machine safely.*

- ***DO NOT TRY TO DISABLE ANY SAFETY DEVICES, THEY ARE FITTED FOR YOUR SAFETY.***

- 7 NEVER move machinery by pulling on the power cords or cables.

- 8 No loose clothing or jewellery should be worn while operating this machine

- 9 The bakery manager or the bakery supervisor must carry out daily safety checks on this machine.

- 10 No one under the age of 16 may operate this machine.

- 11 No one under the age of 18 may clean this machine under any circumstances.



- 12 DO NOT STAND ON ANYTHING TO LOAD THE DIVIDER HOPPER.



- 13 DO NOT STAND ON OR STORE ITEMS ON THE PROVER ROOF.



**ALL CLEANING AND MAINTENANCE OPERATIONS MUST BE MADE WITH MACHINE DISCONNECTED FROM THE POWER SUPPLY.**



## 5.0 GENERAL INSTALLATION

The supply to this machine must be protected by a **30mA type B RCD** 

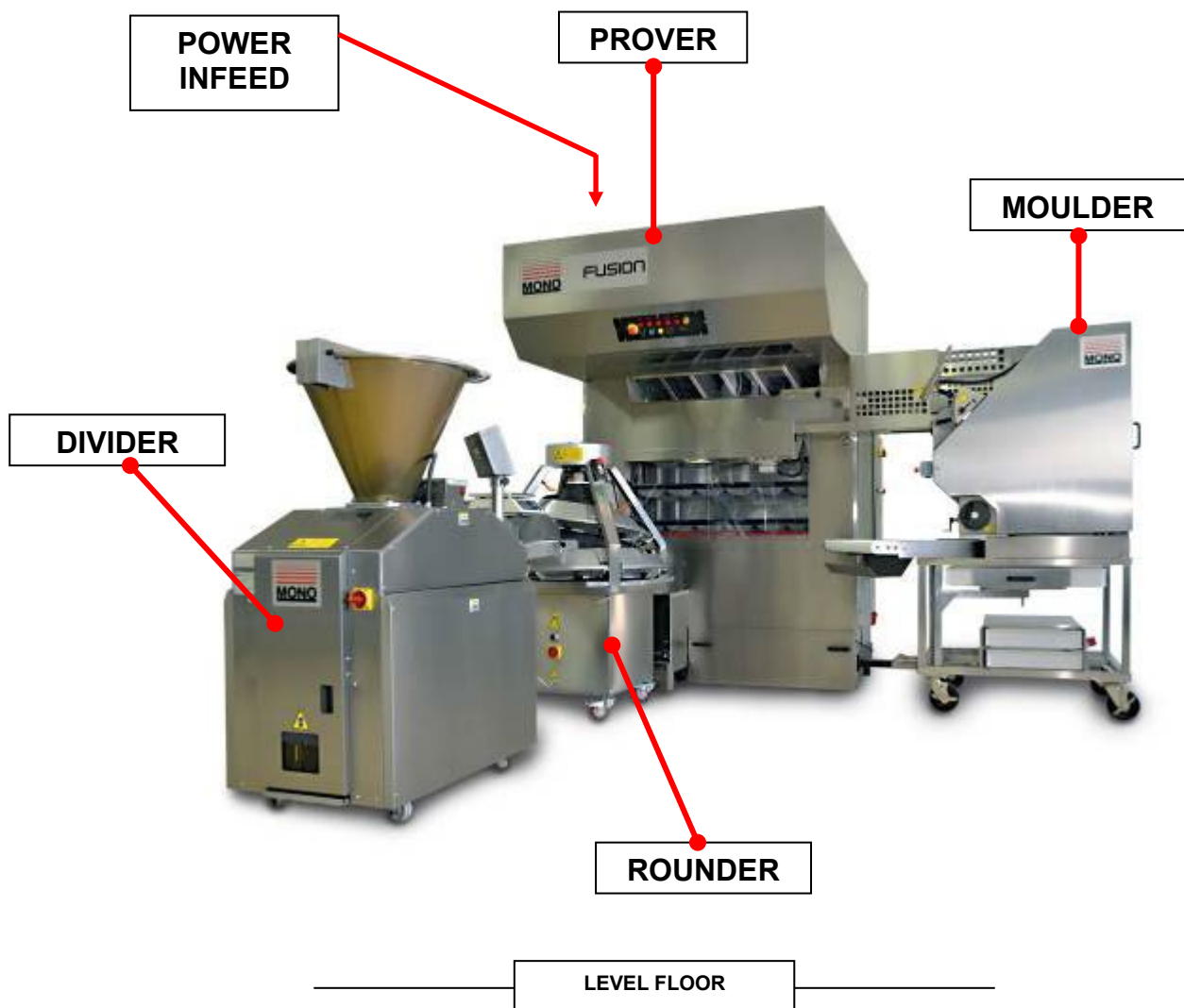

1. The plant should be positioned on a solid level floor.
2. The plant should be connected to a mains wall isolator.
3. Insert rounder plug into the correct socket on the front of the prover.
4. Insert divider plug into the correct socket on the front of the prover.
5. Insert moulder plug into the correct socket on the side of the prover.

### **DO NOT ATTEMPT TO LIFT THE DIVIDER BY HUMAN FORCE (LIFTING)**

- Use of a **forklift or crane** is recommended for lifting or the machine can be pushed on the castors provided.
- **To lift with a forklift** - the machine must be secured to a pallet.
- **To lift with a crane** - lifting eyes are provided.



**LIFTING EYES**

**Check that the power rating on the serial number plate matches the supply that the machine is to be connected to.**

- The Dough Divider should be connected to the correct socket on the prover.

**DIVIDER SOCKET**



- ❑ Connect the electrical cable to the socket on the prover drive box front.
- ❑ Check the machine after installation to ensure the belt moves in the correct direction indicated (see arrow in photo below).

*(If wrong - swap positions of any two of the three phase carrying wires in the plug.  
This should be factory set and not need to be done)*

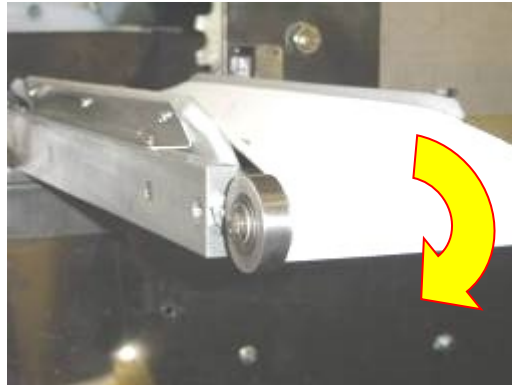

- ❑ Fill oil tank to 2/3 level, with your company recommended food safe oil.

**○ WARNING!**

**DO NOT USE ORDINARY VEGETABLE OIL FROM SHOP SHELVES, IN THE DIVIDER**  
*THIS WILL FORM A GUM-LIKE RESIDUE,  
CAUSING STICKING AND POSSIBLE DAMAGE TO THE MACHINE.*

MONO RECOMMENDS THE USE OF “**CRODA SUPER WUNDROL**”  
(AVAILABLE FROM MONO. **PART NUMBER “A900-25-272”**)

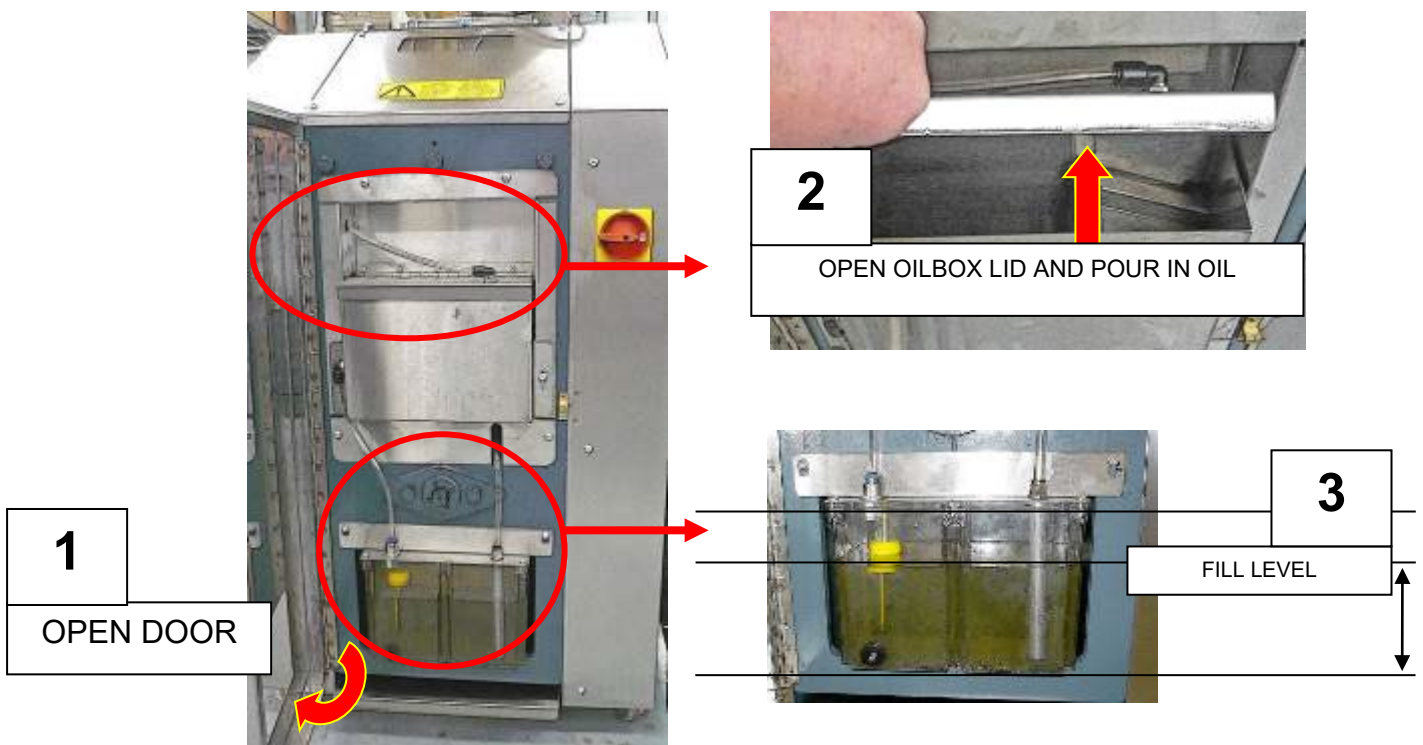

# Positioning Divider and Rounder.

- 1 Ensure the divider is standing on a solid level floor.
- 2 Correctly position the rounder so that dough will leave the out chute and roll down the infeed chute of the prover.  
(or use the locator mechanism if included)
- 3 Correctly position the divider so that dough will leave the conveyor and drop down into the rounder.  
(or use the locator mechanism if included)

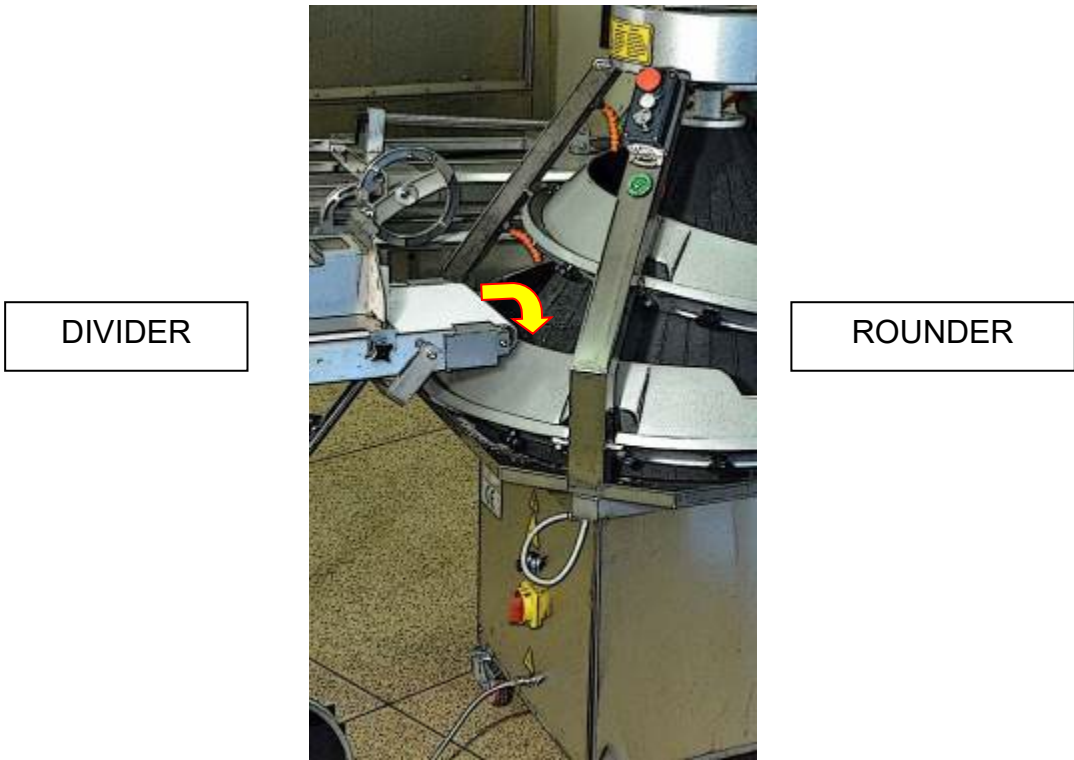

- 4 After the connection is made, lock the two front castors into place on both machines.

# Positioning Moulder.

- 1 Ensure the moulder is standing on a solid level floor.
- 2 Correctly position the moulder using the male locator on the base.
- 3 The locator should be pushed in until the end of it pushes up against the stop and the clip lines up.
- 4 Fasten the clip
- 5 After the connection is made, lock the two locking castors into place.

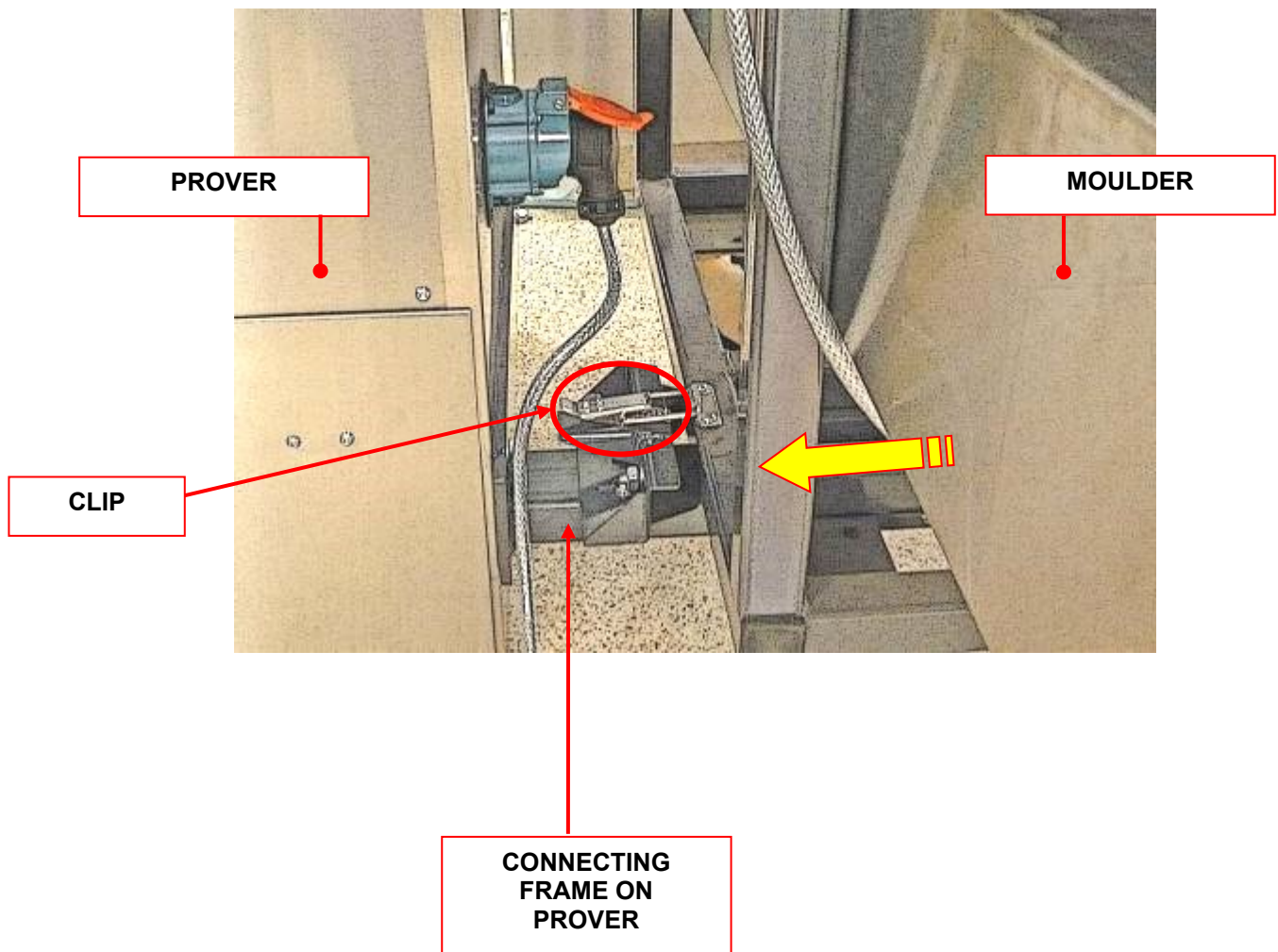

# 6.0 ISOLATION



## EMERGENCY STOP BUTTONS

### TO STOP THE BREAD PLANT IN AN EMERGENCY

Switch off at the main isolator, or use the **emergency stop button** on the overhead panel

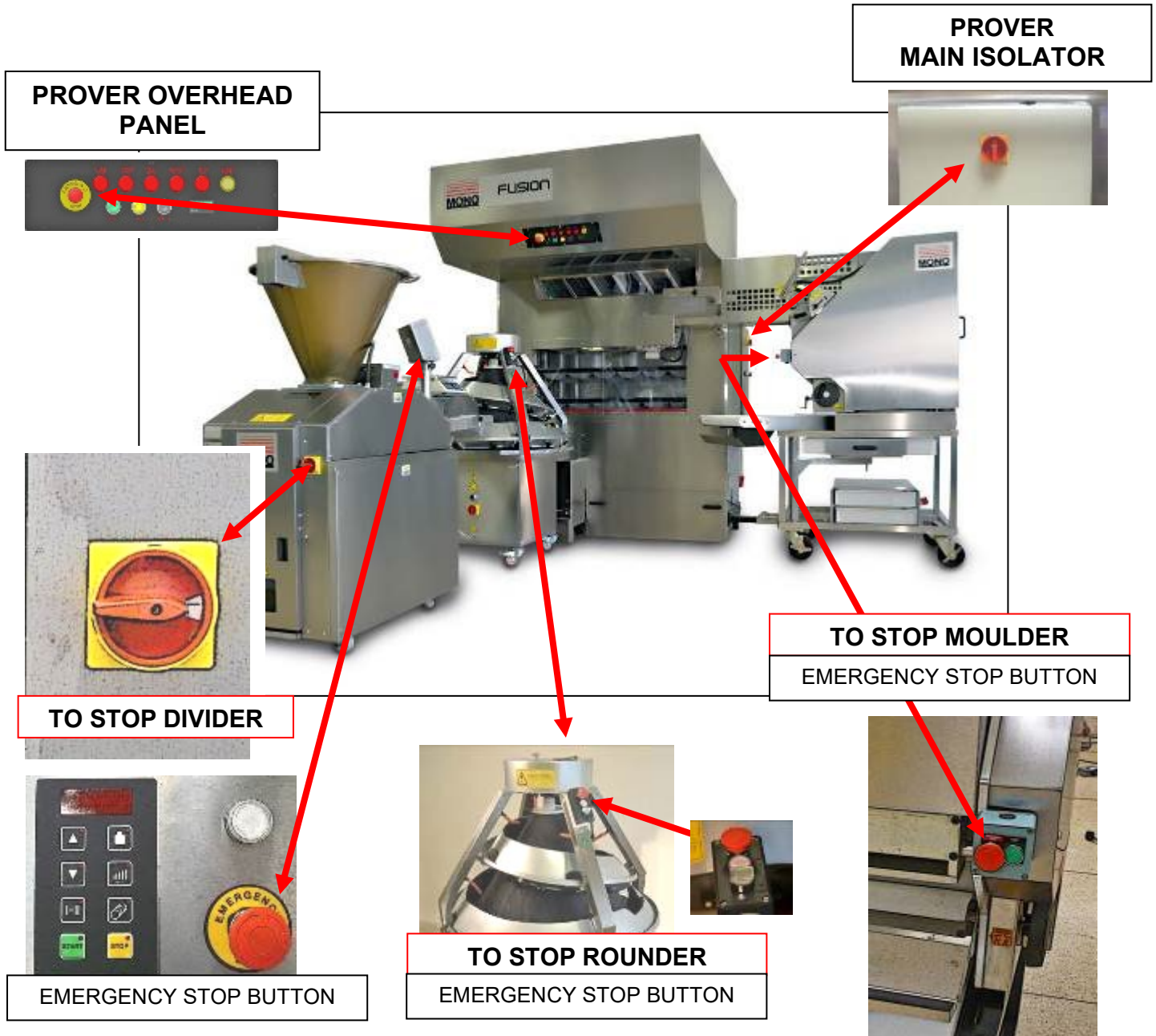

### WARNING

Except in an emergency, do not halt the prover with dough in the carriers and leave it. Dough will adhere to the pockets and may cause the prover to malfunction.

**USE THE "PARK" BUTTON TO STOP THE PROVER IF NOT AN EMERGENCY.**

## 7.0 CLEANING

PROVER  
DIVIDER  
MOULDER  
ROUNDER



**SWITCH OFF AND ISOLATE THE MACHINES FROM MAINS SUPPLY BEFORE COMMENCING CLEANING**



MAINS SUPPLY ISOLATOR

### NOTES

- 1. Except in an emergency**, do not halt the prover with dough in the carriers and leave it. Dough will adhere to the pockets and may cause the machine to malfunction.
- 2.** ALWAYS CHECK THE POCKETS FOR ADHERING DOUGH AND REMOVE AS SOON AS POSSIBLE. DO NOT WAIT FOR DAILY CLEANING IF IN DOUBT.
- 3. If not an emergency**, use the “PARK” button. This will stop the prover in the correct position.



- 4.** NEVER LEAVE THE DIVIDER WITH DOUGH IN THE DOUGH CHAMBER AS PRESSURES CAN BUILD UP AS THE DOUGH PROVES.

# PROVER CLEANING INSTRUCTIONS

## DAILY CLEANING

1. Brush the infeed chute [1] ensuring the dough sensor and reflector are clean.
2. Remove the drive box drawer [2] and wash thoroughly, dry and replace.
3. Lift slightly and withdraw the cleaning drawer [3] and remove any dough. Wash thoroughly, dry and replace.
4. Remove the clear transfer window [4] by lifting out of the location channels. Wash and dry.
5. Wipe the window location channels and replace the window.
6. Open the main overhang door [5] (lift, slide back, then hinge down) and check for fallen pieces of dough inside. Brush rear of door and close.
7. Brush the conveyor area [6] and wipe clean the metalwork, paying attention to the inner sides where dough can collect.
8. Wipe over the control box [7] with a damp cloth (do not allow moisture to enter the panel).
9. Brush down the outer sheeting of the machine.

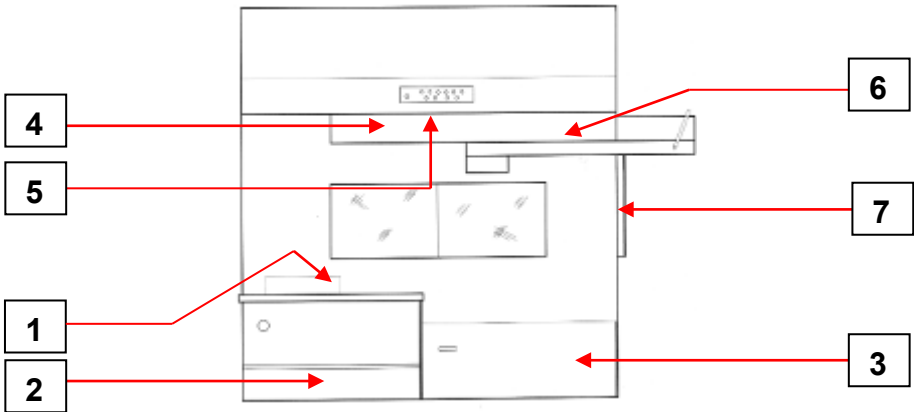

**KEEP WATER AWAY FROM THE MAIN CONTROL PANEL AND ELECTRICAL CONNECTION SOCKETS.**

LEFT HAND VERSION SHOWN



**CAUTION**



ISOLATE THE PROVER FROM THE POWER SUPPLY BEFORE CLEANING.

As daily cleaning and also: -

1. Wipe over all outer sheeting and doors with sanitising solution.

**KEEP WATER AWAY FROM THE MAIN CONTROL PANEL AND ELECTRICAL CONNECTION SOCKETS.**

2. Ensure the top roofing sheeting is clear and clean as required.



**Do not stand on or store items on the roof**

3. Inspect the floor area inside and clean as required.

## CARRIER and POCKET REMOVAL

1. Open the front windows to access carriers.
2. Although not necessary when cleaning and replacing pockets, carriers can be removed if required by pulling chain sideways off the locating pins on the end of the carrier. It is not advisable to remove more than one at a time and note that the carriers are positioned at three link intervals. Note that the end roller should always be towards the rear.
3. Hold the carrier body and pull the blue carrier pocket gently upwards to unclip. *(Note that there are 6 pockets to a carrier and each one can be replaced individually without removing the carrier from the prover)*



**MOULDED CLIPS**



**CARRIER**

# DIVIDER CLEANING INSTRUCTIONS

## DAILY



### NOTE:

**ISOLATE THE DIVIDER FROM THE MAINS SUPPLY BEFORE CLEANING.**

- CLEANING SHOULD ONLY BE CARRIED OUT BY FULLY TRAINED PERSONNEL
- DO NOT USE A HIGH PRESSURE WASHER
- DO NOT USE SOLVENTS OF ANY KIND
- KEEP CLEANING FLUIDS AWAY FROM ELECTRICAL SWITCHES

- 1 Remove any dough residue from interior of the hopper.  
(Only use **plastic scraper**)
- 2 Smear the interior of the hopper with divider oil.
- 3 Check the oil level is correct (refill if required).  
Then run the divider for a minute, using on/off buttons on the control console.  
(This will stop the machine from seizing up by coating the drum with oil)

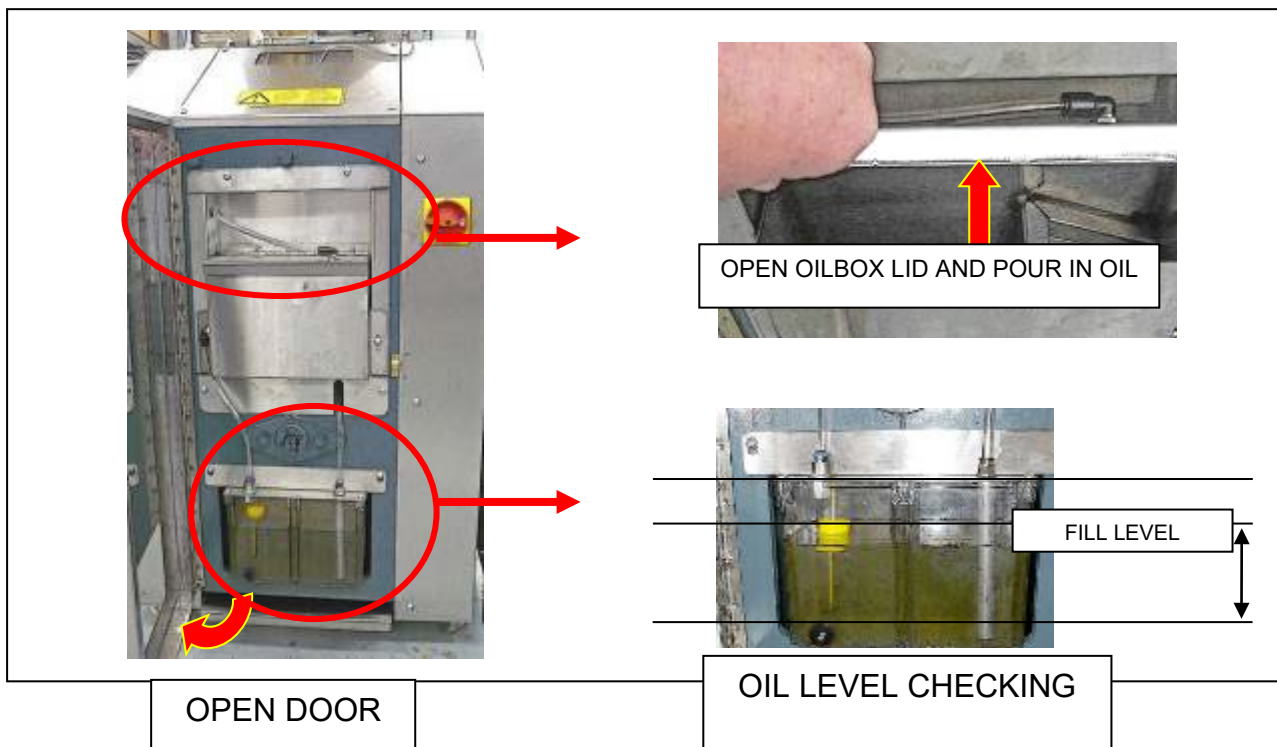

### NOTE:

**THE ABOVE STEPS MUST BE FOLLOWED DAILY, OTHERWISE IT WILL LEAD TO THE BUILD UP OF STARCH AND SEIZURE OF THE MACHINE.**

□ **OFF TAKE CLEANING**

REMOVE SCALES IF FITTED.  
Unplug and lift off.

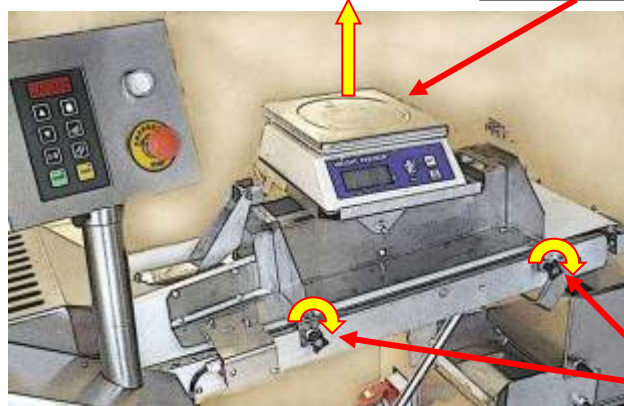

LOOSEN KNOBS | 1

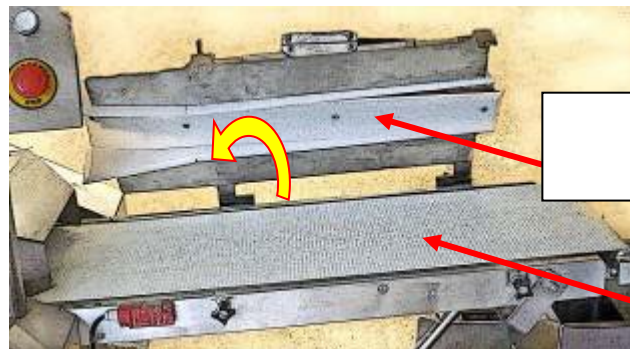

PIVOT  
PRESSURE BOARD | 2

BELT

- 1 Unplug and remove the scales.
- 2 Loosen the two black knobs on the side of the pressure board.
- 3  Pivot the pressure board away from you.  
Help may be required to hold the pressure board while cleaning takes place.
- 4 Remove any dough residue and brush exposed parts.
- 5 Scrape and wipe down the belt. (Only use **plastic scraper**).
- 6 Remove any dough residue from the conveyor metal work and belt surface.
- 7 Lower the pressure board and tighten the two black knobs on the side of the pressure board.
- 8 Replace and plug in the scales.

□ **EXTERNAL CLEANING**

- 1 Brush off any flour residue and scrape as necessary. (Only use **plastic scraper**)
- 2 Brush off loosened dough.
- 3 Make up sterilising solution and hot water.
- 4 Clean the exterior of the divider as necessary working from top to bottom.
- 5 Swab dry with disposable tissue.

□ **UNDER CONVEYOR COLLECTION BOX**

- 1 Brush the chute debris into the collection box.

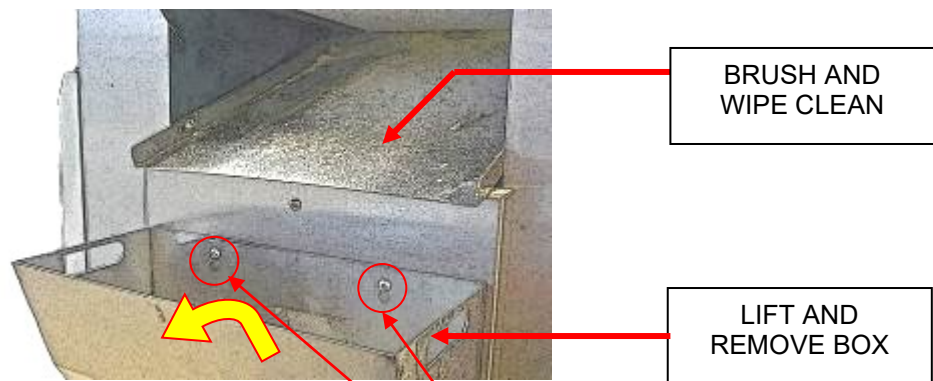

- 2 Lift and remove the collection box and clean.
- 3 Replace the collection box, making sure it is pushed right down on locating screws.

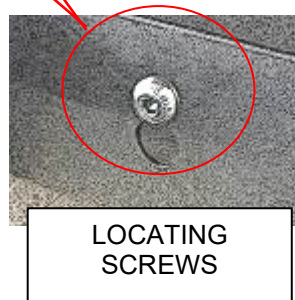

## WEEKLY

**NOTE:**

CLEANING SHOULD ONLY BE CARRIED OUT BY FULLY TRAINED PERSONNEL

**WARNING: ISOLATE DIVIDER FROM MAINS SUPPLY**

1. Scrub wheels with a small nylon cleaning brush or scouring pad and hot water sterilising solution.
2. Clean entire exterior surfaces of the divider, working from top to bottom.

# MOULDER CLEANING INSTRUCTIONS

## DAILY CLEANING INSTRUCTIONS

**NOTE!** - PRIOR TO CLEANING, USE PLASTIC SCRAPERS TO REMOVE SUBSTANTIAL DOUGH PIECES.

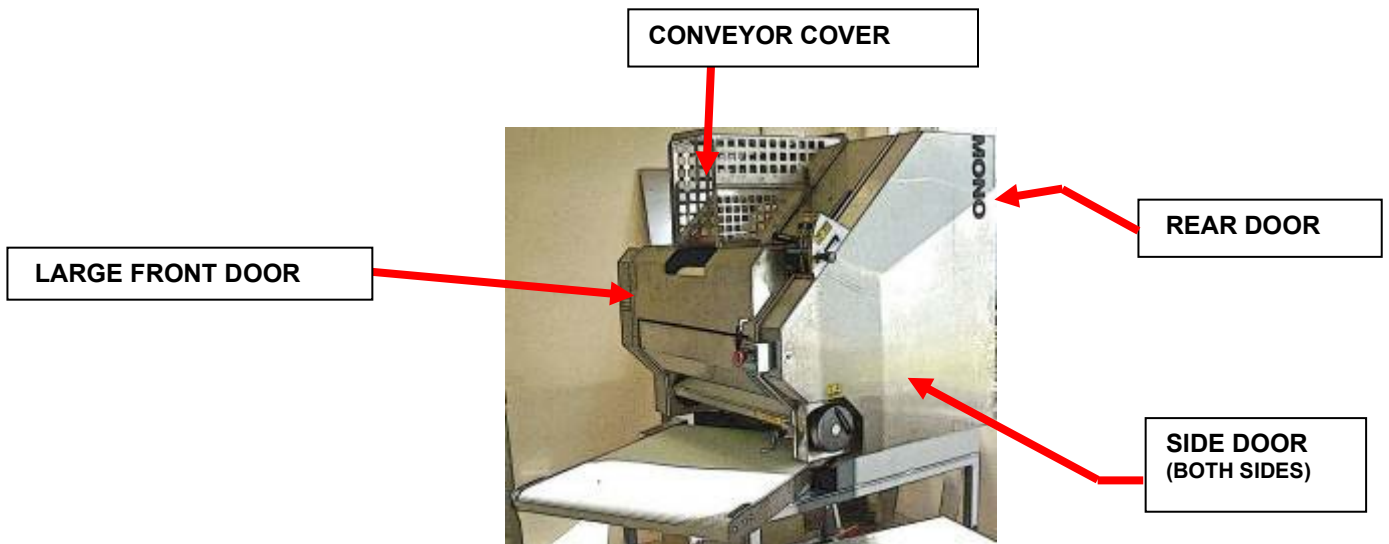

1. Isolate the mains supply (unplug from prover).
2. Open large front door.



SET SHEETING GAP



4. Set sheeting gap to the widest mark and brush out residue from the area, using a plastic scraper on the rollers if required.
5. Clean any residue that has been trapped at the bottom of the belt.  
Scrape exposed surface of the dough-moulding belt with **plastic** scraper.
7. Brush/vacuum the area.

# SCRAPER AND CURLING CHAIN REMOVAL

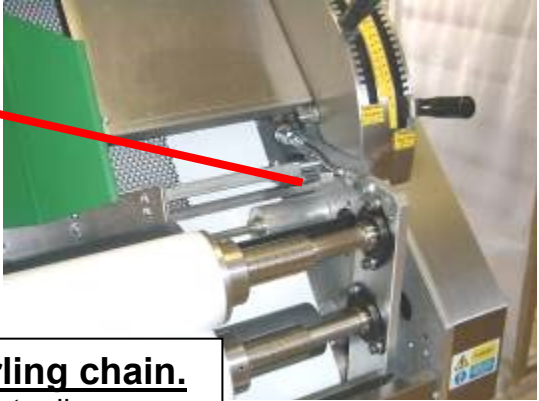

**To remove scraper and curling chain.**  
Slide clips sideways and lift up bar to disengage (one each side).



CLIP CLOSED

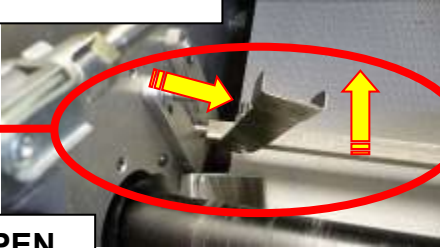

CLIP OPEN

**Detach top of curling chain**  
Lift chain off top bar and remove curling chain and scraper.

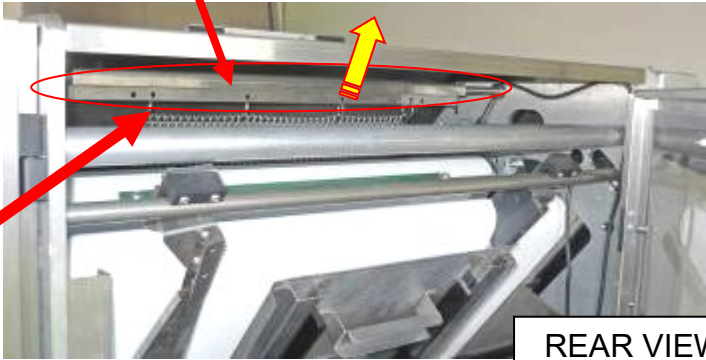

REAR VIEW





**To replace scraper and curling chain.**

Clean and then replace the curling chain by dropping it down the conveyor from the back and clipping in place at the front. (Reverse of removal).

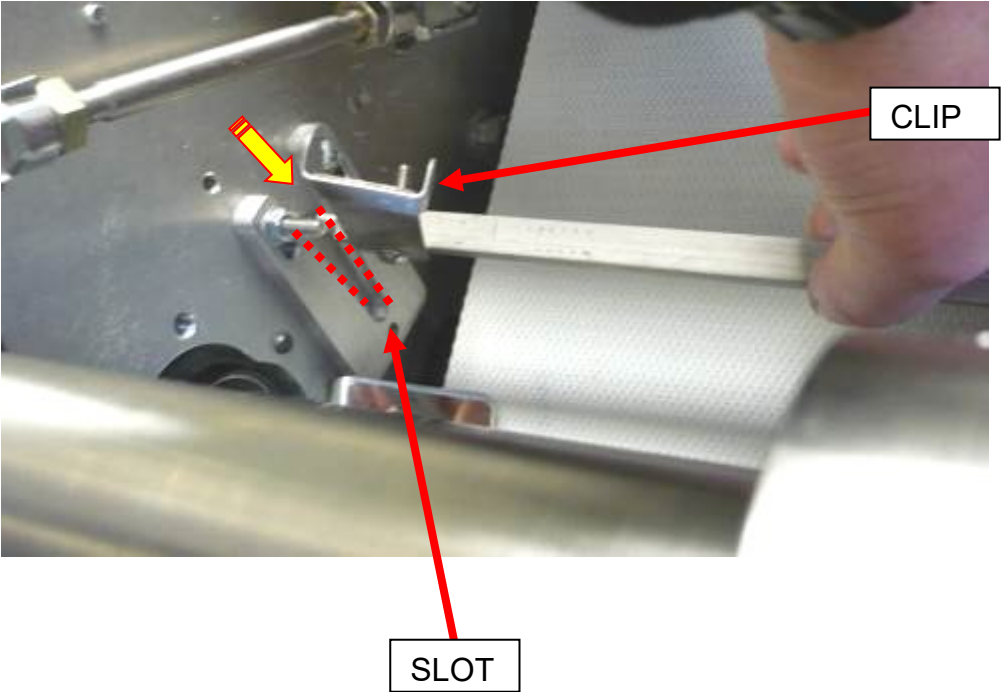

## Pressure Board Removal

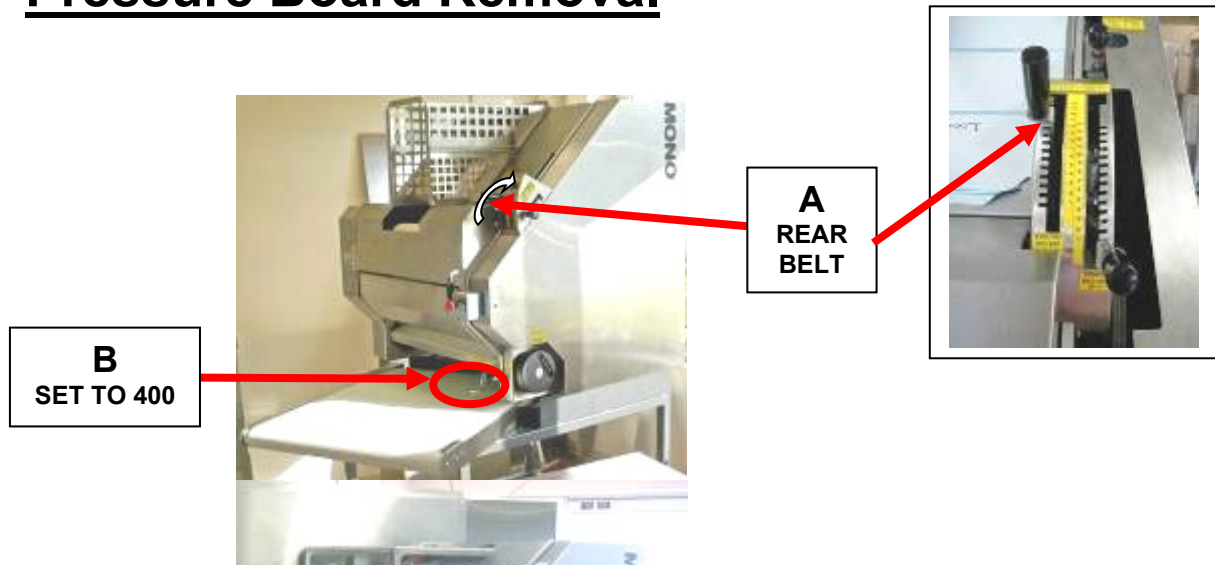

1. Fully lower the rear-moulding belt using lever (A) and fully lower the pressure board by adjusting handle (B) to setting "400". Open the rear door.
2. Remove the pressure board by gripping the handle provided, and then lift up and out.

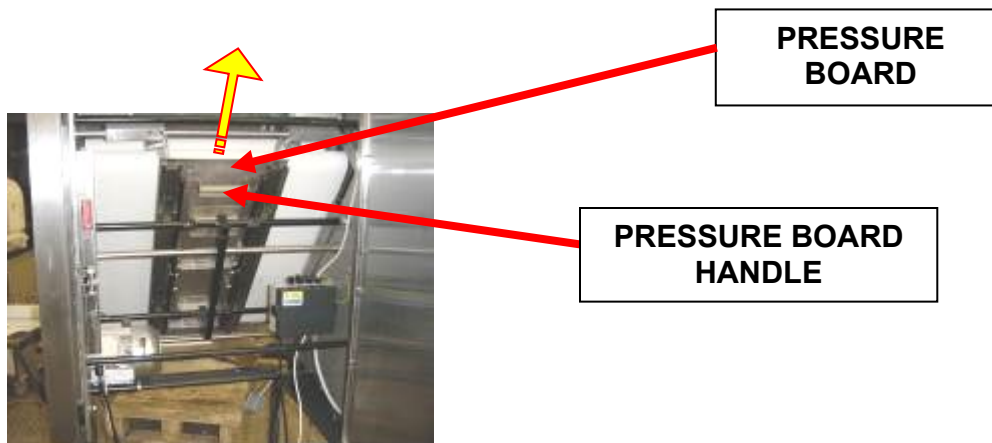

3. Wash dough contact surfaces of the pressure board and side guides with sanitising solution and hot water. Dry with a cloth.
4. Remove any dough from the bottom belt with a plastic scraper.
5. Replace the pressure board, making sure the hooks on the board are fully engaged.

**Close the rear door firmly to make the safety switch connection.**

## OFF TAKE CONVEYOR

This should be scraped clean with a plastic scraper.



## OFF TAKE TRAY

Pull out the off take tray shelf and remove the plastic tray.  
Wash well and dry.  
Replace.

And finally to complete "Daily Cleaning"

- Brush down all external surfaces of the machine including the stand.
- Sweep under machine to remove all debris from the floor.
- Spot clean with dampened cloth, sanitising solution and hot water, paying particular attention to handles, levers and controls.

# WEEKLY CLEANING INSTRUCTIONS

AS DAILY INSTRUCTIONS AND ALSO:

- 1.** *Remove the moulder mains plug from the prover socket, release the brake castors and unclip the positioning locator on the base.*
- 2.** Pull the moulder away from the prover.
- 3.** Wipe the stand with a cloth dampened with sanitising solution and hot water.
- 4.** Scrape and scrub the wheels on the machine.
- 5.** Wipe down all external surfaces with sanitising solution and hot water. Dry with a cloth.

# ROUNDER CLEANING INSTRUCTIONS



**SWITCH OFF AND ISOLATE MACHINE FROM MAINS SUPPLY  
BEFORE COMMENCING CLEANING**

**Every day:**

All dough touching surfaces should be cleaned every day.

Do not use steel scrapers and poisonous chemicals or soap for cleaning purposes.

**Every week:**

Outer sides should be cleaned with sanitising solution and hot water.

Dry with a cloth.

Scrape and scrub wheels clean as needed.

**DANGER:** Cleaning operations should only be carried out with the machine switched off and disconnected from the electric power supplies.



**BEWARE:**

Do not use jets of water to clean.

The control panels and the electric control box should be kept dry.

Do not use solvents, which could damage the paint and synthetic materials.

# 8.0 OPERATION of the breadplant

## THE CONTROLS EXPLAINED

Dough pieces are transferred from the divider via a rounder and a chute to a carrier pocket in the prover.

As dough travels down the chute and into the pocket, an electronic eye is triggered which causes the carriers to move one position ready for the next dough piece.

After two minutes of nothing passing the sensor (divider empty), a flashing light and buzzer alerts the operator.

The prover can then either be run in empty mode, to empty the dough to the moulder, or the divider started and the rounder and prover loading continued.

### MAIN CONTROL PANEL

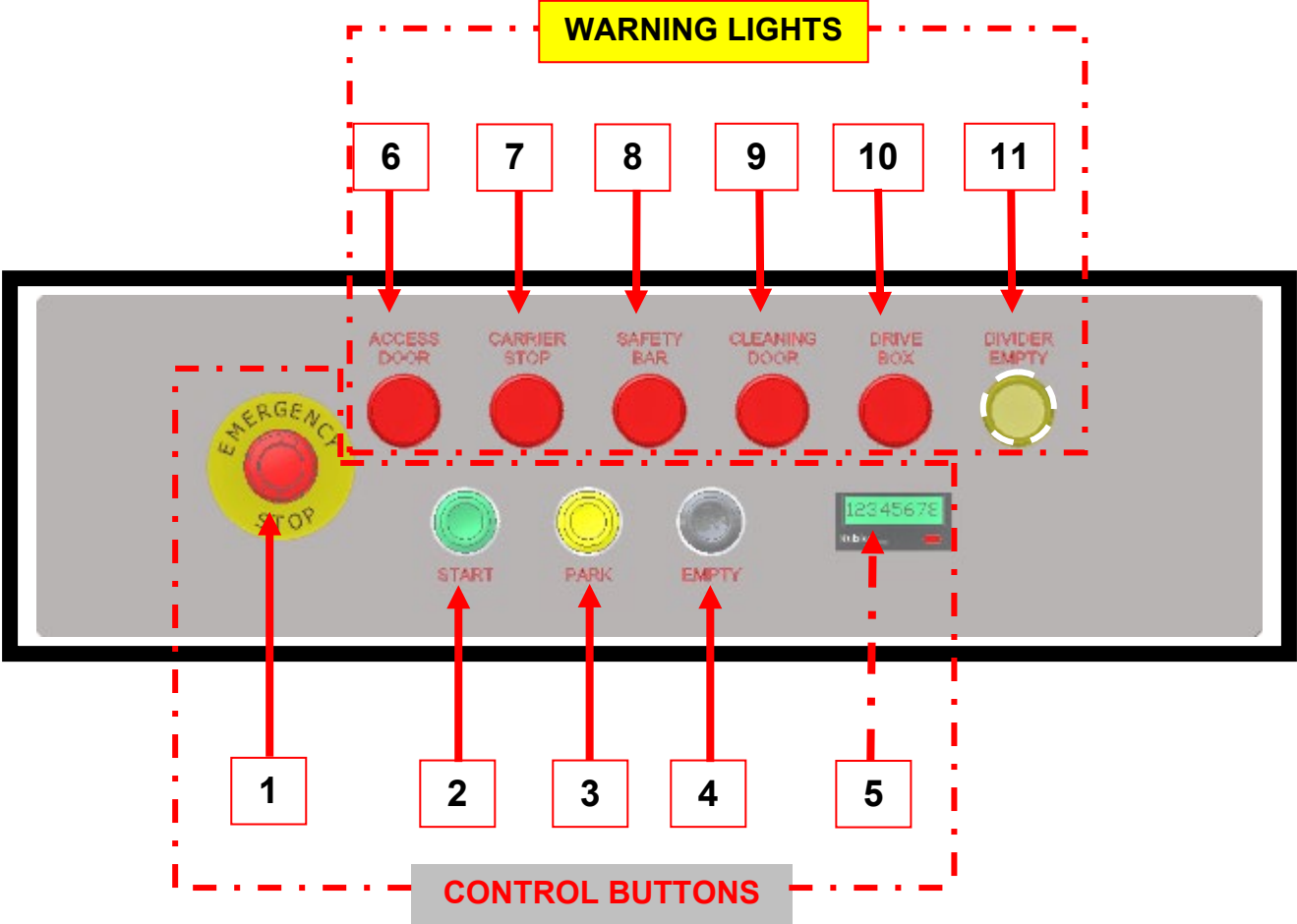

# MAIN PANEL

## **EMERGENCY STOP [1]**

Stops the prover in an emergency.

Release by pushing and turning.

*NOTE. Do not use this to stop the prover except in an emergency, as dough position may cause problems.*

## **START BUTTON [2]**

Starts the prover in auto mode.

(No movement will happen until dough passes the sensor on the chute.)

## **PARK [3]**

Use this to stop the prover carriers in the best operating position.

**Always use this to stop the prover** except in an emergency.

## **EMPTY [4]**

For use when the divider has completed operation and the prover needs to continue moving to feed the moulder.

## **COUNTER [5]**

Counts pieces of dough entering prover from divider.

Press button to reset to 0 before a production run.

*NOTE. Reset is required after power is disrupted or the power is first switched on.*

## **WARNING**

Avoid stopping machine with dough left in the pockets, as after a time it will adhere to the pockets and cause the machine to malfunction.

**ALWAYS CHECK THE POCKETS FOR ADHERING DOUGH AND REMOVE AS SOON AS POSSIBLE. IF IN DOUBT, DO NOT WAIT FOR DAILY CLEANING.**

# WARNING LIGHTS

## ACCESS DOOR [6]

Main overhang cleaning door not positioned correctly.

## CARRIER STOP [7]

Carrier stop switch activated.

Switch off power at main isolator [1].

Check for correct position of carriers in the overhang.

*Dough may have caused a carrier to swing incorrectly at the turnover stage.*

If removing the dough piece cannot rectify the cause, call for maintenance.

## SAFETY BAR [8]

Red safety bar across lower edge of main windows has been activated.

Clear obstruction and restart prover.

## CLEANING DOOR [9]

Front lower cleaning door not positioned correctly.

## DRIVE BOX [10]

Check that the drive box drawer is closed.

The prover will not work unless the drawer is replaced after cleaning.

## DIVIDER EMPTY [11]

After two minutes of nothing passing the sensor (divider is empty), a flashing light and buzzer starts to alert the operator.

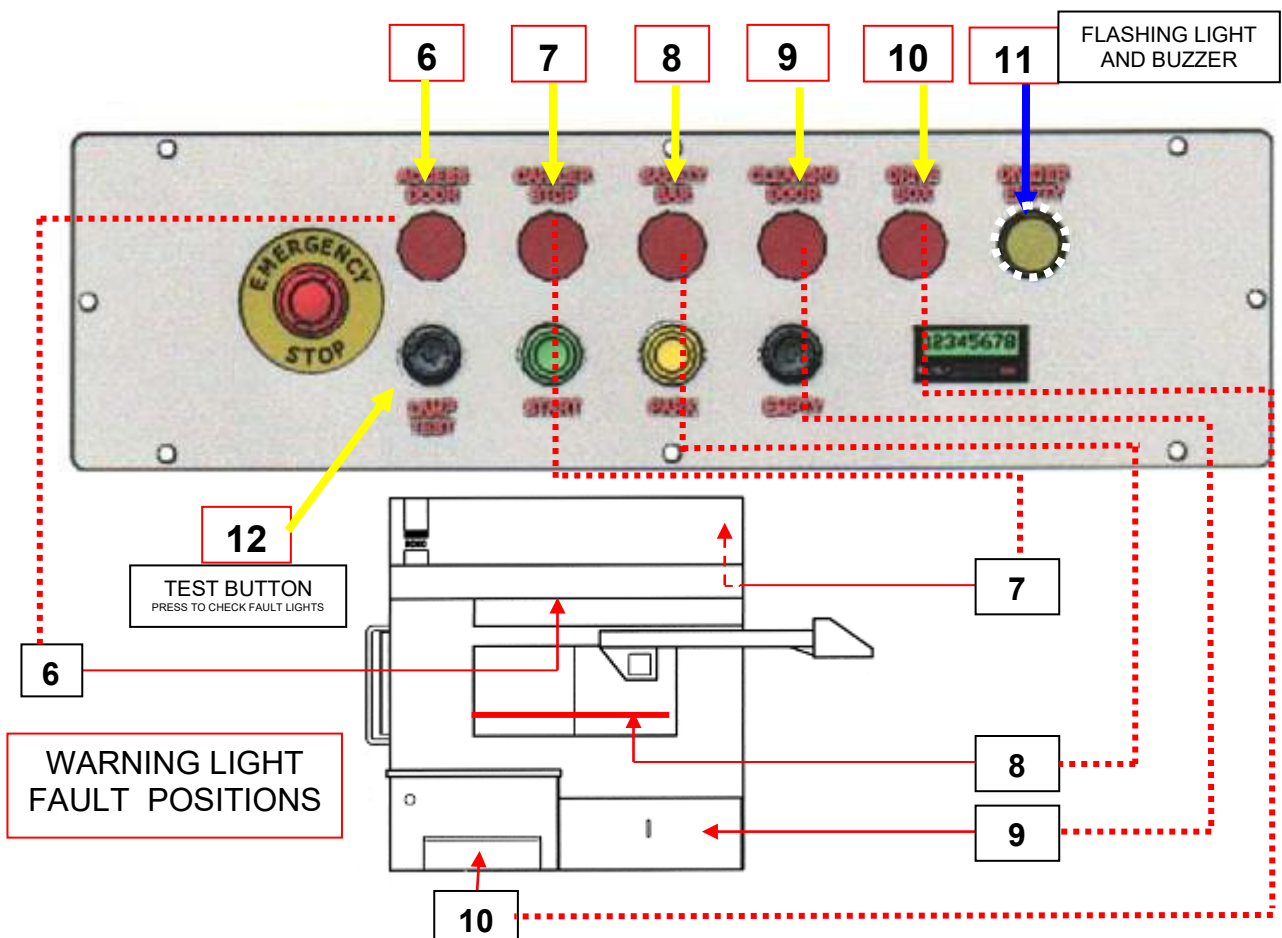



# MOULDER INFEED CONVEYOR CURLING CHAIN



Position the curling chain lever to the required position  
Either “loaf” or “French” as shown below.



# **FLOUR DUSTER OPERATION**

TO ENSURE AN EVEN FLOW, ONLY USE CLEAN, DRY FLOUR.



DUSTER LOCATION

1

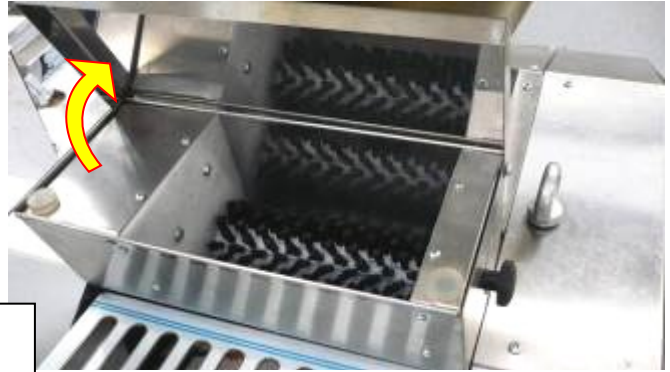

OPEN LID AND FILL WITH DRY FLOUR,  
THEN CLOSE THE LID

2



TURN ON POWER WHEN REQUIRED

3



ADJUST THE FLOW BY LOOSENING THE  
BLACK KNOB AND MOVING TO THE  
REQUIRED POSITION. RETIGHTEN KNOB.

## How to operate the FUSION BREADPLANT

1. Ensure the prover power is connected and main isolator is on.
2. Ensure that the divider is in position and plugged into the prover.
3. Ensure the moulder is in position and plugged into the prover. Adjust the moulding settings for the product required.
4. Set the moulder infeed conveyor curling chain position.(Loaf or French).
5. Press the “start” button [2] on the prover and the reset button on the counter. The prover will now be ready to receive dough.
6. Load the divider hopper with dough.
7. Start the divider (green button on divider) and adjust weights as instructed in the divider section of this manual.
8. When satisfied with the dough weights, allow the dough to enter the prover. The prover will move to the next carrier every time it senses a dough piece.
9. If the prover does not sense a dough piece for 2 minutes, the “Divider Empty” light will flash and a sounder will be heard.
10. If the divider is empty or the light is flashing, push the empty button [4] and the prover will keep moving to prove the dough and empty to the moulder.
11. When the dough reaches the moulder, the moulder will start and the moulded dough pieces should be collected and placed on trays or in tins as required.
12. If the prover needs to be stopped during operation, use the yellow “park” button [3], not the emergency stop button. This will ensure that the prover is stopped in a position that will not allow dough pieces to jam the system. The moulder and prover offtake conveyor will continue to run for 30 seconds to ensure the dough path is cleared.

### **NOTE**

**THE EMERGENCY STOP ON THE DIVIDER WILL STOP THE DIVIDER.**

**THE EMERGENCY STOP ON THE MOULDER WILL STOP THE MOULDER.**

**THE EMERGENCY STOP ON THE ROUNDER WILL STOP THE ROUNDER.**

**THE EMERGENCY STOP ON THE PROVER WILL STOP ALL MACHINES.**

If emergency stop switches are activated on the divider (opening hopper guard etc.), the stop reset button on the divider control panel must be pressed. If the pressure board is opened (for cleaning etc.), then the emergency stop switch must be pressed, twisted to release and then the reset switch pressed.

**NOTE**

This section may not be correct for your model. Please contact MONO before using.

# **FUSION<sup>PRO</sup> PROVER**

## **9.0 ELECTRICAL INFORMATION SECTION**



IF IN ANY DOUBT - ASK

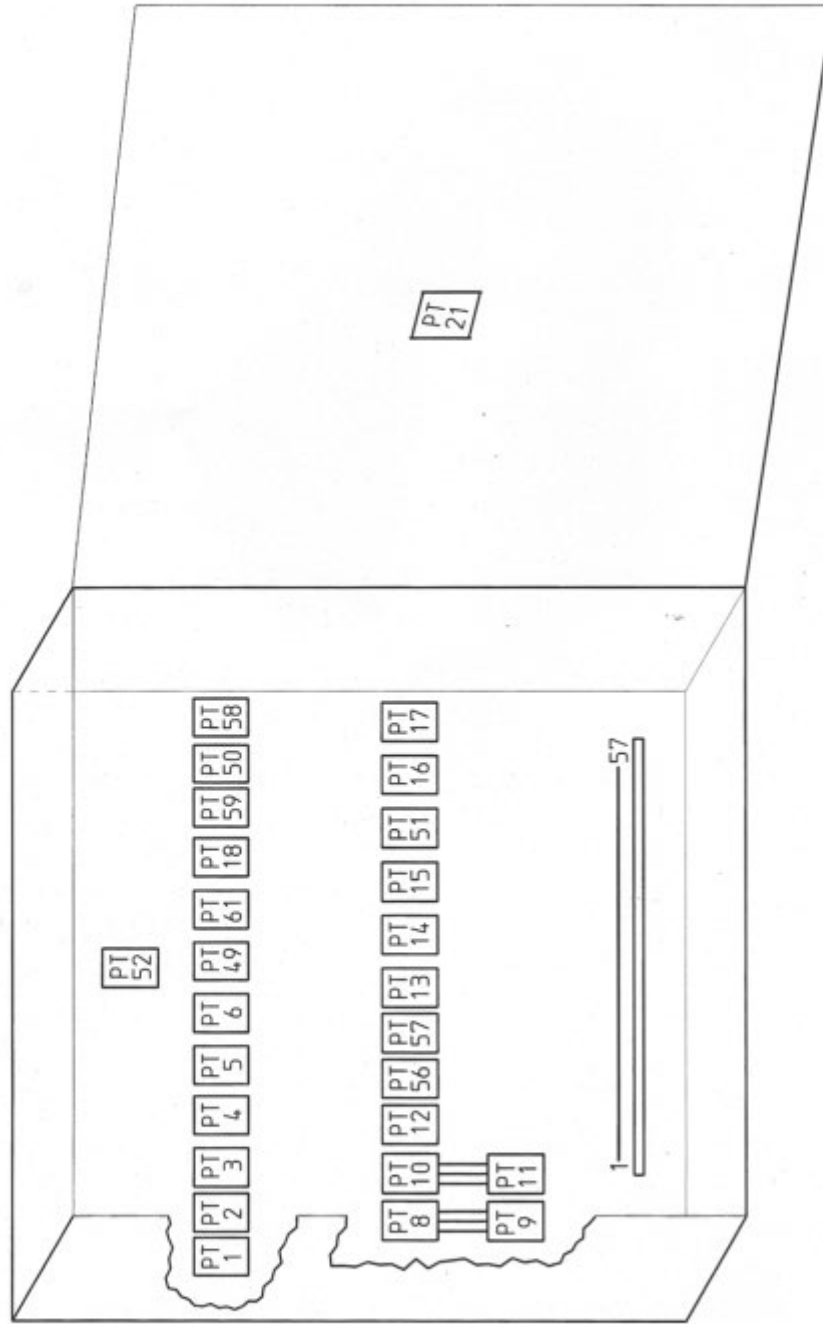

REV	SIG	DATE	REVISION	ECH NO.
			TITLE: FUSION PRO BREAD PLANT	
			PARK N RIDE PROVER	
			MAIN CONTROL PANEL COMPONENT	
			LAYOUT (WITH CONVEYOR AND ROUNDER)	
			DRAWN: ELECTRICALLY APPROVED BY:-	
			RAC/JC	
			DATE: 02-13	
			DRAWING NO. M036E25-4.1300	
			REV: ---	

**MONO EQUIPMENT**  
 QUEENSWAY  
 SWANSEA WEST IND PARK  
 SWANSEA,  
 SA5 4EB.  
 TEL: (01792) 561234  
 FAX: (01792) 561016

ELECTRICAL SPECIFICATIONS:-

COPYRIGHT © 1998 - THIS DESIGN/DRAWING IS THE PROPERTY OF MONO EQUIPMENT LTD. AND MUST NOT BE REPRODUCED, COPIED, NOR ITS CONTENTS DIVULGED WITHOUT PRIOR WRITTEN PERMISSION.

<u>DRAWING</u> <u>PT-Ref</u>	<u>DESCRIPTION</u>	<u>MONO</u> <u>PART NUMBER</u>	<u>DRAWING</u> <u>PT-Ref</u>	<u>DESCRIPTION</u>	<u>MONO</u> <u>PART NUMBER</u>
PT-1	MAIN MOTOR M.C.B.	8872-22-052	PT-26	DRIVE BOX INDICATOR LIGHT	8723-43-002
PT-2	CONVEYOR MOTOR M.C.B.	8872-22-051	PT-27	CLEANING DOOR INDICATOR LIGHT	8723-43-002
PT-3	DIVIDER SOCKET M.C.B.	8872-22-054	PT-28	SAFETY BAR INDICATOR LIGHT	8723-43-002
PT-4	MOULDER SOCKET M.C.B.	8872-22-052			
PT-5	ROUNDER SOCKET M.C.B.	8872-22-054			
PT-6	CONTROL CIRCUIT M.C.B.	8872-22-001			
PT-8	MAIN MOTOR CONTACTOR	8801-08-033			
PT-9	MAIN MOTOR THERMAL OVERLOAD	8801-01-043			
PT-10	CONVEYOR FORWARD CONTACTOR	8801-08-033			
PT-11	CONVEYOR MOTOR THERMAL OVERLOAD	8801-01-047			
PT-12	DIVIDER SOCKET CONTACTOR	8801-08-033			
PT-13a	STOP/START RELAY	8723-37-006			
PT-13b	STOP/START RELAY BASE	8723-36-001			
PT-14a	DELAYED STOP RELAY	8723-37-006			
PT-14b	DELAYED STOP RELAY BASE	8723-36-001			
PT-15a	PHOTOCELL RELAY	8723-37-006			
PT-15b	PHOTOCELL RELAY BASE	8723-36-001			
PT-16a	AUTO RELAY N'1	8723-37-009			
PT-16b	AUTO RELAY N'1 BASE	8723-36-002			
PT-17a	AUTO RELAY N'2	8723-37-009			
PT-17b	AUTO RELAY N'2 BASE	8723-36-002			
PT-18	XENON LIGHT DELAY TIMER	8842-34-003			
PT-19	PHOTOCELL UNIT	8801-99-020			
PT-19A	PHOTOCELL REFLECTOR	8801-99-017			
PT-21a	EMERGENCY STOP BUTTON	8801-12-015			
PT-21b	CONTACT BLOCK N/C	8801-14-001			
PT-21c	*EMERGENCY STOP* BUTTON LEGEND	8801-15-003			
PT-22	START BUTTON	8801-12-002			
PT-22A	START BUTTON N/C CONTACT BLOCK	8801-14-001			
PT-22B	START BUTTON N/O CONTACT BLOCK	8801-14-004			

REV	SIG	DATE	REVISION	ECN NO.
			FUSION PRO BREAD PLANT	
 MONO EQUIPMENT QUEENSWAY SWANSEA WEST IND PARK SWANSEA, SA5 4EB. TEL: (01792) 561234 FAX: (01792) 561016 Email: engineering@monoequip.com			TITLE: FUSION PRO BREAD PLANT COMPONENT LIST PARK n RIDE PROVER	
ELECTRICAL SPECIFICATIONS:-			DRAWN:	ELECTRICALLY APPROVED BY:-
			RAC/JC	
			DATE:	
			02-13	
			DRAWING NO.	SHT 1 OF 2
			M036E25-41500	REV: ---

COPYRIGHT © 1998 - THIS DESIGN/DRAWING IS THE PROPERTY OF MONO EQUIPMENT LTD. AND MUST NOT BE REPRODUCED, COPIED, AND ITS CONTENTS DIVULGED WITHOUT PRIOR WRITTEN PERMISSION.

<u>DRAWING</u> PT-Ref	<u>DESCRIPTION</u>	<u>MONO</u> PART NUMBER	<u>DRAWING</u> PT-Ref	<u>DESCRIPTION</u>	<u>MONO</u> PART NUMBER
PT-29	CARRIER STOP INDICATOR LIGHT	8723-43-002	PT-46	DIVIDER SOCKET	8883-06-007
PT-30	ACCESS DOOR INDICATOR LIGHT	8723-43-002	PT-47	MOULDER SOCKET	8883-06-007
PT-31	MAIN MOTOR (up to March 2011)	8912-74-008	PT-48	ROUNDER SOCKET	8883-06-007
PT-31	MAIN MOTOR (after March 2011)	8912-74-032	PT-49	SINGLE PHASE SOCKET M.C.B.	8872-22-004
PT-31	MAIN MOTOR (after Oct 2012)	8912-74-034	PT-50	AUTO DELAY TIMER	8842-34-003
PT-33	DRIVE BOX SAFETY SWITCH	8818-07-010	PT-51	INDEX RELAY	8723-37-006
PT-34	SINGLE PHASE SOCKET OUTLET	8835-06-001	PT-52	MAIN PANEL DOOR INTERLOCK SWITCH	8723-07-001
PT-35	INDEX SWITCH	8801-11-001	PT-56	MOULDER CONTACTOR	8801-08-033
PT-36	CLEANING DOOR SAFETY SWITCH	8818-07-010	PT-57	ROUNDER CONTACTOR	8801-08-033
PT-37	SAFETY BAR SAFETY SWITCH	8801-11-001	PT-58	START RELAY	8723-37-009
PT-38	AUDIO/VISUAL ALARM	8723-92-004	PT-58B	START RELAY BASE	8723-36-002
PT-39a	CARRIER STOP SAFETY SWITCH BODY	8801-11-005	PT-59	CONVEYOR/MOULDER RUN ON TIMER	8842-34-003
PT-39b	CARRIER STOP SWITCH ACTUATOR	8801-45-001	PT-60	COUNTER	8842-34-011
PT-40a	REMOTE EMERGENCY STOP BUTTON	8801-12-015	PT-61	RUN ON PULSE TIMER	8842-34-003
PT-40b	CONTACT BLOCK N/C	8801-14-001	PT-62A	TEST LAMP BUTTON	8801-12-021
PT-41a	REMOTE DELAYED STOP BUTTON	8801-12-001	PT-62B	CONTACT BLOCK	8801-14-005
PT-41b	CONTACT BLOCK N/C	8801-14-001			
PT-41c	CONTACT BLOCK N/O	8801-14-002			
PT-42a	EMPTY BUTTON	8801-12-021			
PT-42b	CONTACT BLOCK N/C	8801-14-001			
PT-44	CONVEYOR MOTOR	8912-74-030			
PT-45	ACCESS DOOR SAFETY SWITCH	8818-07-010			

REV	SIG	DATE	REVISION	ECN NO.
			TITLE:	
 MONO EQUIPMENT QUEENSWAY SWANSEA WEST IND PARK SWANSEA, SA5 4EB. TEL: (01782) 561234 FAX: (01782) 561016 Email: <a href="mailto:engineering@monoequip.com">engineering@monoequip.com</a>			FUSION PRO BREAD PLANT	
ELECTRICAL SPECIFICATIONS:-			COMPONENT LIST	
			PARK n RIDE PROVER	
			DRAWN:	
			RAC / JC	
			DATE:	
			02-13	
			DRAWING NO.	
			SHT 2 OF 2	
			REV:	
			M036E25-41500	---

COPYRIGHT © 1998 - THIS DESIGN/DRAWING IS THE PROPERTY OF MONO EQUIPMENT LTD. AND MUST NOT BE REPRODUCED, COPIED, NOR ITS CONTENTS DIVULGED WITHOUT PRIOR WRITTEN PERMISSION.





IF IN ANY DOUBT - ASK

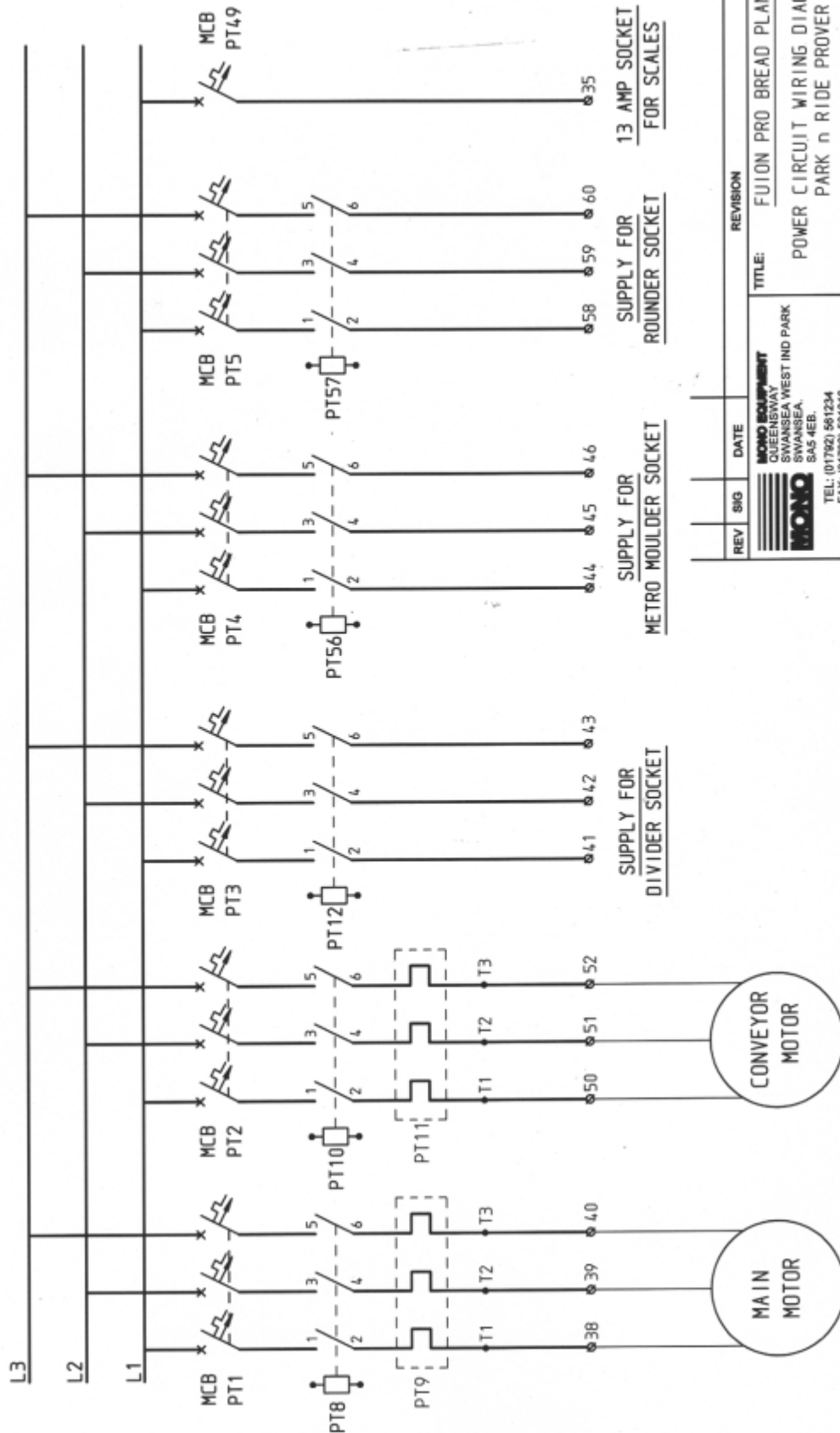

REV	SIG	DATE	REVISION	ECN NO.
			FUJION PRO BREAD PLANT	
 MONO EQUIPMENT QUEENSWAY SWANSEA WEST IND PARK SWANSEA, SAS 4EB. TEL: (01792) 581234 FAX: (01792) 591018			TITLE: FUJION PRO BREAD PLANT POWER CIRCUIT WIRING DIAGRAM PARK n RIDE PROVER	
ELECTRICAL SPECIFICATIONS:-			DRAWN: RAC/JC	ELECTRICALLY APPROVED BY:-
			DATE: 02-08	DRAWING NO. M036E25-41200
				REV: —

COPYRIGHT © 1998 - THIS DESIGN/DRAWING IS THE PROPERTY OF MONO EQUIPMENT LTD. AND MUST NOT BE REPRODUCED, COPIED, NOR ITS CONTENTS DIVULGED WITHOUT PRIOR WRITTEN PERMISSION.

REAR VIEW OF PANEL

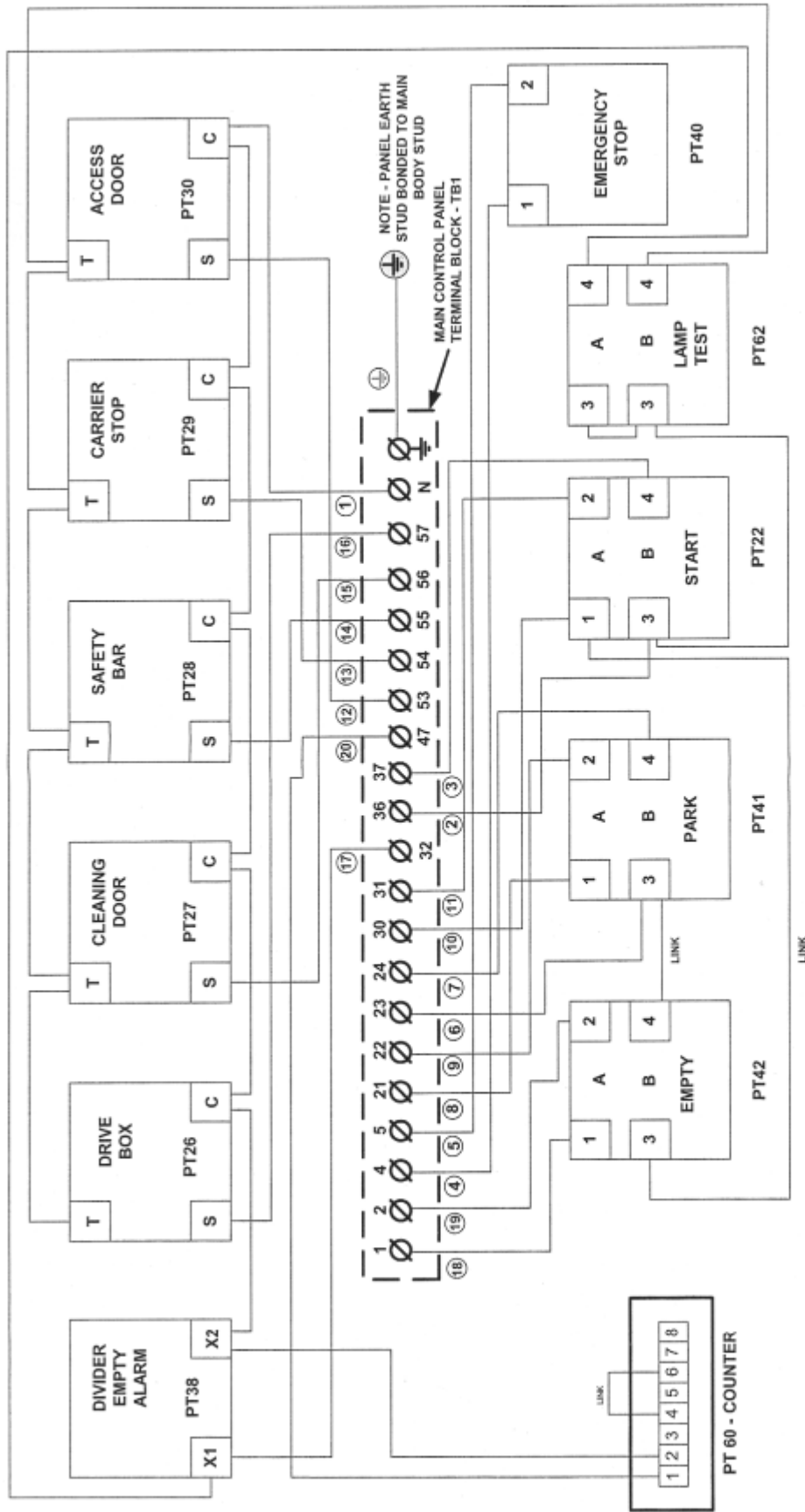

<p>MONO ELECTRICITY                  1000 EAST WALK                  WARRIMOO NSW 2380                  TEL: (077) 8124                  FAX: (077) 8219</p>	TITLE TESCO FUSION 2 REMOTE CONTROL PANEL WIRING WITH LAMP TEST BUTTON	
	DRAWN ADT	ELECTRICALLY APPROVED BY: ADT
ELECTRICAL SPECIFICATIONS: 230 VOLT CONTROL CIRCUIT		DATE 13/1/10
DRAWING NO. M036E25-31100		REV. B

NOTE - ① - ⑤ DENOTES MULTICORE CABLE CORE NUMBERS  
 CABLE - 21 CORE 0.5MM<sup>2</sup> - B843-57-020  
 CABLE LENGTH - 4 M FROM CABLE ENTRY GLAND

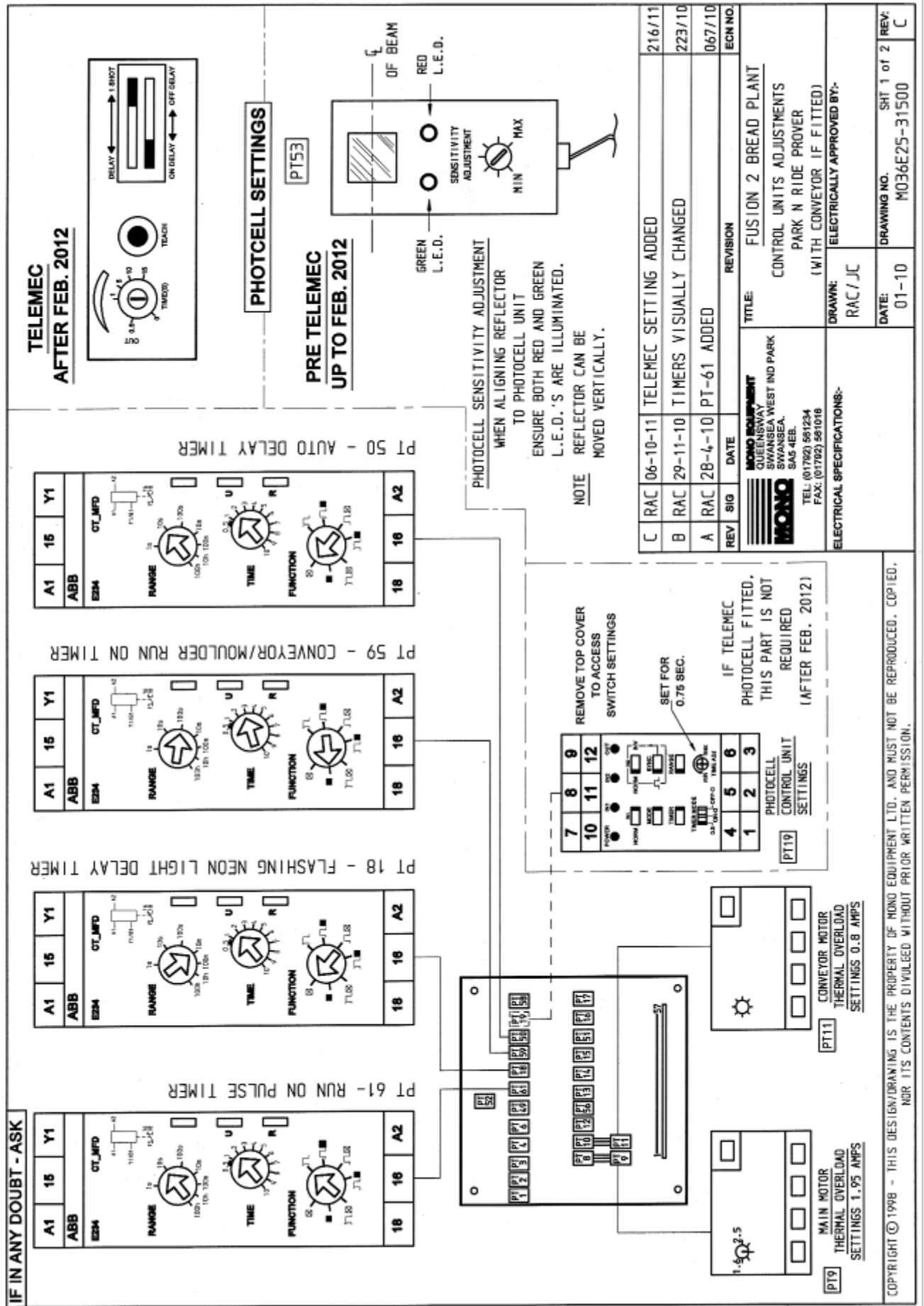

IF IN ANY DOUBT - ASK

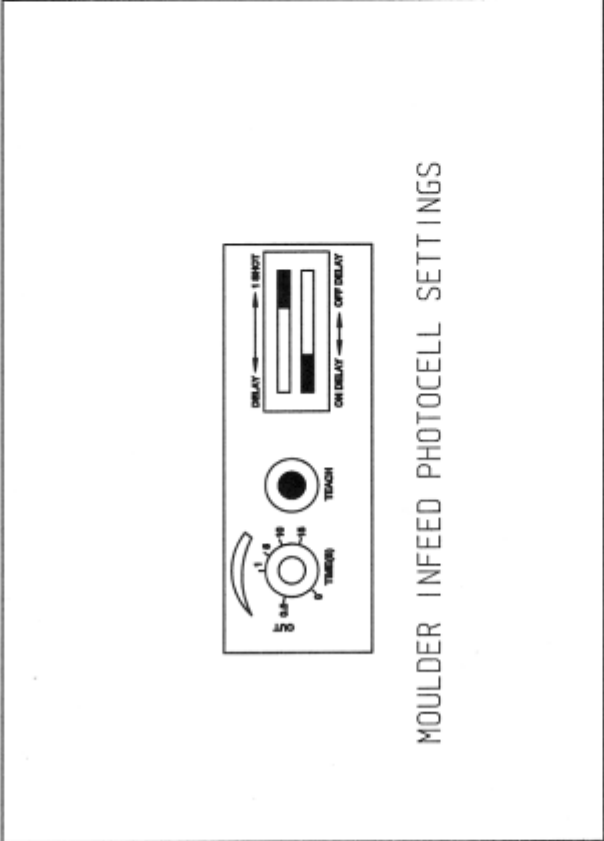

MOULDER INFEEED PHOTOCELL SETTINGS

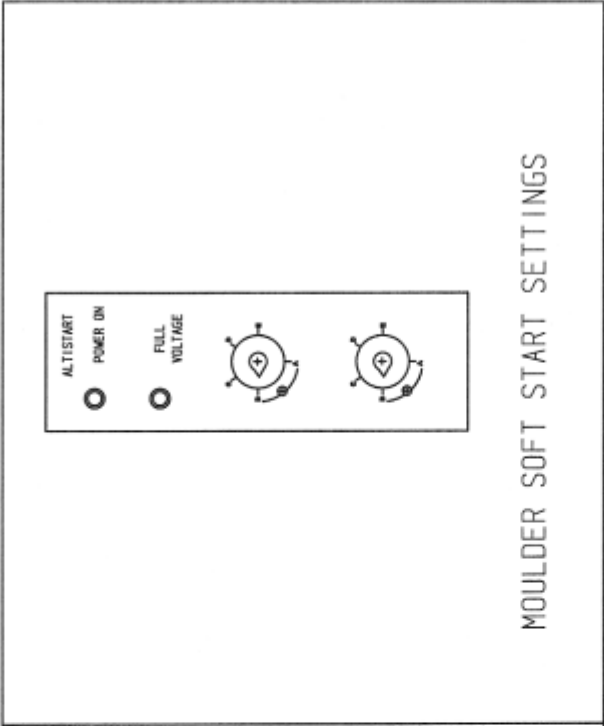

MOULDER SOFT START SETTINGS

REV	SIG	DATE	REVISION	ECH NO.
		<b>TITLE:</b> FUSION 2 BREAD PLANT CONTROL UNITS ADJUSTMENTS PARK N RIDE PROVER (WITH CONVEYOR)		
MONO EQUIPMENT QUEENSWAY SWANSEA WEST IND PARK SWANSEA, SA5 4EB. TEL: (01792) 881234 FAX: (01782) 061010		<b>DRAWN:</b> RAC / JC <b>DATE:</b> 01-10 <b>DRAWING NO.:</b> M036E25-31500 <b>SHT 2 of 2</b>		
<b>ELECTRICAL SPECIFICATIONS:-</b>		ELECTRICALLY APPROVED BY:-		

COPYRIGHT © 1998 - THIS DESIGN/DRAWING IS THE PROPERTY OF MONO EQUIPMENT LTD. AND MUST NOT BE REPRODUCED, COPIED, NOR ITS CONTENTS DIVULGED WITHOUT PRIOR WRITTEN PERMISSION.

# 10.0 Maintenance of the breadplant

---



- WARNING**
- This appliance must be maintained at regular intervals. The frequency of maintenance will depend upon your specific use and location. The maximum service interval should be 12 months.
  - Service and maintenance should only be undertaken by suitably qualified, trained, and competent engineers.
  - You must immediately report any damage or defect arising with the appliance.
  - Unsafe equipment is dangerous. Do not use the appliance. Isolate the power supply and contact MONO or your appointed service agent.
- 



- WARNING**
- Isolate the machine from the mains supply before attempting any maintenance operations.
-

# SECTION 2

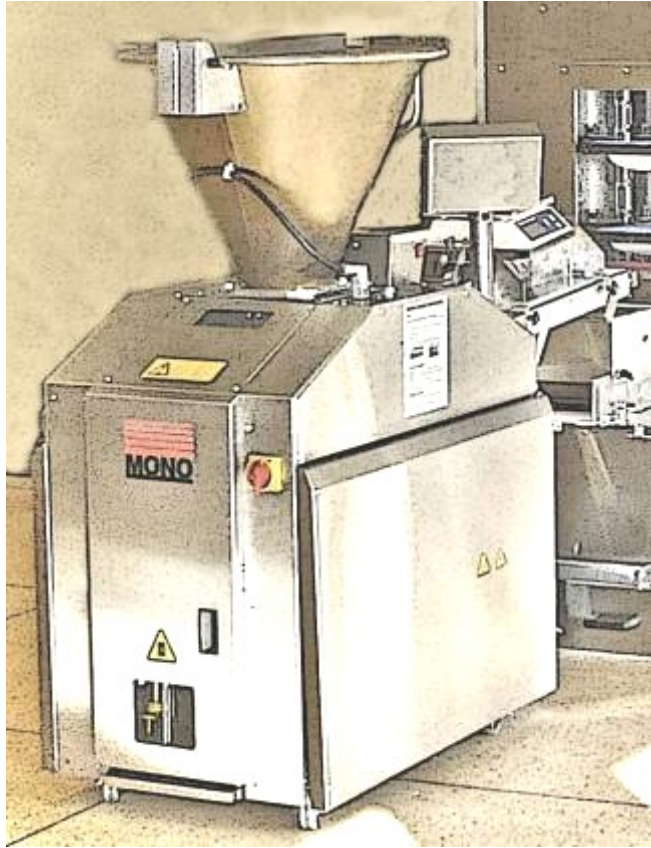

FULL OPERATING AND MAINTENANCE  
MANUAL  
FOR THE  
**FUSION BREADPLANT DIVIDER**

**DIVIDER** FULL INSTRUCTIONS

# IMPORTANT NOTES

- ❑ **FAILURE TO KEEP TO THE CLEANING AND MAINTENANCE INSTRUCTIONS DETAILED IN THIS MANUAL COULD AFFECT THE WARRANTY and SAFETY OF THIS MACHINE**

**○ WARNING! --- DIVIDER OIL**  
**NOT USE ORDINARY VEGETABLE OIL FROM SHOP SHELVES, IN THE DIVIDER.**

*THIS WILL FORM A GUM-LIKE RESIDUE,  
CAUSING STICKING AND POSSIBLE DAMAGE TO THE MACHINE.*

MONO RECOMMENDS THE USE OF “**CRODA SUPER WUNDROL**”  
(AVAILABLE FROM MONO. PART NUMBER “**A900-25-272**”)

# CONTENTS – DOUGH DIVIDER

- 1.0 INTRODUCTION ..... 57
- 2.0 GENERAL DIMENSIONS..... 58
- 3.0 SPECIFICATIONS..... 58
- 4.0 SAFETY..... 59
- 5.0 INSTALLATION..... 60
- 6.0 ISOLATION ..... 62
- 7.0 CLEANING INSTRUCTIONS ..... 63
  - Daily.....63
  - Weekly .....67
- 8.0 OPERATING ..... 68
- 9.0 MAINTENANCE ..... 71
- 10.0 TROUBLESHOOTING ..... 73
- 11.0 SPARES AND SERVICE..... 80

---

**FOR SERVICE AND SPARES RING: 01792 564044**

---

- 12.0 ELECTRICAL INFORMATION SECTION ..... 81



# 1.0 INTRODUCTION

IF YOU ENCOUNTER ANY ISSUE WITH THIS EQUIPMENT THAT YOU HAVE NOT BEEN TRAINED FOR, YOU MUST CONTACT YOUR INSTORE TECHNICIAN OR BAKERY MANAGER.

**THE MONO DIVIDER is accurate, reliable and compact.**

- ❑ It has a large capacity hopper, simple controls and adjustments.
- ❑ The in-line discharge gives a very compact machine.
- ❑ The dough divider has the capacity to accurately scale dough pieces, Between 8oz (250g) and 36oz (1000g).

## THE DIVIDING PROCESS

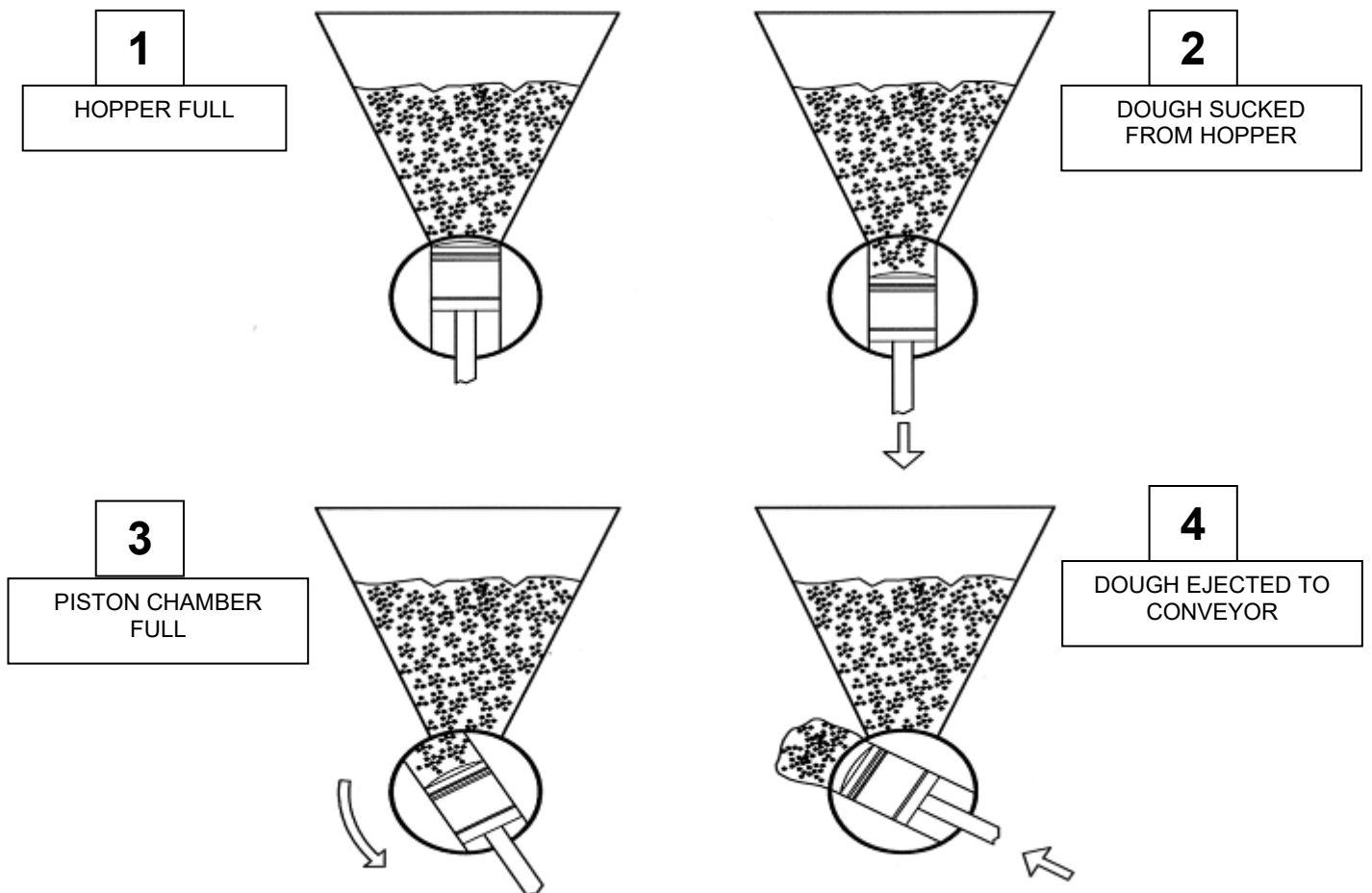

**NOTE**  
THE DIVIDER WORKS ON VOLUME NOT WEIGHT.

## 2.0 GENERAL DIMENSIONS

---

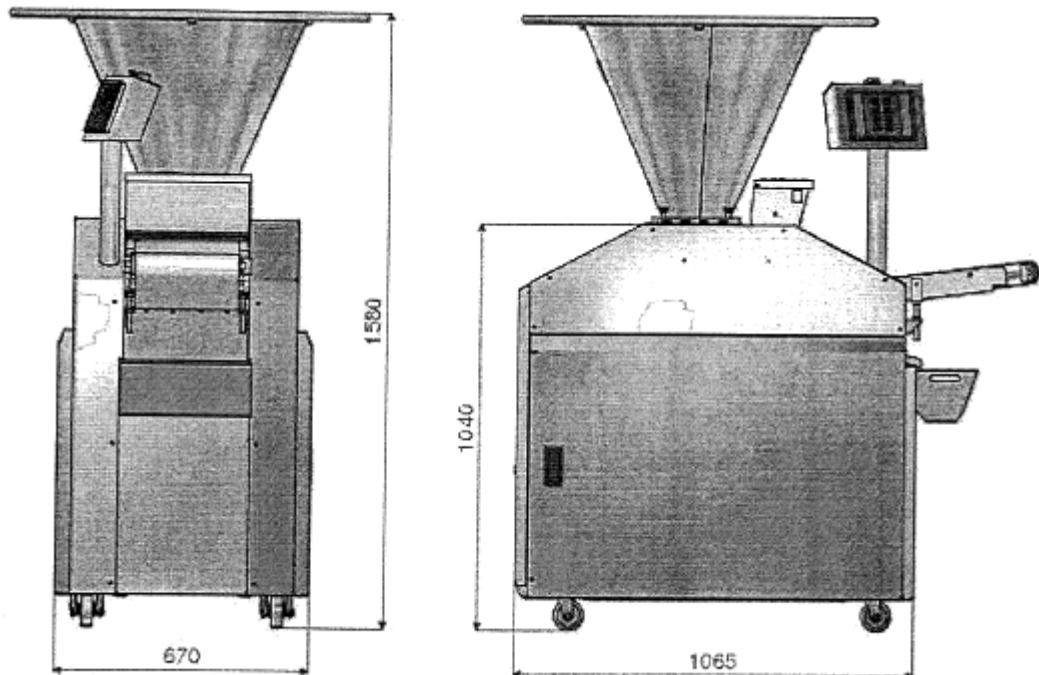

**Height:** 1580mm.

**Depth:** 1065mm. (inc. conveyor 1400mm)

**Width:** 670mm.

## 3.0 SPECIFICATIONS

---

**Total power:** 3.2kW, three phase + N + E, 415v /50Hz

**Capacity:** Accurately scaled dough pieces,  
between 250g and 1000g (8oz - 36oz).

**Weight:** 500kg.

**Noise Level:** Less than 85dB.

## 4.0 SAFETY



- 1 **Never use a machine in a faulty condition** and always report any damage.
- 2 **Only trained engineers may remove any part** that requires a tool to do so.
- 3 **People undergoing training on the machine must be under direct supervision** of a fully trained person.
- 4 **Use of the machine can prove dangerous** if:
  - ❑ The machine is operated by untrained or unskilled staff
  - ❑ The machine is not used for its intended purpose
  - ❑ The machine is not operated correctly



- 5 **Always ensure hands are dry before touching any electrical appliance** (Including cable, switches and plugs).
- 6 **Do not operate the machine with any panels or guards removed.**
  - ❑ *All safety devices applied to the machine during manufacture and the operating instructions in this manual are required to operate this machine safely. The owner and the operator are responsible for operating this machine safely.*



- ❑ ***DO NOT TRY TO DISABLE ANY SAFETY DEVICES, THEY ARE FITTED FOR YOUR SAFETY.***

- 7 **NEVER** move machinery by pulling on the power cords or cables.
- 8 **No loose clothing or jewellery** should be worn while operating the machine
- 9 **The bakery manager or the bakery supervisor must carry out daily safety checks** on the machine.
- 10 **No one under the age of 16 may operate** this machine.
- 11 **No-one under the age of 18 may clean** this machine under any circumstances.



- 12 **DO NOT STAND ON ANYTHING TO LOAD THE DIVIDER HOPPER.**



**WARNING:**

NEVER LEAVE MACHINE WITH DOUGH IN AS PRESSURES BUILD UP AS THE DOUGH PROVES.



**ALL CLEANING AND MAINTENANCE OPERATIONS MUST BE MADE WITH THE DIVIDER DISCONNECTED FROM THE POWER SUPPLY.**

## 5.0 INSTALLATION

---



### **DO NOT ATTEMPT TO LIFT THE DIVIDER BY HUMAN FORCE (LIFTING)**

- ❑ Use of a **forklift or crane** is recommended for lifting, or the machine can be pushed into position on the castors provided.
- ❑ **To lift with a forklift** - the machine must be secured to a pallet.
- ❑ **To lift with a crane** - lifting eyes are provided .



**LIFTING EYES**

***Check that the power rating on the serial number plate matches the supply that the machine is to be connected to.***

- ❑ Connect the electrical cable to the socket on the prover drive box front or power socket on the wall if not being used as part of a bread plant.
- ❑ Check machine after installation to ensure the belt moves in the correct direction indicated (see arrow in photo below).

*(If wrong - swap positions of any two of the three phase carrying wires in the plug.  
With a plant this should be factory set and not need to be done)*



- ❑ Fill oil tank to 2/3 level, with your company recommended food safe oil.

○ **WARNING!**

**DO NOT USE ORDINARY VEGETABLE OIL FROM SHOP SHELVES, IN THE DIVIDER**  
*THIS WILL FORM A GUM-LIKE RESIDUE,*  
 CAUSING STICKING AND POSSIBLE DAMAGE TO THE MACHINE.  
 MONO RECOMMENDS THE USE OF “CRODA SUPER WUNDROL”  
 (AVAILABLE FROM MONO. PART NUMBER “A900-25-272”)

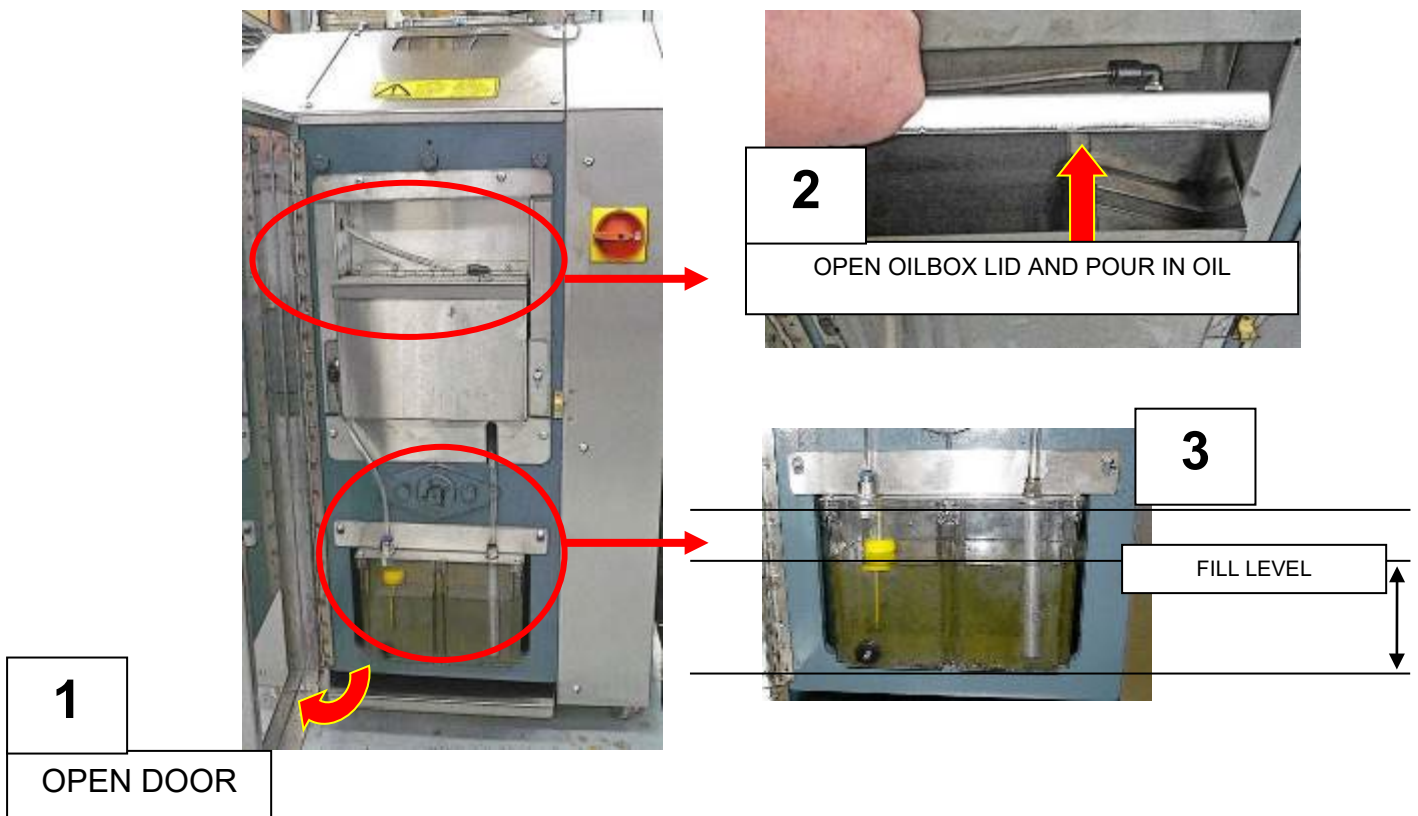

# 6.0 ISOLATION



TO STOP THE DOUGH DIVIDER IN AN EMERGENCY,  
Switch off at the PLANT MAIN ISOLATOR or use plant EMERGENCY BUTTON

OR

**DIVIDER MAIN ISOLATOR**



**The DIVIDER EMERGENCY STOP BUTTON.**



**EMERGENCY STOP BUTTON  
(TWIST TO RELEASE)**



# 7.0 CLEANING INSTRUCTIONS

## DAILY



NOTE:

**ISOLATE MACHINE FROM DIVIDER SUPPLY BEFORE CLEANING.**

- CLEANING SHOULD ONLY BE CARRIED OUT BY FULLY TRAINED PERSONNEL
- DO NOT USE A HIGH PRESSURE WASHER
- DO NOT USE SOLVENTS OF ANY KIND
- KEEP CLEANING FLUIDS AWAY FROM ELECTRICAL SWITCHES

1 Remove the dough residue from interior of the hopper.  
(Only use **plastic scraper**)

2 Smear interior of the hopper with divider oil.

4 Check oil level is correct. (see next page).

Then run the machine for a minute, using on/off buttons.  
(*This will stop the machine from seizing up by coating the drum with oil*)

**NOTE:**

**THE ABOVE STEPS MUST BE FOLLOWED DAILY,  
OTHERWISE IT WILL LEAD TO THE BUILD UP OF STARCH  
AND SEIZURE OF THE MACHINE.**

# OIL LEVEL CHECKING

- Fill oil tank to 2/3 level, with your company recommended food safe oil.

**○ WARNING!**  
**DO NOT USE ORDINARY VEGETABLE OIL FROM SHOP SHELVES, IN THE DIVIDER**  
*THIS WILL FORM A GUM-LIKE RESIDUE,  
CAUSING STICKING AND POSSIBLE DAMAGE TO THE MACHINE.*

MONO RECOMMENDS THE USE OF “CRODA SUPER WUNDROL”  
(AVAILABLE FROM MONO. PART NUMBER “A900-25-272”)

2

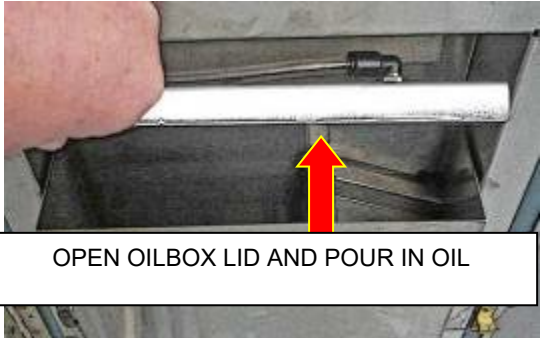

1  
OPEN DOOR





3  
FILL LEVEL



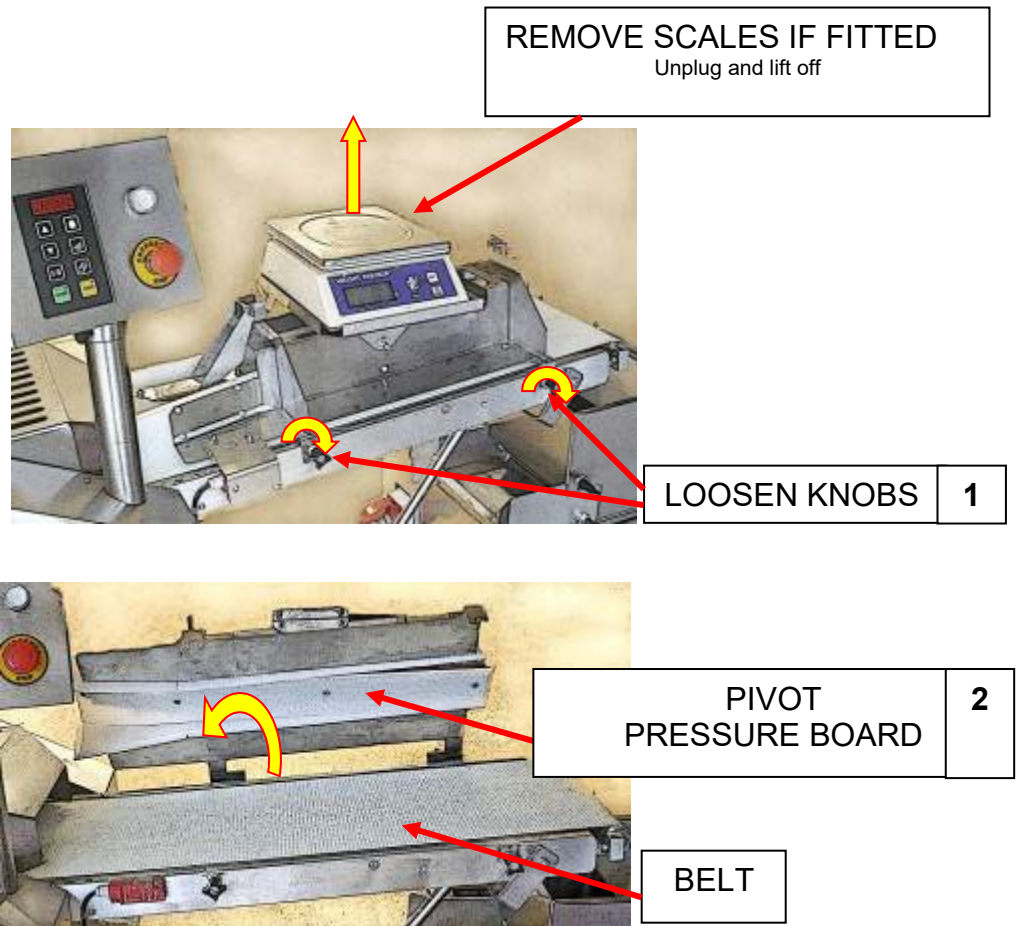

## ❑ OFF TAKE CLEANING



- 1 Unplug and remove the scales.
- 2 Loosen the two black knobs on the side of the pressure board.
- 3  Pivot the pressure board away from you.  
Help may be required to hold the pressure board while cleaning takes place.
- 4 Remove any dough residue and brush exposed parts.
- 5 Scrape and wipe down the belt. (Only use **plastic scraper**).
- 6 Remove any dough residue from the conveyor metal work and belt surface.
- 7 Lower the pressure board and tighten the two black knobs on the side of the pressure board.
- 8 Replace and plug in the scales.

## □ EXTERNAL CLEANING

- 1 Brush off any flour residue and scrape as necessary. (Only use **plastic scraper**)
- 2 Brush off loosened dough.
- 3 Make up sterilising solution and hot water.
- 4 Clean the exterior of the divider as necessary, working from top to bottom.
- 5 Dry with disposable tissue.

## □ UNDER CONVEYOR COLLECTION BOX

- 1 Brush the chute debris into the collection box.

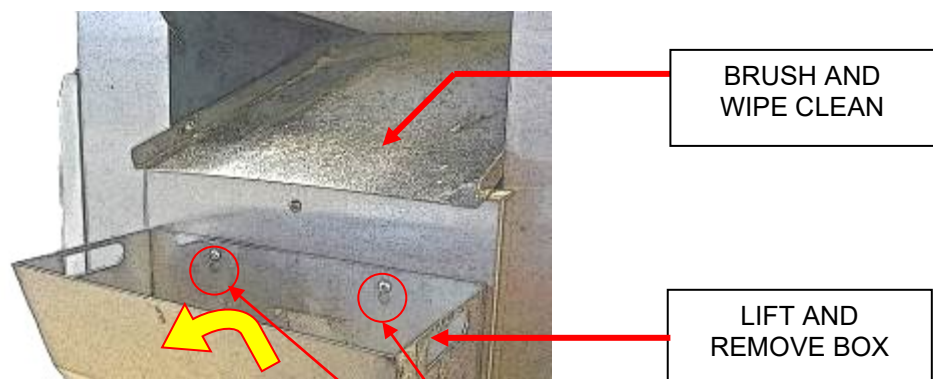

- 2 Lift and remove the collection box and clean.
- 3 Replace the collection box, making sure it is pushed right down on locating screws.

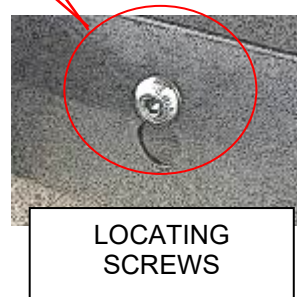

## **WEEKLY**

**NOTE:**

CLEANING SHOULD ONLY BE CARRIED OUT BY FULLY TRAINED PERSONNEL



**WARNING:  
ISOLATE MACHINE FROM MAINS SUPPLY**

1. Scrub wheels with a small nylon cleaning brush or scouring pad and hot water sterilising solution.
2. Clean entire exterior surfaces of the machine working from top to bottom.

# 8.0 OPERATING

- 1 Check intermediate prover is switched on.  
Press **START BUTTON [1]** on prover control panel .  
This starts the prover in auto mode.  
(No movement will happen until dough passes the sensor on the chute.)
- 2 Check that the hopper is clear of objects and Smear interior with divider oil.

## ○ WARNING!

DO NOT USE ORDINARY VEGETABLE OIL FROM SHOP SHELVES, IN THE DIVIDER  
THIS WILL FORM A GUM-LIKE RESIDUE, CAUSING STICKING AND POSSIBLE DAMAGE TO THE MACHINE.

MONO RECOMMENDS THE USE OF “CRODA SUPER WUNDROL”  
(AVAILABLE FROM MONO. PART NUMBER “A900-25-272”)

## CONTROL POD BUTTONS

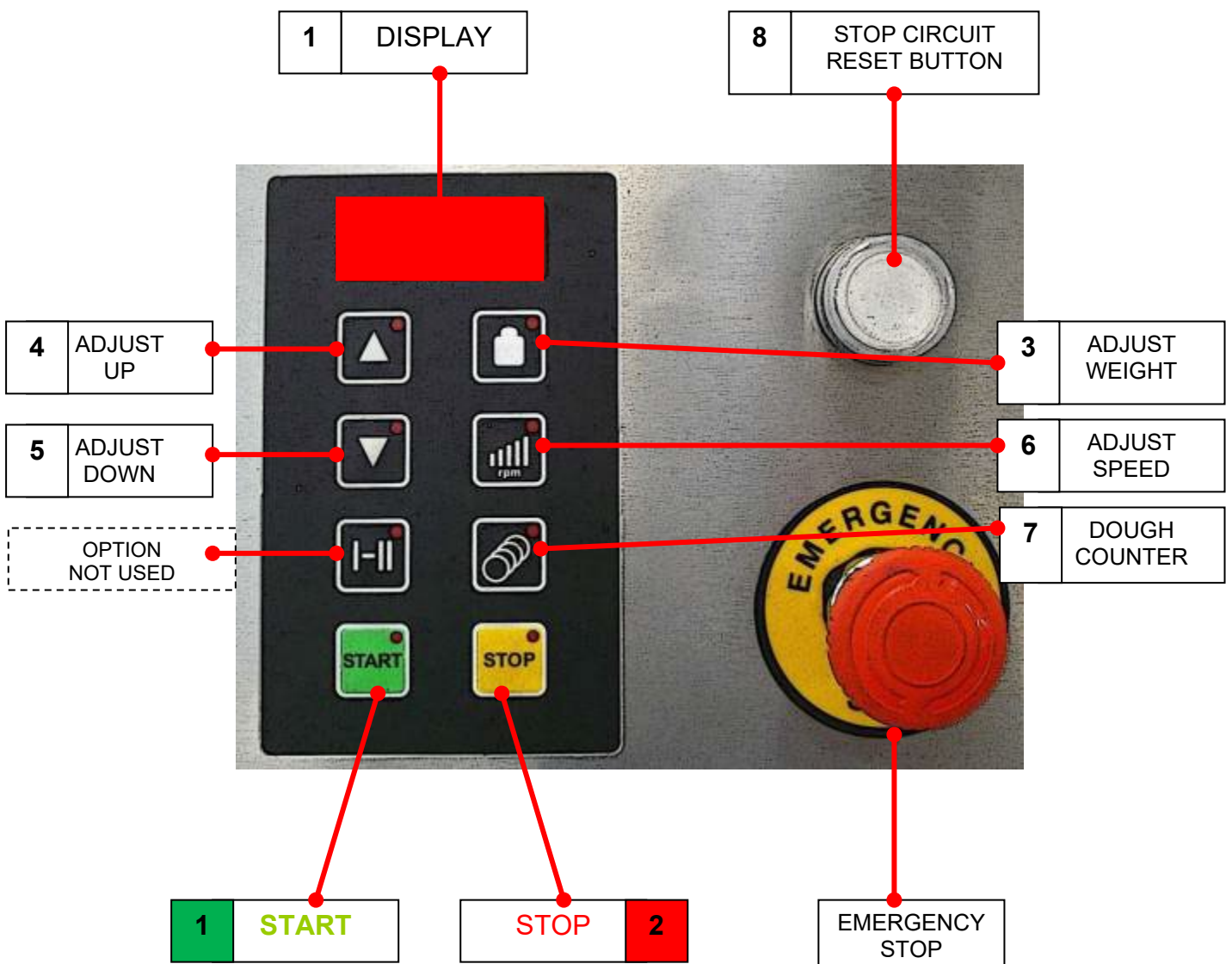

- 3 Run the divider for two minutes to allow oil to circulate. (Press “START” [1] )  
Then Stop the divider. (Press “STOP” [2] )

**Note:** *To prevent contamination, It is advisable to thoroughly check the hopper and off take conveyor for traces of a previous dough.*

- 4 Load dough into the hopper.
- 5 Run the machine (Press “START” [1] ) and check the first dough pieces out of the discharge conveyor for weight and cleanliness.

Adjust weight by pressing the “weight adjust button” [3] and then use the “adjust up” button [4] or the “adjust down” button [5] to alter the weight.

Make a note of the number showing in the display window for future reference.

(NOTE the number is only a reference to the setting and is not an indicator of weight, size etc.)

**(REPLACE CLEAN DOUGH INTO THE HOPPER. DO NOT PUT BACK ON CONVEYOR)**

*Normally the first six dough pieces are put back into the hopper, as weight consistency is suspect in the initial dough pieces.*

*If any dough pieces are contaminated with excess oil or traces of previous doughs e.g. Wholemeal, discard accordingly.*

- 6 Run dough through the divider.  
Care must be taken with weights, especially towards the end of a batch of dough.
- 7 Check the oil level in the tank frequently throughout shift and top up, if required.

**Note:** - *The divider is a volume divider that divides by size of dough piece, not by weight.*

***Be aware that dough is a “live” product and will expand in size during the dividing Process, so “check weigh” adjustments will have to be made during a batch of dough.***

**WARNING!** NEVER LEAVE DIVIDER WITH DOUGH INSIDE, AS PRESSURES CAN BUILD UP AS THE DOUGH PROVES



# **FLOUR DUSTER OPERATION**

TO ENSURE AN EVEN FLOW, ONLY USE CLEAN, DRY FLOUR.



DUSTER LOCATION

1

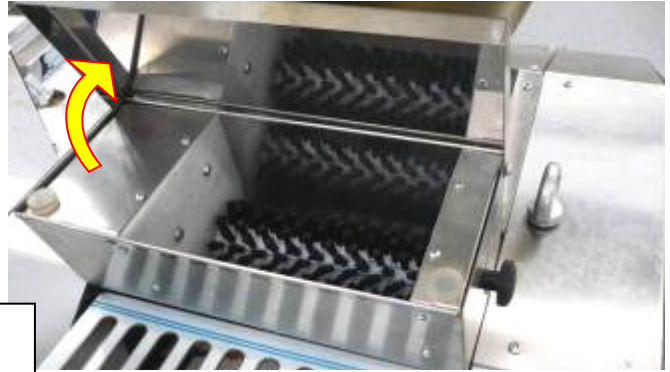

OPEN LID AND FILL WITH DRY FLOUR,  
THEN CLOSE THE LID

2



TURN ON POWER WHEN REQUIRED

3



ADJUST THE FLOW BY LOOSENING THE  
BLACK KNOB AND MOVING TO THE  
REQUIRED POSITION. RETIGHTEN KNOB.

## 9.0 MAINTENANCE

---



### WARNING

- This appliance must be maintained at regular intervals. The frequency of maintenance will depend upon your specific use and location. The maximum service interval should be 12 months.
- Service and maintenance should only be undertaken by suitably qualified, trained, and competent engineers.
- You must immediately report any damage or defect arising with the appliance.
- Unsafe equipment is dangerous. Do not use the appliance. Isolate the power supply and contact MONO or your appointed service agent.



### WARNING

- Isolate the Divider from the mains supply before attempting any maintenance operations.

Due to the low maintenance design of the divider, maintenance consists of the operations in the cleaning section and a few of the following checks:

- Conveyor belt adjustment (as required).
- Condition and greasing (check monthly)
- Weight adjuster chain condition and greasing (check monthly)

### Conveyor Belt Adjustment

Conveyor belt should be no tighter than necessary to eliminate slippage. Over tensioning can lead to belt and/or bearing failure. The belt should be adjusted by means of the adjustment tensioning nuts.

The belt should run with equal clearance between its edges and the conveyor unit side frames. If one edge of the belt is tighter than the other, it will tend to run towards the slack side. This tracking defect can be eliminated by individual adjustment of the tensioning nuts.

#### Caution

Adjustment nuts should not be continually tightened (this will cause bearing failure or the moulding belt to stretch and break). It may be that one side is too tight so should be eased off a little.

**ADJUSTMENT NUTS**  
(each side)

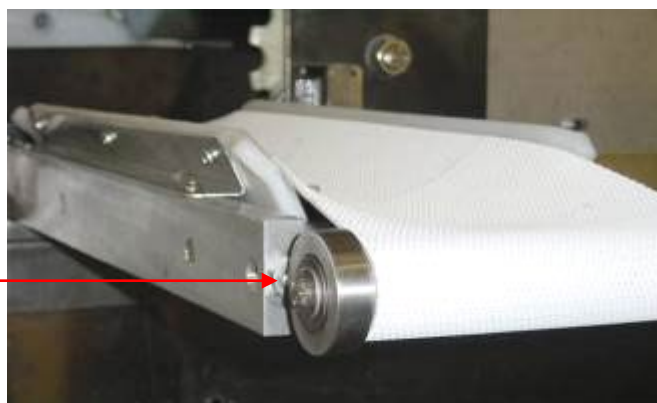

## Chain greasing



Open the side panels. (Remove 2 fixing screws each side and swing open).

Check that the main drive and weight adjusting chains are clean and greased.



WEIGHT ADJUSTER CHAIN

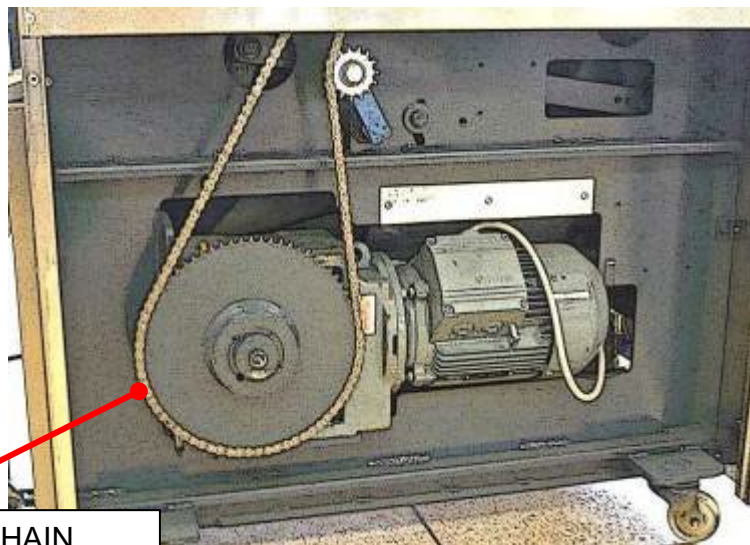

MAIN DRIVE CHAIN



# 10.0 TROUBLESHOOTING

---

## Divider does not run

- Check power is turned on at the isolator on the wall  
*For part of a bread plant check that the plant is connected and turned on.  
Check plug into intermediate prover is correctly connected.*
- Check all safety switches are operating (hopper closed etc.).
- Check a red “stop button” is not depressed (Turn to release.) and stop circuit reset button (8) has been pressed.

**WARNING: IF THERE IS ANY POSSIBILITY OF DAMAGE TO PLUGS OR LEADS, ISOLATE DIVIDER FROM PROVER BEFORE CHECKING.**



- If divider still does not function after carrying out these checks, call out “Mono” service dept.  
(see page 78)

## ◆ General Fault and Alarms

Faults and alarms indicate problems in the drive or in the machine.

An alarm is indicated by a code on the data display and the flashing ALM LED. The drive output is not necessarily switched off.

A fault is indicated by a code on the data display and the ALM LED is on. The drive output is always switched off immediately and the motor coast to stop.

To remove an alarm or reset a fault, trace the cause, remove it and reset the drive by pushing the Reset key on the operator or cycling the power supply.

This lists up the most important alarms and faults only. Please refer to the Technical Manual for a complete list.

LED Display	AL	FLT	Cause	Corrective Action
Base Block <i>bb</i>	○		The software base block function is assigned to one of the digital inputs and the input is off. The drive does not accept Run commands.	<ul style="list-style-type: none"> <li>• Check the digital inputs function selection.</li> <li>• Check the upper controller sequence.</li> </ul>
Control Fault <i>CF</i>		○	The torque limit was reached during deceleration for longer than 3 sec. when in Open Loop Vector control <ul style="list-style-type: none"> <li>• The load inertia is too big.</li> <li>• The torque limit is too low.</li> <li>• The motor parameters are wrong.</li> </ul>	<ul style="list-style-type: none"> <li>• Check the load.</li> <li>• Set the torque limit to the most appropriate setting (L7-01 through L7-04).</li> <li>• Check the motor parameters.</li> </ul>
Control Circuit Fault <i>[PP02 to [PP24</i>		○	There is a problem in the drive's control circuit.	<ul style="list-style-type: none"> <li>• Cycle the drive power supply.</li> <li>• Initialize the drive.</li> <li>• Replace the drive if the fault occurs again.</li> </ul>
Control Circuit Fault <i>[PP25</i>		○	There is no terminal board connected to the control board.	<ul style="list-style-type: none"> <li>• Check if the terminal board is installed properly.</li> <li>• Uninstall and Reapply the terminal board.</li> <li>• Change the drive.</li> </ul>
Cannot Reset <i>[r5r</i>	○		Fault reset was input when a Run command was active.	Turn off the Run command and reset the drive.
Option External Fault <i>EF</i>	○	○	An external fault was tripped by the upper controller via an option card.	<ul style="list-style-type: none"> <li>• Remove the fault cause, reset the fault and restart the drive.</li> <li>• Check the upper controller program.</li> </ul>
External Fault <i>EF</i>	○		A forward and reverse command were input simultaneously for longer than 500 ms. This alarm stops a running motor.	<ul style="list-style-type: none"> <li>• Check the sequence and make sure that the forward and reverse input are not set at the same time.</li> </ul>

LED Display	AL	FLT	Cause	Corrective Action
External Faults <i>EF 1 to EFG</i>	○	○	<ul style="list-style-type: none"> <li>An external fault was triggered by an external device via one of the digital inputs S1 to S6.</li> <li>The digital inputs are set up incorrectly.</li> </ul>	<ul style="list-style-type: none"> <li>Find out why the device tripped the EF. Remove the cause and reset the fault.</li> <li>Check the functions assigned to the digital inputs.</li> </ul>
Ground Fault <i>GF</i>		○	<ul style="list-style-type: none"> <li>Ground leakage current has exceeded 50% of the drives rated output current.</li> <li>Cable or motor insulation is broken.</li> <li>Excessive stray capacitance at drive output.</li> </ul>	<ul style="list-style-type: none"> <li>Check the output wiring and the motor for short circuits or broken insulation. Replace any broken parts.</li> <li>Reduce the carrier frequency.</li> </ul>
Safe Disable <i>Hbb</i>	○		Both Safe Disable inputs are open. The drive output is safely disabled and the motor can not be started.	<ul style="list-style-type: none"> <li>Check why the upper controller's safety device disabled the drive. Remove the cause and restart.</li> <li>Check the wiring.</li> <li>If the Safe Disable function is not utilized for EN60204-1, stop cat. 0 or for disabling the drive, the terminals HC, H1, H2 must be linked.</li> </ul>
Safe Disable Fault <i>HbbF</i>	○		<p>Drive output is disabled while only one of the Safe Disable inputs is open. (normally both input signals H1 and H2 should be open)</p> <ul style="list-style-type: none"> <li>One channel is internally broken and does not switch off, even if the external signal is removed.</li> <li>Only one channel is switched off by the upper controller.</li> </ul>	<ul style="list-style-type: none"> <li>Check the wiring from the upper controller and make sure that both signals are set correctly by the controller.</li> <li>If the signals are set correctly and the alarm does not disappear, replace the drive.</li> </ul>
Output Phase Loss <i>PF</i>		○	<p>Output cable is disconnected or the motor winding is damaged.</p> <p>Loose wires at the drive output.</p> <p>Motor is too small (less than 5% of drive current).</p>	<ul style="list-style-type: none"> <li>Check the motor wiring.</li> <li>Make sure all terminal screws in the drive and motor are properly tightened.</li> <li>Check the motor and drive capacity.</li> </ul>
Overcurrent <i>oC</i>		○	<p>Short circuit or ground fault on the drive output side</p> <p>The load is too heavy.</p> <p>The accel./decel. times are too short.</p> <p>Wrong motor data or V/f pattern settings.</p> <p>A magnetic contactor was switched at the output.</p>	<ul style="list-style-type: none"> <li>Check the output wiring and the motor for short circuits or broken insulation. Replace the broken parts.</li> <li>Check the machine for damages (gears, etc.) and repair any broken parts.</li> <li>Check the drive parameter settings.</li> <li>Check the output contactor sequence.</li> </ul>
Heatsink Overheat <i>oH or oH 1</i>	○	○	<p>Surrounding temperature is too high.</p> <p>The cooling fan has stopped.</p> <p>The heatsink is dirty.</p> <p>The airflow to the heatsink is restricted.</p>	<ul style="list-style-type: none"> <li>Check the surrounding temperature and install cooling devices if necessary.</li> <li>Check the drive cooling fan.</li> <li>Clean the heatsink.</li> <li>Check the airflow around the heatsink.</li> </ul>
Motor Overload <i>oL 1</i>		○	<p>The motor load is too heavy.</p> <p>The motor is operated at low speed with heavy load.</p> <p>Cycle times of accel./ decel. are too short.</p> <p>Incorrect motor rated current has been set.</p>	<ul style="list-style-type: none"> <li>Reduce the motor load.</li> <li>Use a motor with external cooling and set the correct motor in parameter L1-01</li> <li>Check the sequence.</li> <li>Check the rated current setting.</li> </ul>

LED Display	AL	FLT	Cause	Corrective Action
Drive Overload <i>OL2</i>		○	The load is too heavy. The drive capacity is too small. Too much torque at low speed.	<ul style="list-style-type: none"> <li>• Check the load.</li> <li>• Make sure that the drive is big enough to handle the load.</li> <li>• The overload capability is reduced at low speeds. Reduce the load or increase the drive size.</li> </ul>
DC Overvoltage <i>OU</i>	○	○	DC bus voltage rose too high. The deceleration time is too short. Stall prevention is disabled. Braking chopper / resistor broken. Unstable motor control in OLV. Too high input voltage.	<ul style="list-style-type: none"> <li>• Increase the deceleration time.</li> <li>• Enable stall prevention by parameter L3-04.</li> <li>• Make sure the braking resistor and braking chopper are working correctly.</li> <li>• Check motor parameter settings and adjust torque and slip compensation, AFR and hunting prevention as needed.</li> <li>• Make sure that the power supply voltage meets the drives specifications.</li> </ul>
Input Phase Loss <i>LF</i>		○	Input voltage drop or phase imbalance. One of the input phase is lost. Loose wires at the drive input.	<ul style="list-style-type: none"> <li>• Check the power supply.</li> <li>• Make sure that all cables are properly fixed to the correct terminals.</li> </ul>
Braking Transistor Fault <i>rr</i>		○	The internal braking transistor is broken.	<ul style="list-style-type: none"> <li>• Cycle the power supply.</li> <li>• Replace the drive if the fault reoccurs.</li> </ul>
DC Undervoltage <i>UU1</i>	○	○	The voltage in the DC bus fell below the undervoltage detection level (L2-05). The power supply failed or one input phase has been lost. The power supply is too weak.	<ul style="list-style-type: none"> <li>• Check the power supply.</li> <li>• Make sure, that the power supply is strong enough.</li> </ul>
Controller Undervoltage <i>UU2</i>		○	The drives controller power supply voltage is too low.	<ul style="list-style-type: none"> <li>• Cycle power to the drive. Check if the fault reoccurs.</li> <li>• Replace the drive if the fault continues to occur.</li> </ul>
DC Charge Circuit Fault <i>UU3</i>		○	The charge circuit for the DC bus is broken.	<ul style="list-style-type: none"> <li>• Cycle power to the drive. Check if the fault reoccurs.</li> <li>• Replace the drive if the fault reoccurs.</li> </ul>

## ◆ Operator Programing Errors

An Operator Programming Error (OPE) occurs when an inapplicable parameter is set or an individual parameter setting is inappropriate. When an OPE error is displayed, press the ENTER button to display U1-18 (OPE fault constant). This monitor will display the parameter that is causing the OPE error.

LED Operator Display	Cause	Corrective Action
oPE01 oPE01	Drive capacity and value set to o2-04 do not match.	Correct the value set to o2-04.
oPE02 oPE02	Parameters were set outside the allowable setting range.	Set parameters to the proper values.
oPE03 oPE03	A contradictory setting is assigned to multi-function contact inputs H1-01 through to H1-06. <ul style="list-style-type: none"> <li>• The same function is assigned to two inputs. (this excludes "External fault" and "Not used")</li> <li>• Input functions which require the setting of other input functions were set alone.</li> <li>• Input functions that are not allowed to be used simultaneously have been set.</li> </ul>	<ul style="list-style-type: none"> <li>• Fix any incorrect settings.</li> <li>• Refer to the Technical Manual for more details.</li> </ul>
oPE05 oPE05	<ul style="list-style-type: none"> <li>• The run command source (b1-02) or frequency reference source (b1-01) is set to 3 but no option board is installed.</li> <li>• The frequency reference source is set to pulse input but H6-01 is not 0.</li> </ul>	<ul style="list-style-type: none"> <li>• Install the required option board.</li> <li>• Correct the values set to b1-01 and b1-02.</li> </ul>
oPE07 oPE07	Settings to multi-function analog inputs H3-02 and H3-10 and PID functions conflict. <ul style="list-style-type: none"> <li>• H3-02 and H3-10 are set to the same value. (this excludes settings "0" and "F")</li> <li>• PID functions have been assigned to both analog inputs and the pulse input at the same time.</li> </ul>	<ul style="list-style-type: none"> <li>• Fix any incorrect setting.</li> <li>• Refer to the Technical Manual for more details.</li> </ul>
oPE08 oPE08	A function has been set that cannot be used in the control mode selected.(might appear after control mode change)	<ul style="list-style-type: none"> <li>• Fix any incorrect setting.</li> <li>• Refer to the Technical Manual for more details.</li> </ul>
oPE10 oPE 10	The V/f pattern setting is incorrect.	<ul style="list-style-type: none"> <li>• Check the V/f pattern settings.</li> <li>• Refer to the Technical Manual for more details.</li> </ul>

## ◆ Auto-Tuning Errors

LED Operator Display	Cause	Corrective Action
Er-01 <i>Er-01</i>	Motor data fault The input motor data are not valid, (e.g. the base frequency and base speed do not fit).	Re-enter the data and repeat Auto-Tuning.
Er-02 <i>Er-02</i>	Minor Fault • The wiring is faulty. • The load is too heavy.	• Check the wiring. • Check the load. Always perform Auto-Tuning with the load decoupled from the motor.
Er-03 <i>Er-03</i>	The STOP button was pressed and Auto-Tuning was canceled.	Repeat the Auto-Tuning.
Er-04 <i>Er-04</i>	Resistance fault • Wrong input data. • Auto tuning exceeded the given time frame. • Calculated values out of range.	• Check the input data. • Check the wiring. • Re-enter the data and repeat the Auto-Tuning.
Er-05 <i>Er-05</i>	No-Load Current Error • Incorrect data was entered. • Auto tuning took too long. • Calculated values out of range.	
Er-08 <i>Er-08</i>	Rated Slip Error • Wrong data input. • Auto tuning exceeded the given time frame. • Calculated values out of range.	
Er-09 <i>Er-09</i>	Acceleration error The motor did not accelerate for the specified acceleration time.	• Increase the acceleration time C1-01. • Check the torque limits L7-01 and L7-02.
Er-11 <i>Er-11</i>	Motor speed fault. The torque reference was too high.	• Increase the acceleration time (C1-01). • If possible, disconnect the load.
Er-12 <i>Er-12</i>	Current detection error • One or all output phases are lost. • Current is either too low or exceeds the drives rating. • The current sensors are faulty.	• Check the wiring. • Make sure, that the drive rating fits to the motor. • Check the load. (Auto-Tuning should have been performed without the load connected.) • Replace the drive.
End1 <i>End1</i>	Rated current alarm • The torque reference exceeded 20% during Auto-Tuning. • The calculated no-load current is above 80% of the motor rated current.	• Check the V/f pattern setting. • Perform Auto-Tuning without the load connected. • Check the input data and repeat Auto-Tuning.
End2 <i>End2</i>	Motor iron-core saturation alarm • Calculated core saturation values out of range. • Incorrect data was entered.	• Check the input data. • Check the motor wiring. • Perform Auto-Tuning without load connected.
End3 <i>End3</i>	Rated current alarm	Check the input data and repeat tuning.

# YASKAWA INVERTER DEFAULT SETTINGS

	3KW
A1 03	2220
A1 02	0 2
C1 01	0001.0
C1 02	0000.5
C4 02	000.30
C6 02	0 5
D2 02	033.0
E2 01	014.40
E1 04	060.0
H2 01	000
H3 03	0048.0
H3 04	0015.0
H3 13	1,3 0
L1 01	03
L8 07	0 2

## 11.0 SPARES AND SERVICE ---

If a fault arises, please do not hesitate to contact the Customer Service Department, quoting the **machine serial number** on the silver information plate of the machine and on the front cover of this manual

### SPARES and OVERSEAS SUPPORT:

#### MONO

Queensway  
Swansea West Industrial Estate  
Swansea. SA5 4EB UK

**email:**[spares@monoequip.com](mailto:spares@monoequip.com)  
**Web site:**[www.monoequip.com](http://www.monoequip.com)

**Tel. 01792 561234**  
**Fax. 01792 561016**



## 12.0 ELECTRICAL INFORMATION —

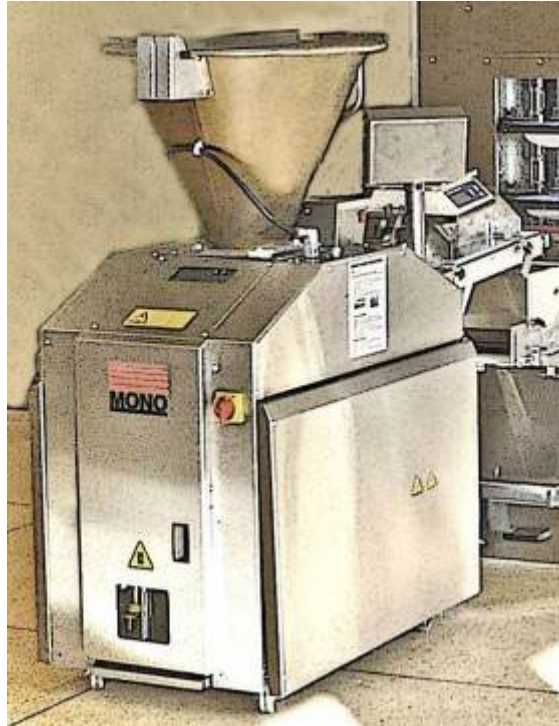

**Note**

Due to continual improvements this section may not be correct for your model. Please contact MONO before using.

# ELECTRICAL DISTRIBUTION

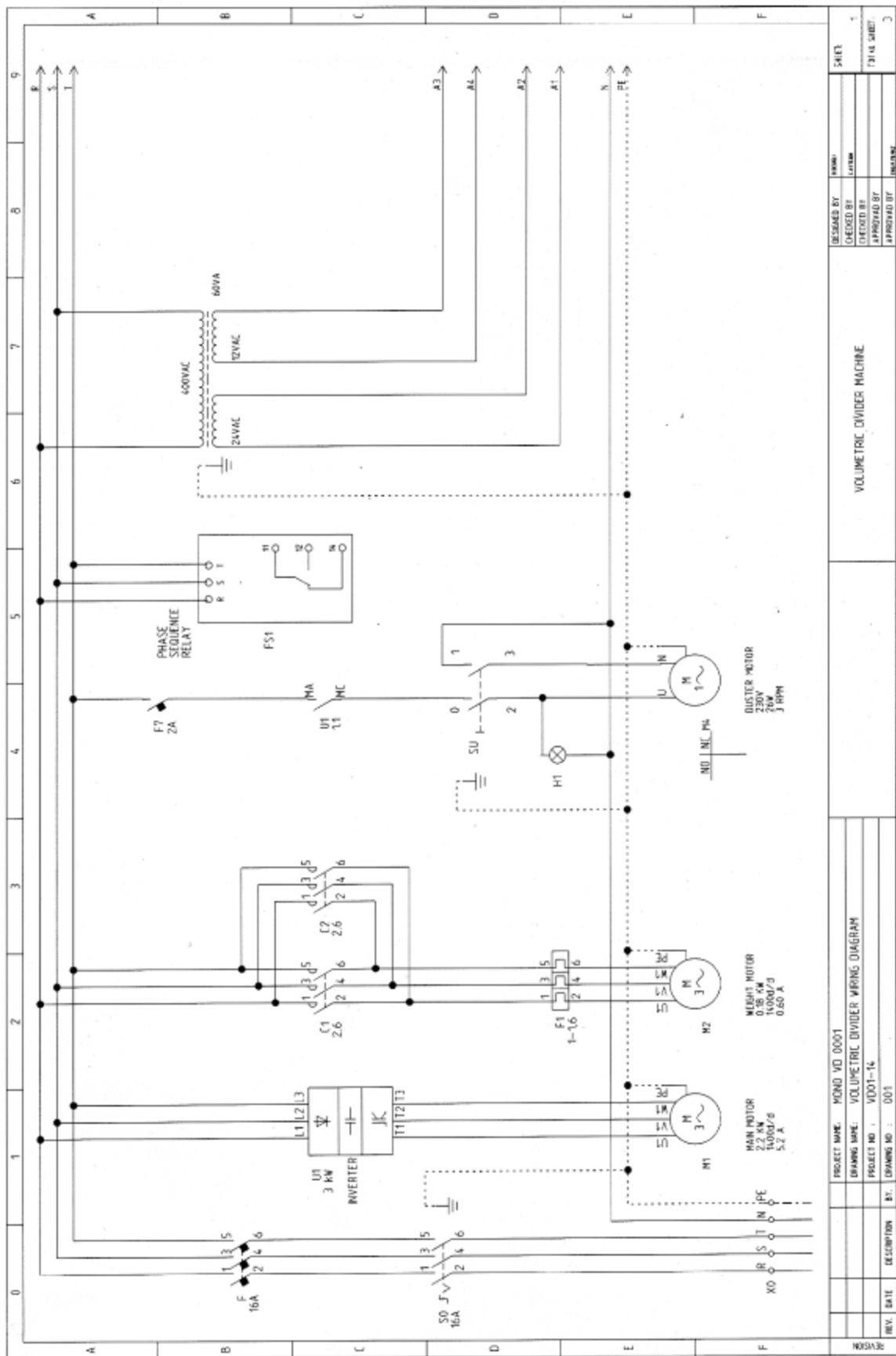

# CONTROL CIRCUIT

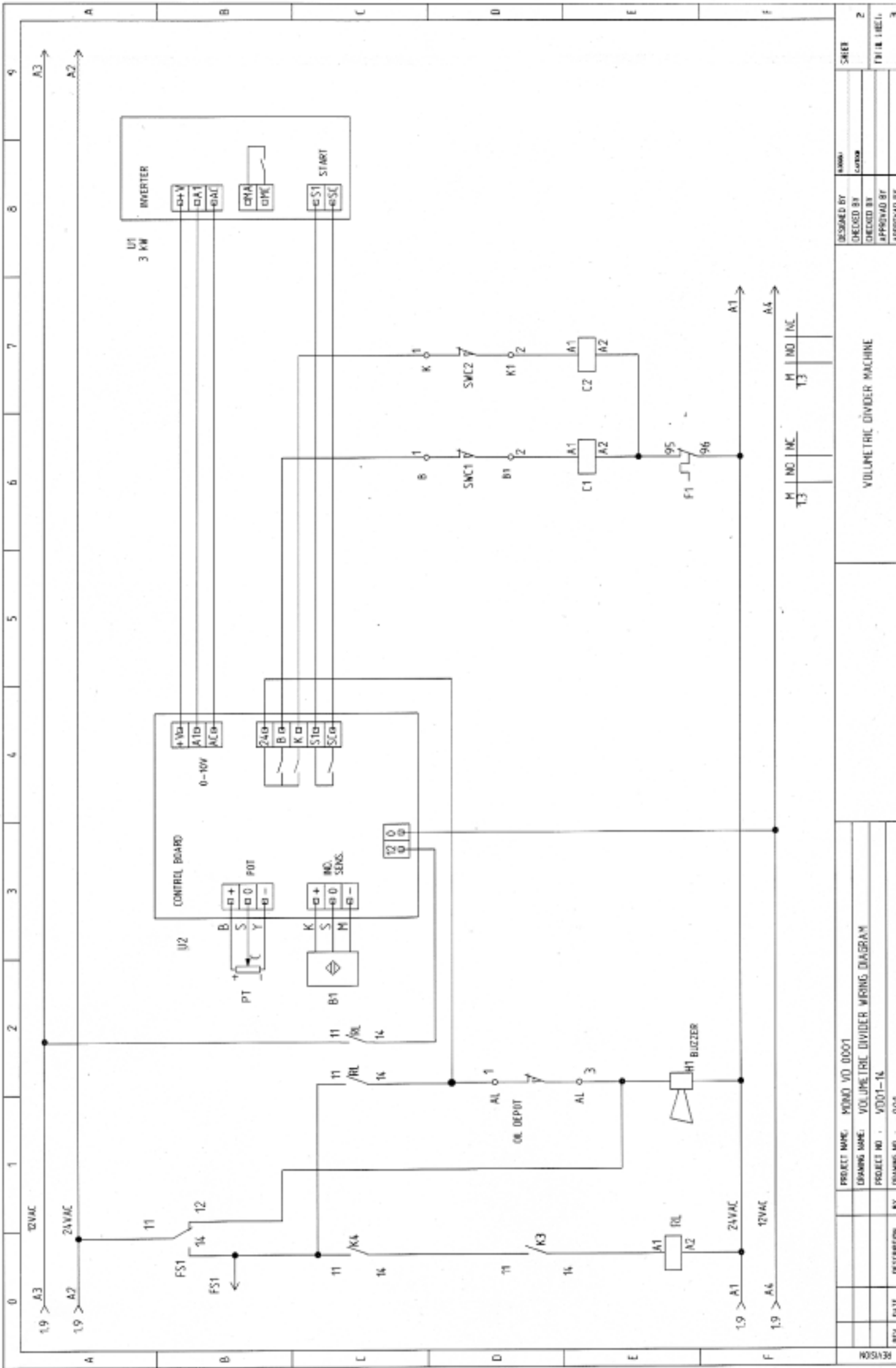

DESIGNED BY	U2000	SHEET	2
CHECKED BY	U2000	FIG. NO.	2
APPROVED BY		FIG. 1 (REV.)	3
DATE			
DESCRIPTION	VOLUMETRIC DIVIDER MACHINE		
PROJECT NAME	MONO V.D. 0001		
DRAWING NAME	VOLUMETRIC DIVIDER WIRING DIAGRAM		
PROJECT NO.	V001-16		
DRAWING NO.	001		



# SECTION 3



FULL OPERATING AND MAINTENANCE  
MANUAL  
FOR THE  
BREADPLANT **MOULDER**

MOULDER

# IMPORTANT NOTES

IF YOU ENCOUNTER ANY ISSUE WITH THIS EQUIPMENT THAT YOU HAVE NOT BEEN TRAINED FOR, YOU MUST CONTACT YOUR INSTORE TECHNICIAN.

## MONO FUSION PLANT MOULDER SETTINGS GUIDE

PLEASE NOTE THAT THESE ARE APPROXIMATE SETTINGS AND SHOULD ONLY BE USED AS A STARTING POINT

PRODUCT	WATER	MIX TIME	SHEETER	INITIAL FLAP	REAR FLAP	FRENCH LENGTH	LOAF LENGTH	MOULDING PRESSURE
980G BREAD	9	2-8 MINS	11	UP	DOWN	N/A	10	260-280
520G BREAD	9.3	2-8 MINS	11	UP	DOWN	N/A	6	260-280
550G FRENCH	9.1	2-8 MINS	5	DOWN	UP	5	N/A	N/A
260G BATON	9.1	2-8 MINS	5	UP	UP	7	N/A	N/A

Ensure the moulder is set up and adequate tins and trays are available before starting the breadplant.

# CONTENTS ----- MOULDER SECTION

1.0	INTRODUCTION .....	88
2.0	OVERALL DIMENSIONS .....	88
3.0	SPECIFICATIONS.....	89
4.0	SAFETY.....	90
5.0	INSTALLATION.....	91
6.0	ISOLATION .....	92
7.0	CLEANING INSTRUCTIONS .....	92
	▪ Daily.....	93
	▪ Weekly .....	99
8.0	OPERATING INFORMATION .....	100
9.0	OPERATING INSTRUCTIONS.....	101
	▪ Moulding between belts (French stick and petit pan).....	102
	▪ Moulding Between Rear Belt & Pressure Board (Tin and Bloomers) .....	103
10.0	MAINTENANCE .....	104
11.0	TROUBLESHOOTING .....	106
12.0	SPARES AND SERVICE.....	107

---

**FOR SERVICE AND SPARES RING: 01792 564044**

---

13.0	MOULDER ELECTRICAL INFORMATION.....	110
------	-------------------------------------	-----

# 1.0 INTRODUCTION

---

**MONO's Moulder** combines the capabilities of traditional bread and French stick moulding machines. Its small footprint and simple controls are of particular benefit in small bakeries and when used with an automatic bread plant.

The Moulder will process up to 900 dough pieces an hour.

# 2.0 OVERALL DIMENSIONS

---

Height: 1825mm.

Depth: 1205mm.

Width: 1020mm.

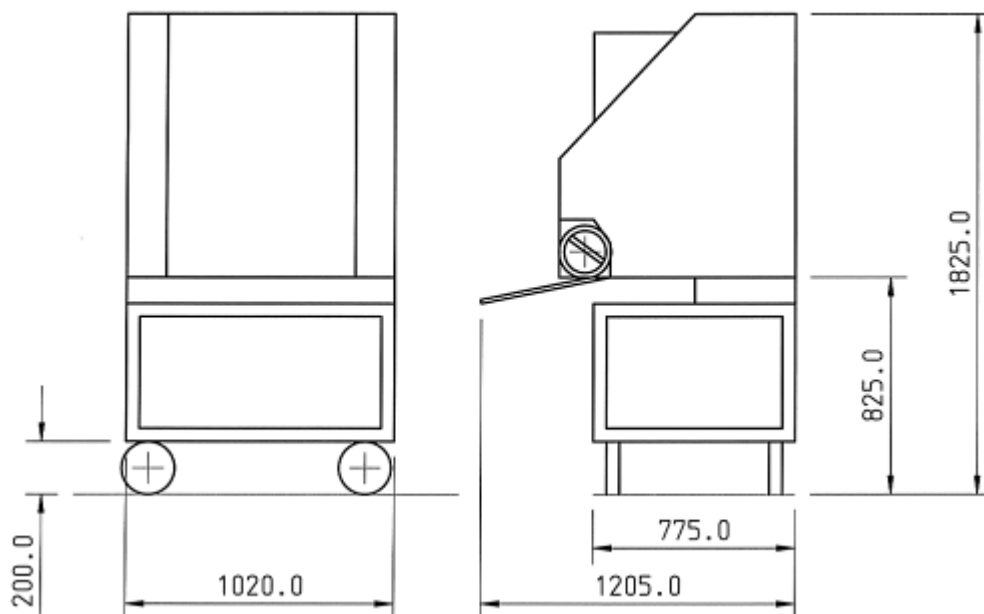



## 3.0 SPECIFICATIONS

---

**Total power:** 0.75kW three phase

**Capacity:** Up to 900 dough pieces processed every hour, between 250g (9oz) and 0.9kg (2lb) in weight and between 125mm (5") and 760mm (30")

**Weight:** 430kg

**Noise level:** *Less than 85dB.*

## 4.0 SAFETY



**IF YOU ENCOUNTER ANY ISSUE WITH THIS EQUIPMENT THAT YOU HAVE NOT BEEN TRAINED FOR, YOU MUST CONTACT YOUR INSTORE TECHNICIAN.**



- 1 Never use a machine in a faulty condition and always report damage.
- 2 No one under 16 may operate this machine.
- 3 No one under 18 may clean this machine.
- 4 Only trained and authorised persons may remove any part that requires a tool to do so.



- 5 Always ensure hands are dry before touching any electrical appliance (including cable and plug).
- 6 All operatives must be fully trained.
- 7 People undergoing training on the machine must be under direct supervision of a trainer.
- 8 Do not operate with any panels removed.
- 9 All guards must be fixed in place with bolts or screws unless protected by a safety switch.
- 10 No loose clothing or jewellery to be worn while operating the machine.
- 11 Switch off power at the mains isolate switch or isolate at the main control box
- 12 The Bakery Manager or the bakery Supervisor must carry out daily safety checks.
- 13 **Warning: Do not attempt to scrape moulding belts when moulder is running.**
- 14 Any internal maintenance must be by fully trained maintenance personnel.



### **WARNING:**

Hand or bodily contact with moving belt surfaces may cause friction burns to skin.  
This situation need not occur to successfully operate the moulder.



**ALL CLEANING AND MAINTENANCE OPERATIONS MUST BE MADE WITH MACHINE DISCONNECTED FROM THE POWER SUPPLY**

# 5.0 INSTALLATION

---

1. Ensure machine is standing on a solid level floor. Correctly position moulder using the male locator. The locator should be pushed in until the end of it pushes up against the stop. Clamp in position with clip. Lock the two front castors into place after the connection is made.
2. The Moulder should be connected to the correct sockets on the prover.

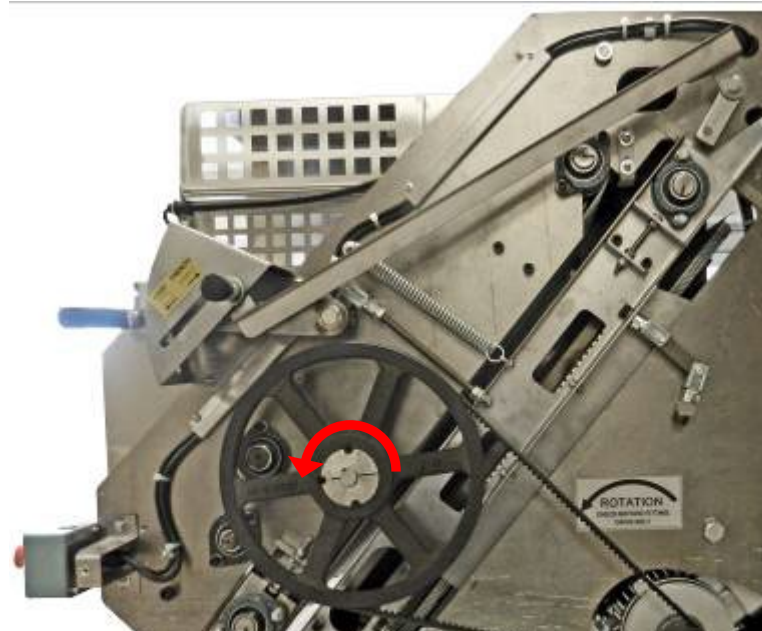
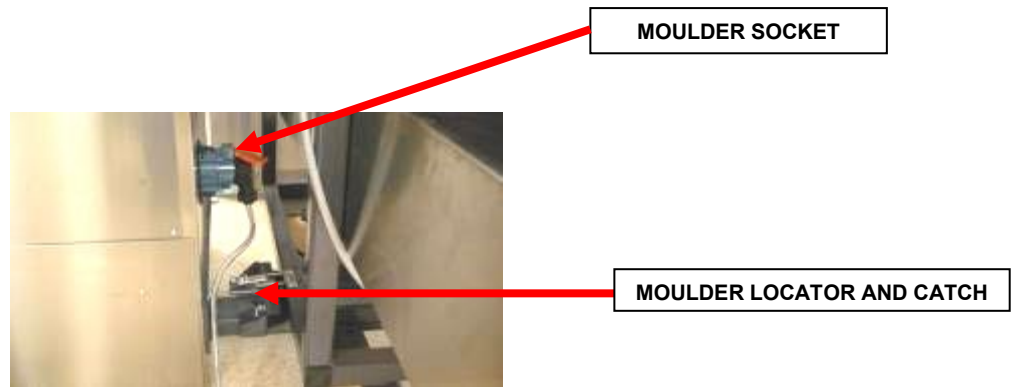

3. Check machine after installation to ensure drive motor rotation is in the direction of arrow. This should be done with drive V-belt removed. If motor rotation is incorrect, change round any two of the three phase carrying wires. Drive motor should be travelling in an anti-clockwise direction.

## 6.0 ISOLATION

---

To stop the moulder in an emergency, switch off at the prover main isolator, or use the emergency stop button either on the plant control panel or the moulder .

PROVER OVERHEAD PANEL

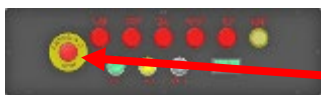

PROVER MAIN ISOLATOR



TO STOP MOULDER

To release stop button after use, twist and release.



# 7.0 CLEANING

## MOULDER CLEANING



**NOTE:- SWITCH OFF AND ISOLATE FROM THE MAINS SUPPLY BEFORE COMMENCING ANY CLEANING**

### DAILY CLEANING INSTRUCTIONS

**NOTE! –**  
USE PLASTIC SCRAPERS TO REMOVE SUBSTANTIAL DOUGH PIECES PRIOR TO CLEANING.

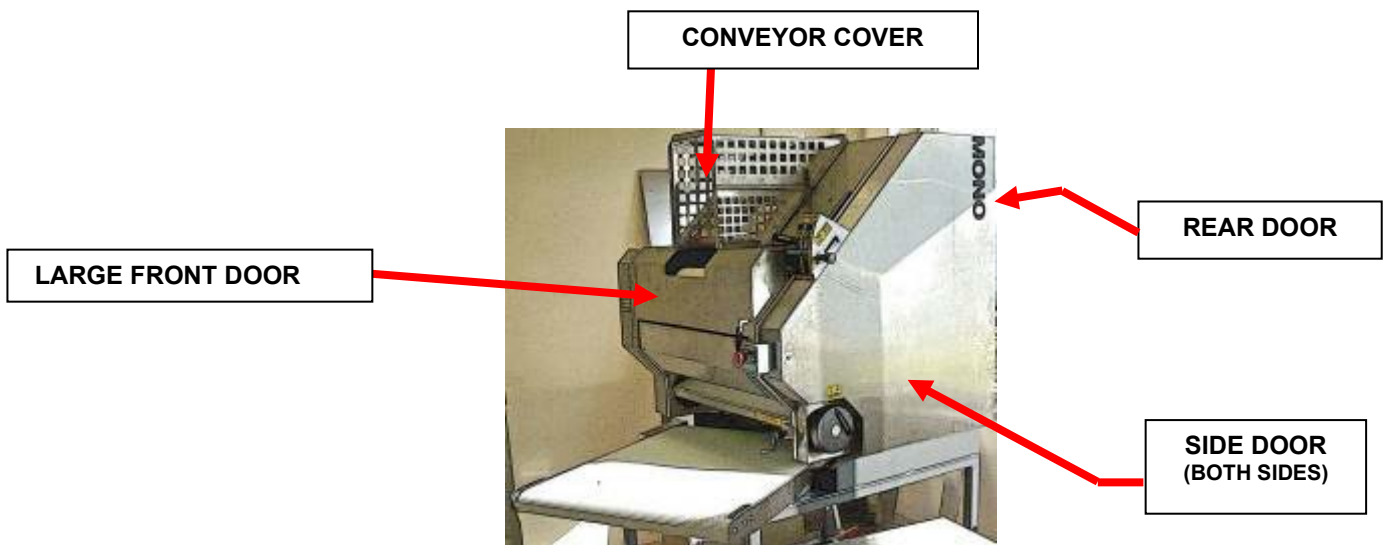

1. Isolate the mains supply. (See previous page)
2. Open large front door.



## SET SHEETING GAP

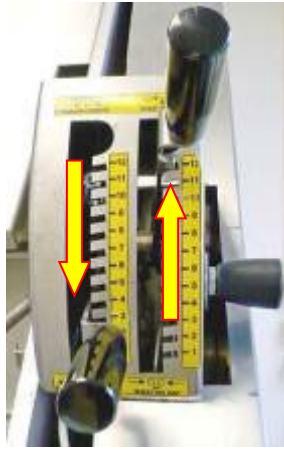

4. Set sheeting gap to the widest mark and brush out residue from the area, using a plastic scraper on the rollers if required.
  
5. Clean any residue that has been trapped at the bottom of the belt.  
Scrape exposed surface of the dough-moulding belt with **plastic** scraper.
  
7. Brush/vacuum the area.

# SCRAPER AND CURLING CHAIN REMOVAL

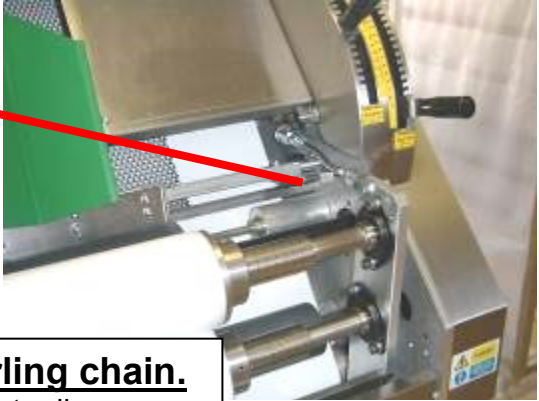

**To remove scraper and curling chain.**  
Slide clips sideways and lift up bar to disengage  
(one each side).



CLIP CLOSED

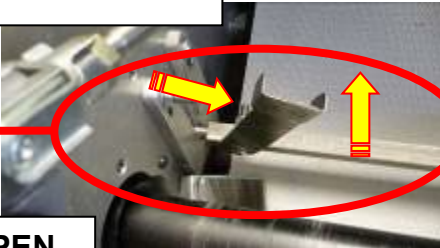

CLIP OPEN

**Detach top of curling chain**  
Lift chain off top bar and remove curling chain and scraper.

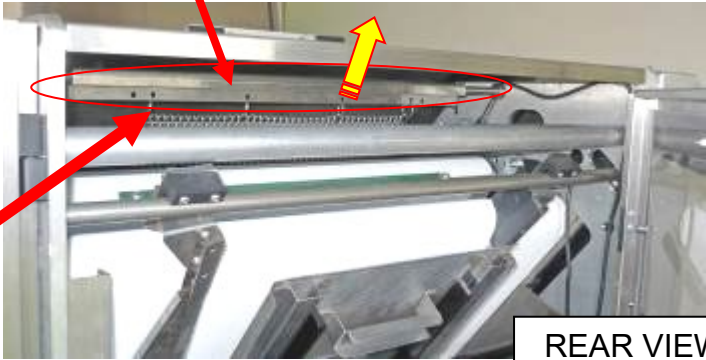

REAR VIEW



**To replace scraper and curling chain.**

Clean and then replace the curling chain by dropping down conveyor from the back and clipping in place at the front. (Reverse of removal).

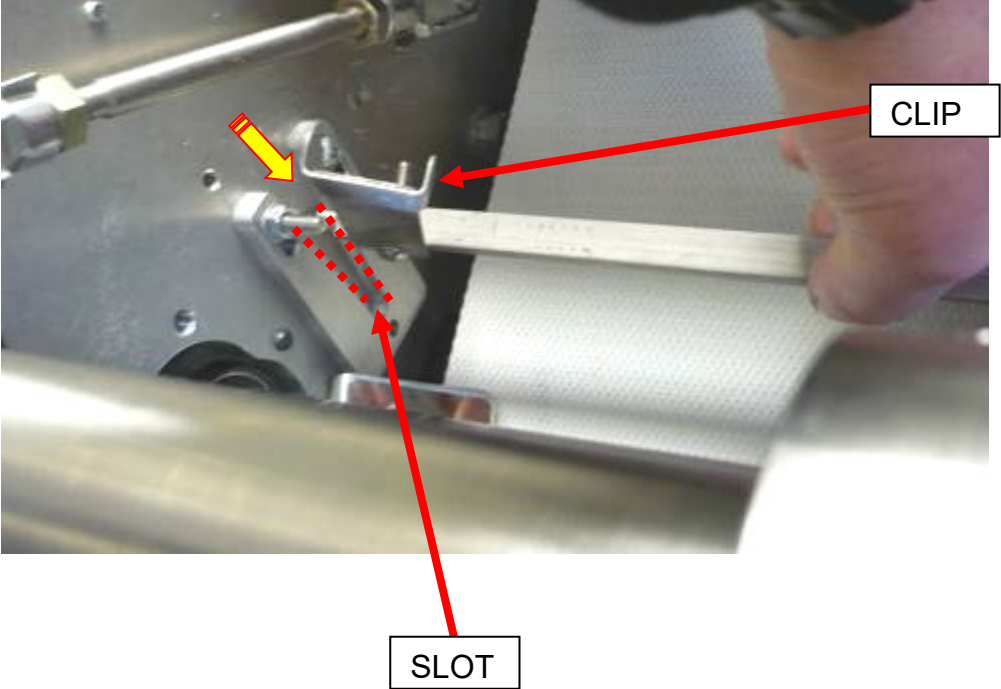



## Pressure Board Removal

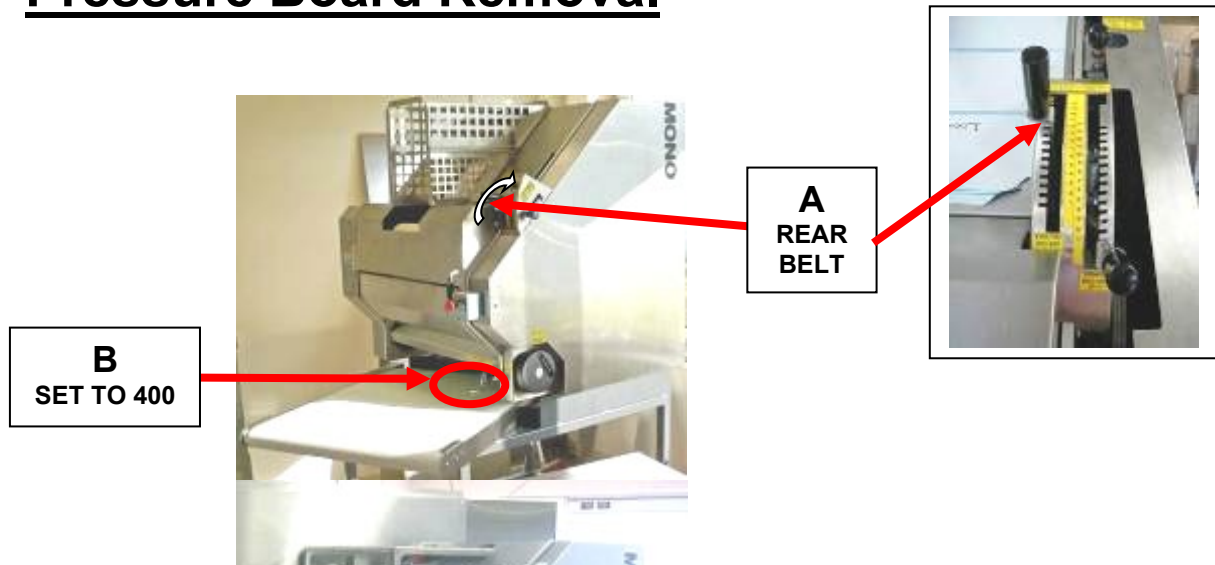

1. Fully lower the rear-moulding belt using lever [A] and fully lower the pressure board by adjusting handle [B] to setting "400" on the counter. Open rear door.
2. Remove the pressure board by gripping the handle provided, and then lift up and out.

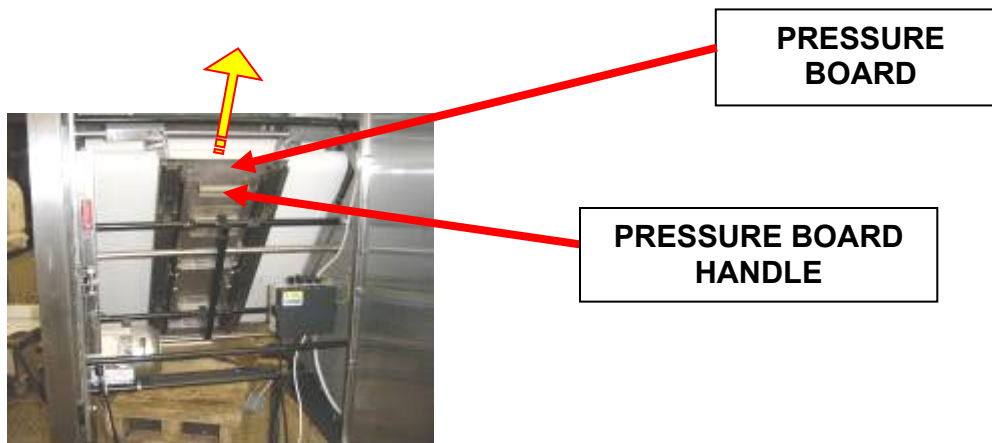

3. Wash dough contact surfaces of the pressure board and side guides with sanitising solution and hot water. Dry with cloth.
4. Remove any dough from the bottom belt with a plastic scraper.
5. Replace the pressure board, making sure the hooks on the board are fully engaged.

**Close the rear door firmly to make the safety switch connection.**

## OFF TAKE CONVEYOR

Should be scraped clean with a plastic scraper.

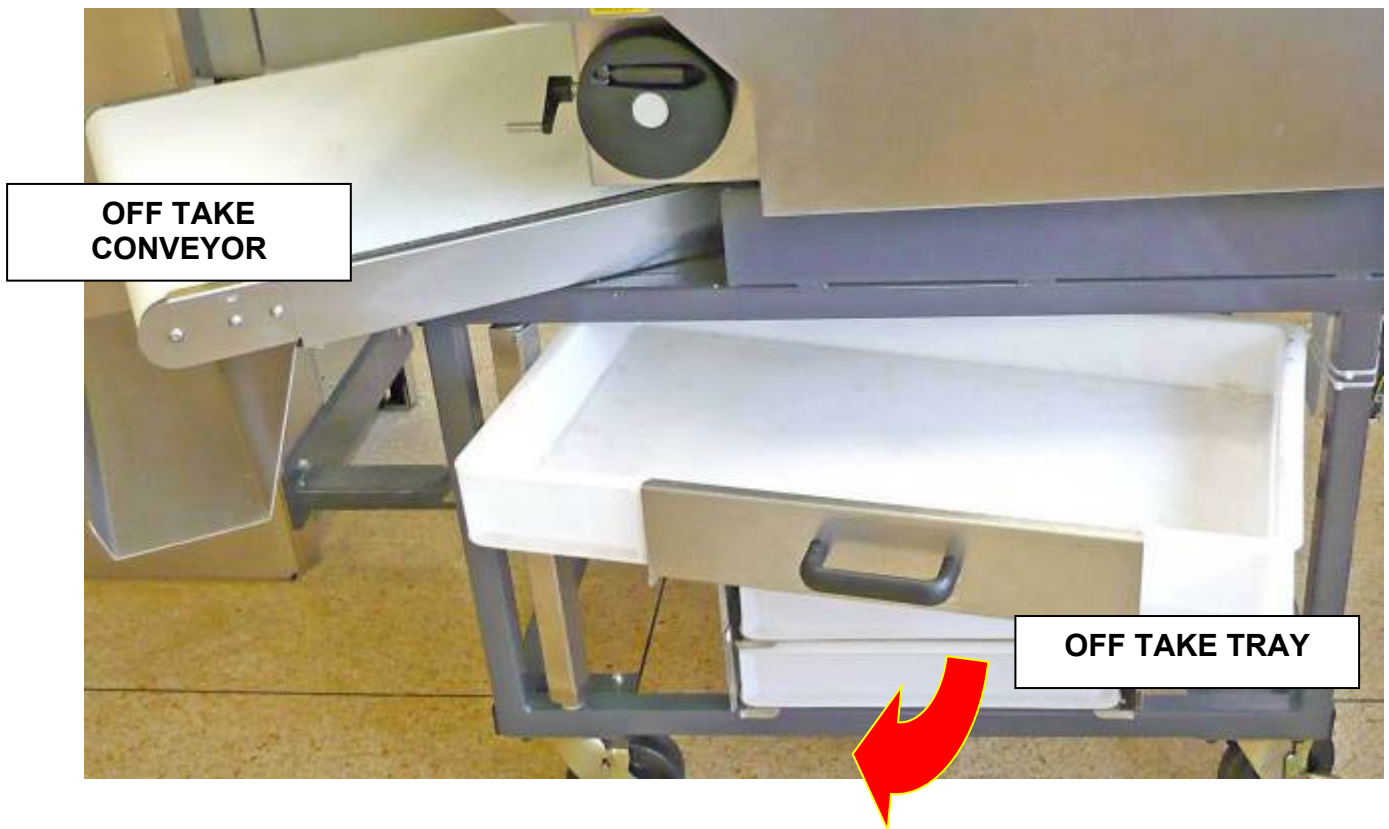

## OFF TAKE TRAY

Pull out the off take tray shelf and remove the plastic tray.  
Wash well and dry.  
Replace.

And finally to complete "Daily Cleaning"

- Brush down all external surfaces of the machine including the stand.
- Sweep under machine to remove all debris from the floor.
- Spot clean with dampened cloth, sanitising solution and hot water, paying particular attention to handles, levers and controls.

# WEEKLY CLEANING INSTRUCTIONS

AS DAILY INSTRUCTIONS AND ALSO:

1. ***Remove the moulder mains plug from prover and unclip positioning locator on base.***
  
  2. Pull the moulder away from prover.
  
  - 3 Wipe the stand with a cloth dampened with disinfecting solution and hot water.
  
  - 4 Scrape and scrub the wheels on the machine.
  
  - 5 Wipe down all external surfaces with disinfecting solution and hot water.  
Dry with a cloth.
-

## 8.0 OPERATING INFORMATION

- 1 The Moulder should be used on a level floor for the best results.
- 2 All control levers, handles, etc. are best adjusted when the moulder is running, although they can be adjusted with the machine stationary.

### Machine cycle information.

- 1 The moulding elements consist of two dough guides, two differential sheeting rollers, a guide roller, a stripper roller, a removable curling chain, two endless polyurethane belts rotating in the same direction, a two position deflector, a pressure board, a pair of dough guides and an offtake tray.
- 2 Dough is delivered from the prover conveyor. The dough is then sheeted through the two differential rollers into a pancake shape.
- 3 The dough piece is taken off the rollers by means of a stripper roller and guided by the remaining roller onto the endless polyurethane belt. Upon making contact with the belt the dough piece is immediately pressurised by the curling chain mat. The light pressure produced by the chain causes the dough piece to roll over on its self and produce a sausage shape.
- 4 At this stage in the moulding process the dough path can be selected, via pushrod to be further processed either between front and rear belts or between the rear belt and pressure board.
- 5 Both of the moulding routes chosen will deposit the finished dough piece onto an offtake tray.

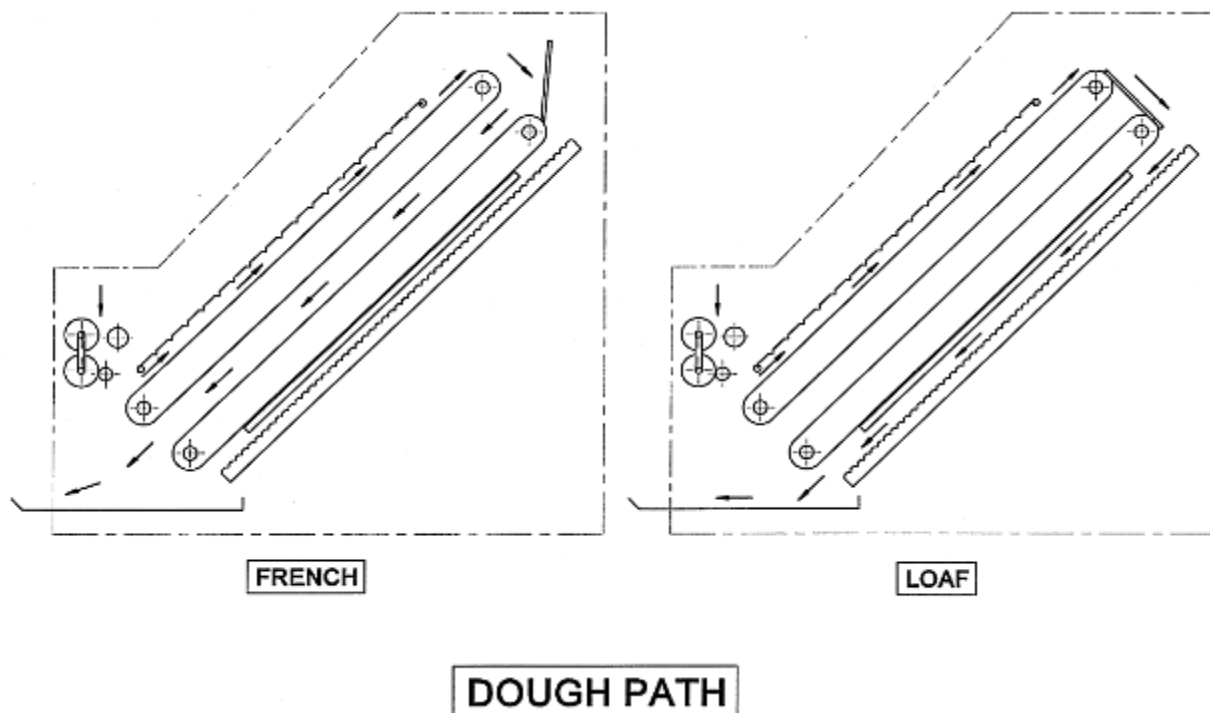

# 9.0 OPERATING INSTRUCTIONS

**E**

**A**

Ensure the moulder is set up and adequate tins and trays are available before starting.

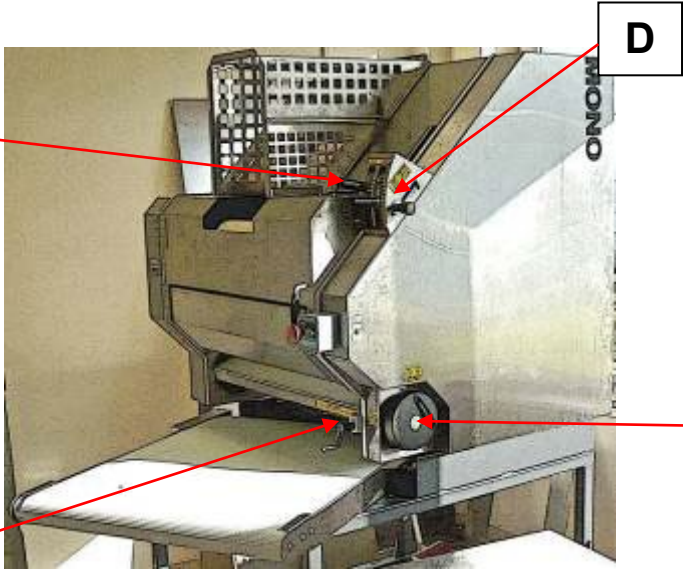
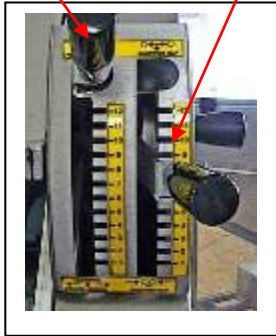

**B**

**D**

**C**

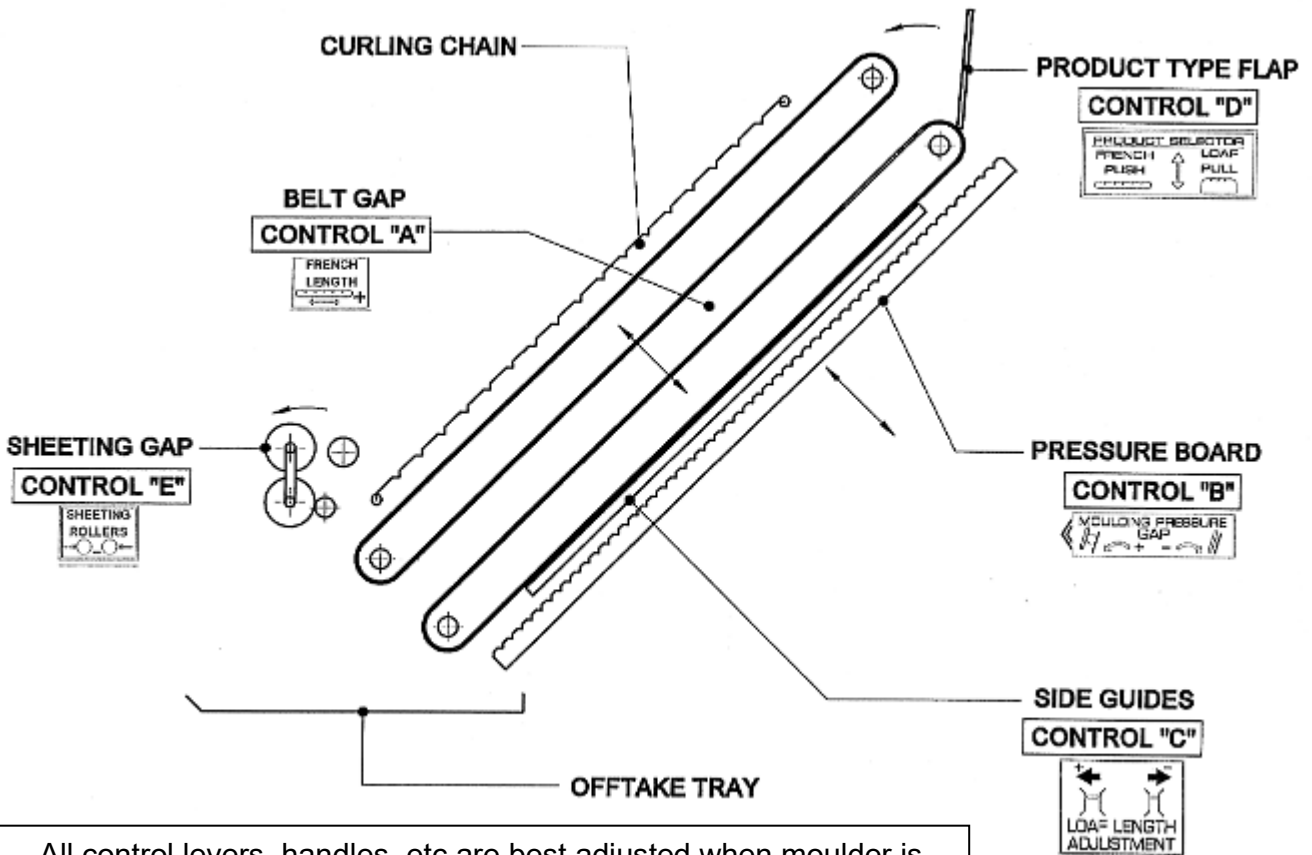

All control levers, handles, etc are best adjusted when moulder is running, although they can be adjusted with the machine stationary.

# MOULDING BETWEEN BELTS FRENCH STICK AND PETIT PAIN PRODUCTS.

Push lever "D" to position required (FRENCH)

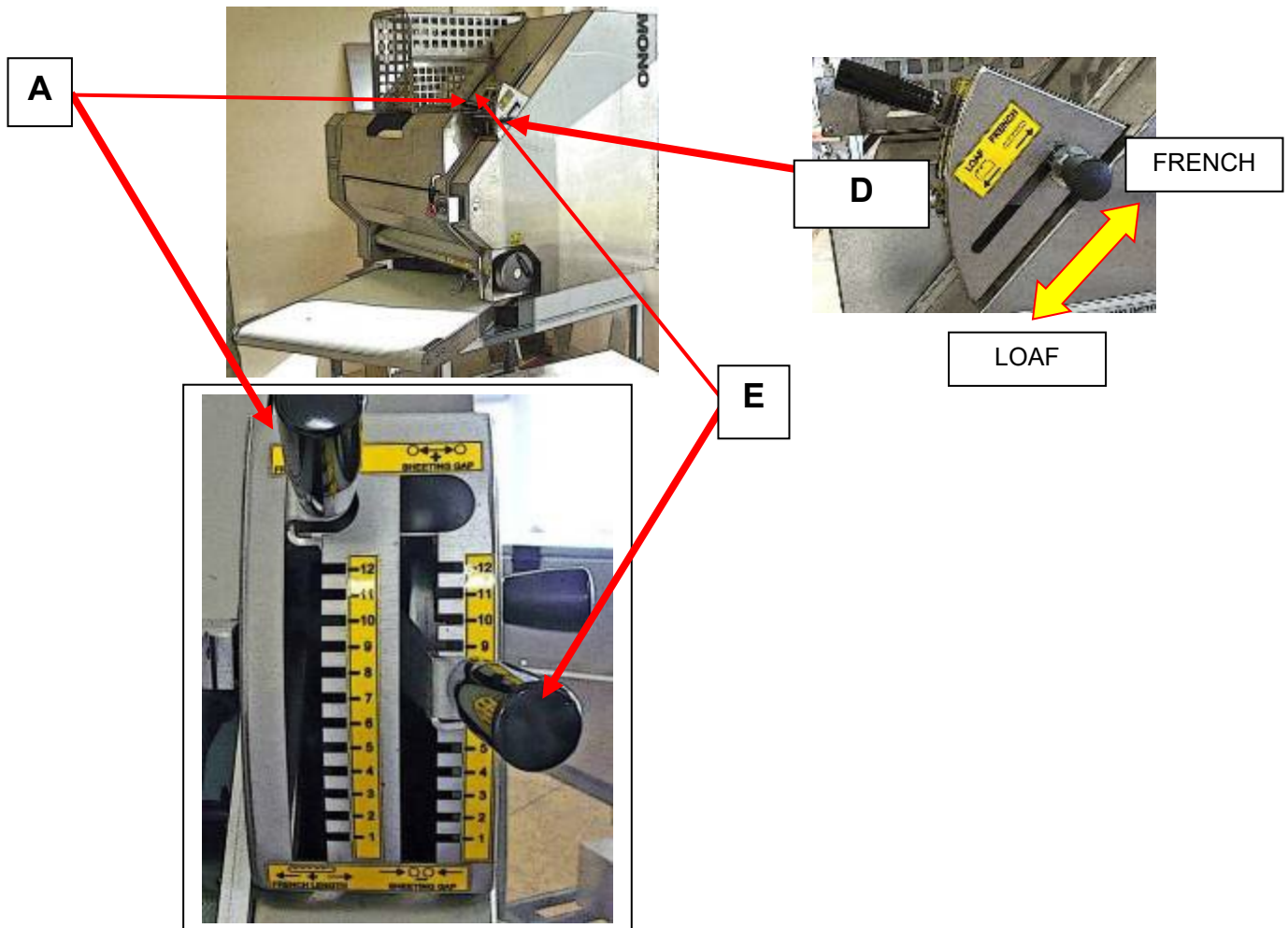

- 1 Set lever "A" to control the length of the dough piece required.
- 2 Adjust "E" to open or close the sheeting gap of the two infeed rollers.
  - *Control settings will vary according to user, dough mixes, product, machine construction etc., and are best established by the user.*
  - *It is advisable for the Bakery Manager to inform staff of settings required for all French range once established. This will result in consistent product, assuming dough condition is constant.*

## MOULDING BETWEEN REAR BELT AND PRESSURE BOARD TIN BREAD & BLOOMERS.

Push lever "D" to position required (LOAF)

- 1 **Position control lever "A" to position 0** – *this ensures the correct transfer of the dough piece after curling and correct discharge onto the return conveyor.*
- 2 **Adjust handle "E"** for the infeed sheeting gap.

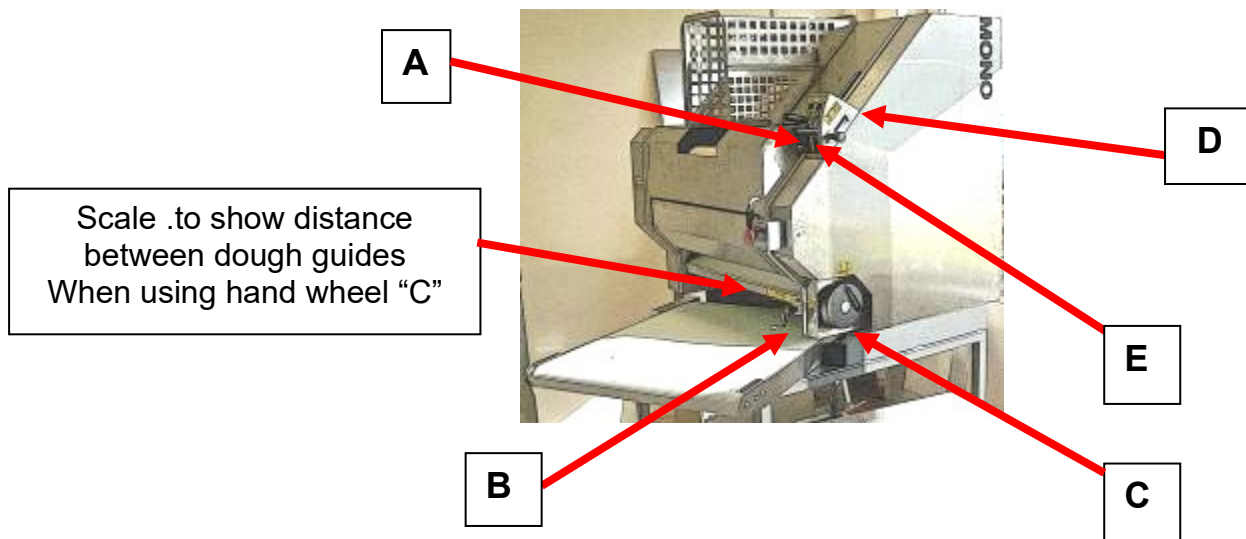

- 3 **Adjust handle "B"** for the pressure board.  
*Anti-clockwise will mean the numbers on the digital counter will increase and therefore the pressure on the dough will decrease. Clockwise will be the opposite. The number on the digital counter should be noted so it can be reproduced at a later date.*
- 4 **Adjust hand wheel "C"** to control the length of the loaf.  
*Hand wheel simultaneously positions the dough side guides equally about the centreline of the moulder. The distance between the dough guides is indicated by the metal pointer and the scale*
- 5 After moulding, the dough piece should be transferred from the offtake to a waiting tray.

# 10.0 MAINTENANCE

---



- WARNING**
- This appliance must be maintained at regular intervals. The frequency of maintenance will depend upon your specific use and location. The maximum service interval should be 12 months.
  - Service and maintenance should only be undertaken by suitably qualified, trained, and competent engineers.
  - You must immediately report any damage or defect arising with the appliance.
  - Unsafe equipment is dangerous. Do not use the appliance. Isolate the power supply and contact MONO or your appointed service agent.
- 



- WARNING**
- Isolate the Divider from the mains supply before attempting any maintenance operations.
- 

- 1 Refer to cleaning instructions.
- 2 It is recommended that the bearings, chain, motor, etc. be greased every six months
- 3 If a belt is tracking to the left or the right. Call in maintenance contractor immediately before any permanent damage can occur.

## MAINTENANCE ENGINEER NOTES

Moulding belts should be no tighter than necessary to eliminate slippage. Over tensioning can lead to belt and/or bearing failure. The belt should be adjusted by means of the adjustment tensioning screws (shown below).

The belts should run with equal clearance between its edges and the unit side frames. If one edge of the belt is tighter than the other, it will tend to run towards the slack side. This tracking defect can be eliminated by individual adjustment of the tensioning screws.

### Caution

Adjustment screws should not be continually tightened (this will cause bearing failure or the moulding belt to stretch and break). It may be that one side is too tight so should be eased off a little.

Bearings and bearing grub screws (2 per bearing) should also be checked as a seized bearing may be the cause of the moulding belt needing adjustment.

If a bearing is replaced, the grub screws should be tightened and liquid thread lock applied.

(On later models the grub screws should also be aligned with dimples in the roller shaft).



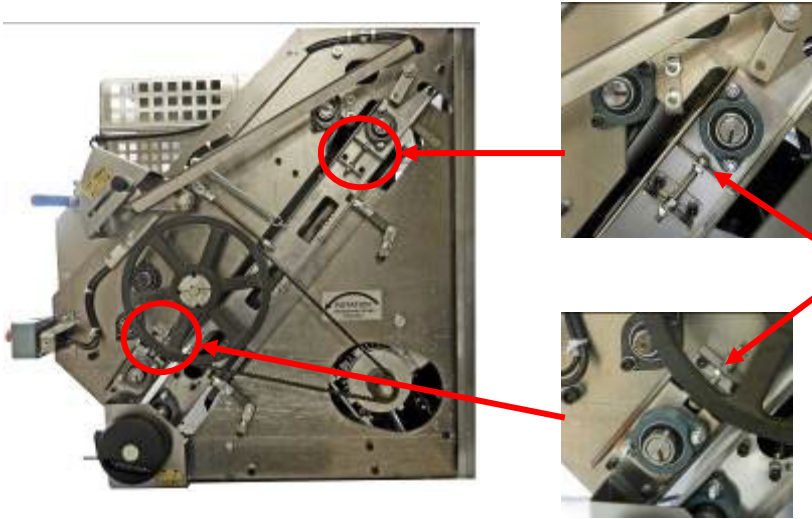

ADJUSTMENT TENSIONING  
SCREWS  
(one side shown.)

# 11.0 TROUBLESHOOTING

---

- ✓ The final dough temperature, after mixing, should not exceed the ideal. (typically 25 - 26 ° C)
- ✓ A dough conditioner containing a good relaxant is required.
- ✓ French dough should be soft but not sticky.
- ✓ Curling chain should be kept clean.

## 12.0 SERVICE AND SPARES ---

If a fault arises, please do not hesitate to contact the Customer Service Department, quoting the **machine serial number** on the silver information plate of the machine and on the front cover of this manual

### SPARES and OVERSEAS SUPPORT:



**MONO**

Queensway  
Swansea West Industrial Estate  
Swansea. SA5 4EB UK

**email: [spares@monoequip.com](mailto:spares@monoequip.com)  
Web site: [www.monoequip.com](http://www.monoequip.com)**

**Tel. spares +44(0)1792 564039  
switchboard +44(0)1792 561234  
Fax. 01792 561016**

# “V” BELT AND DRIVE INFORMATION

DUE TO CONTINUAL IMPROVEMENTS  
METALWORK MAY BE SLIGHTLY  
DIFFERENT ON THE MODEL YOU HAVE

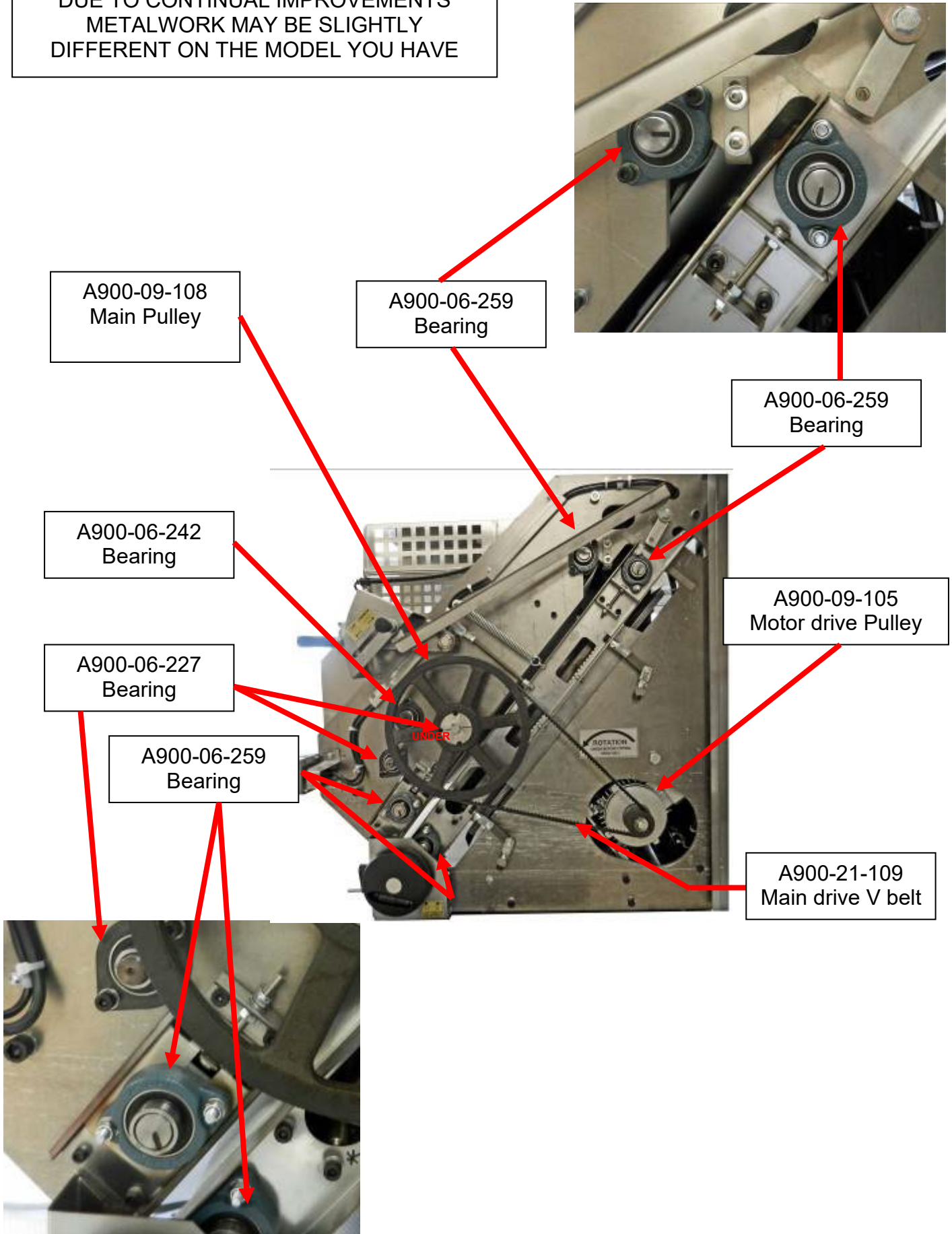

# MOULDING BELT DRIVE INFORMATION

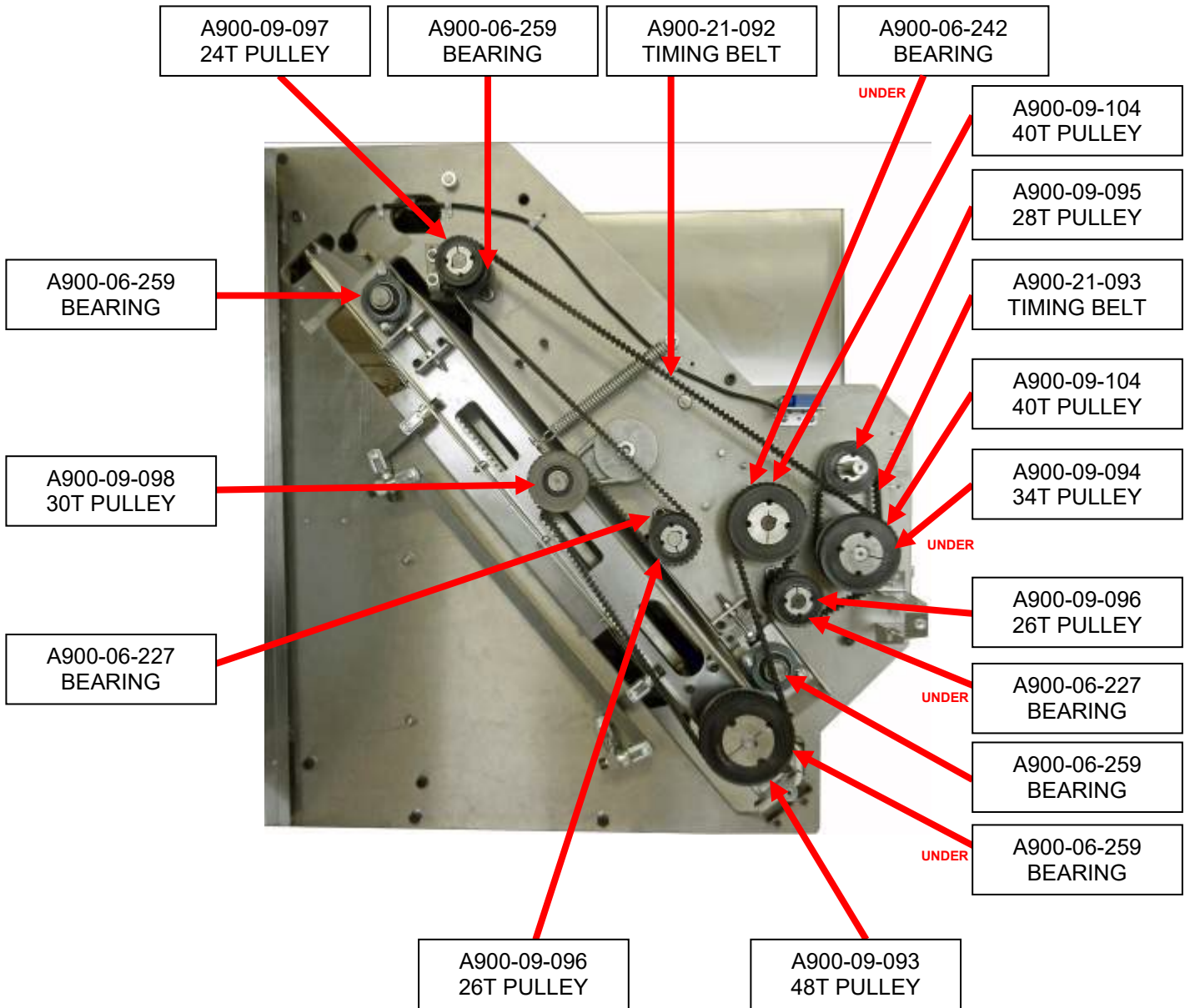

		PART NO.
<b>PULLEY</b>	48T	A900-09-093
	34T	A900-09-094
	28T	A900-09-095
	26T	A900-09-096
<b>BELT -- DOUBLE SIDED LARGE -- TIMING BELT</b>		A900-21-092
		A900-21-093

# 13.0 MOULDER ELECTRICALS

---



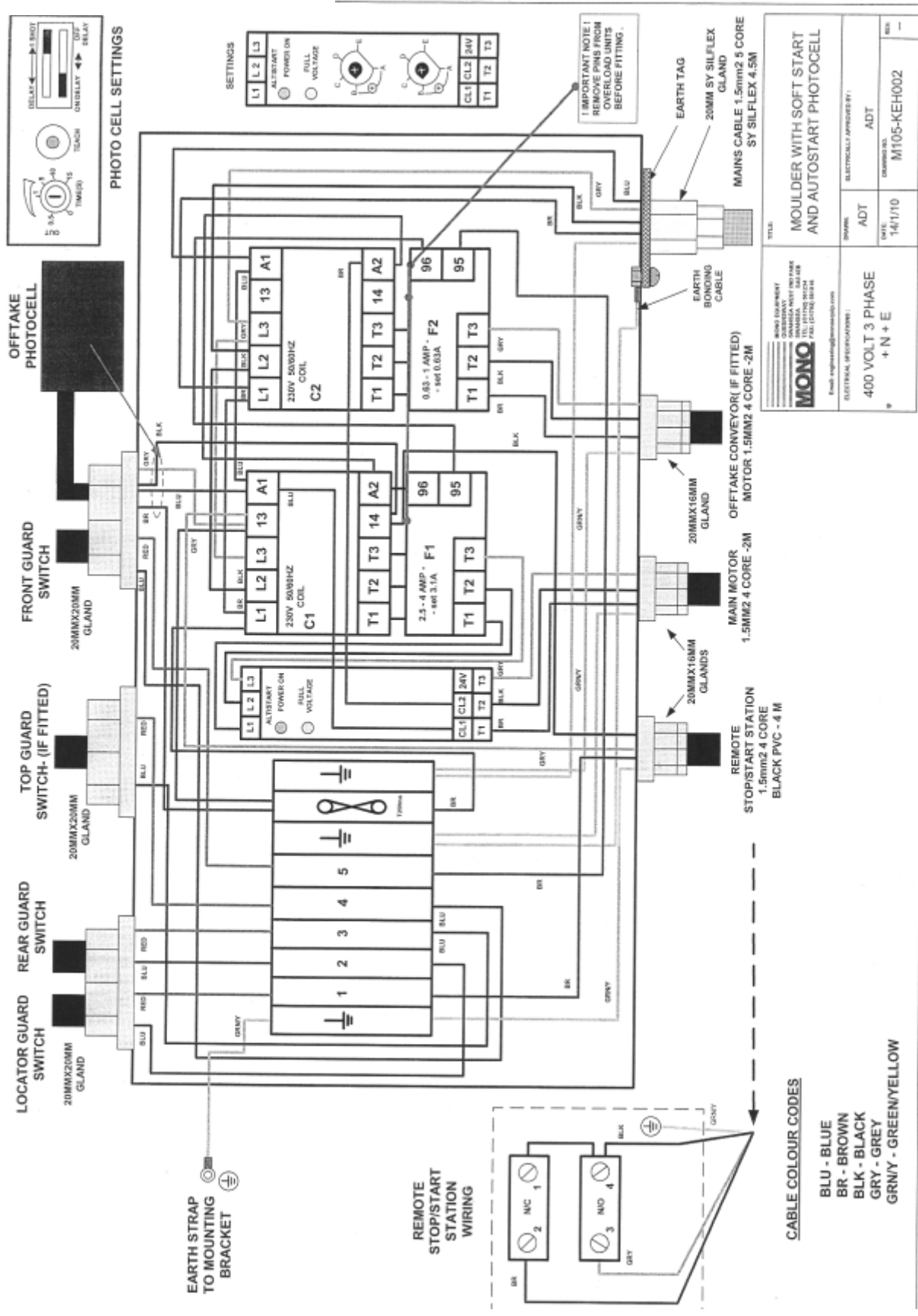

# SECTION 4



FULL OPERATING AND MAINTENANCE  
MANUAL  
FOR THE  
**BREADPLANT CONICAL ROUNDER**



# CONTENTS ---- ROUNDER SECTION

1.0	INTRODUCTION .....	114
2.0	OVERALL DIMENSIONS .....	114
3.0	SPECIFICATIONS .....	115
4.0	SAFETY .....	116
5.0	INSTALLATION .....	117
6.0	ISOLATION .....	118
7.0	CLEANING .....	119
8.0	OPERATING CONTROLS .....	120
9.0	TROUBLESHOOTING .....	121
10.0	SPARES AND SERVICE .....	122

---

**FOR SERVICE AND SPARES RING: 01792 564044**

---

11.0	MOULDER ELECTRICAL INFORMATION .....	123
12.0	MAINTENANCE .....	126

**Failure to adhere to the cleaning and maintenance instructions detailed in this booklet could affect the warranty of this machine**

# 1.0 INTRODUCTION

---

The conical rounder produces consistently shaped dough pieces for the intermediate prover of the Mono Fusion “Pro” models.

Fed from the divider, it forms perfectly rounded dough pieces with the help of a flour duster and gently blown air, before passing them on to the prover.

Parts are Teflon coated or stainless steel, making the rounder easy to keep clean

# 2.0 DIMENSIONS

---

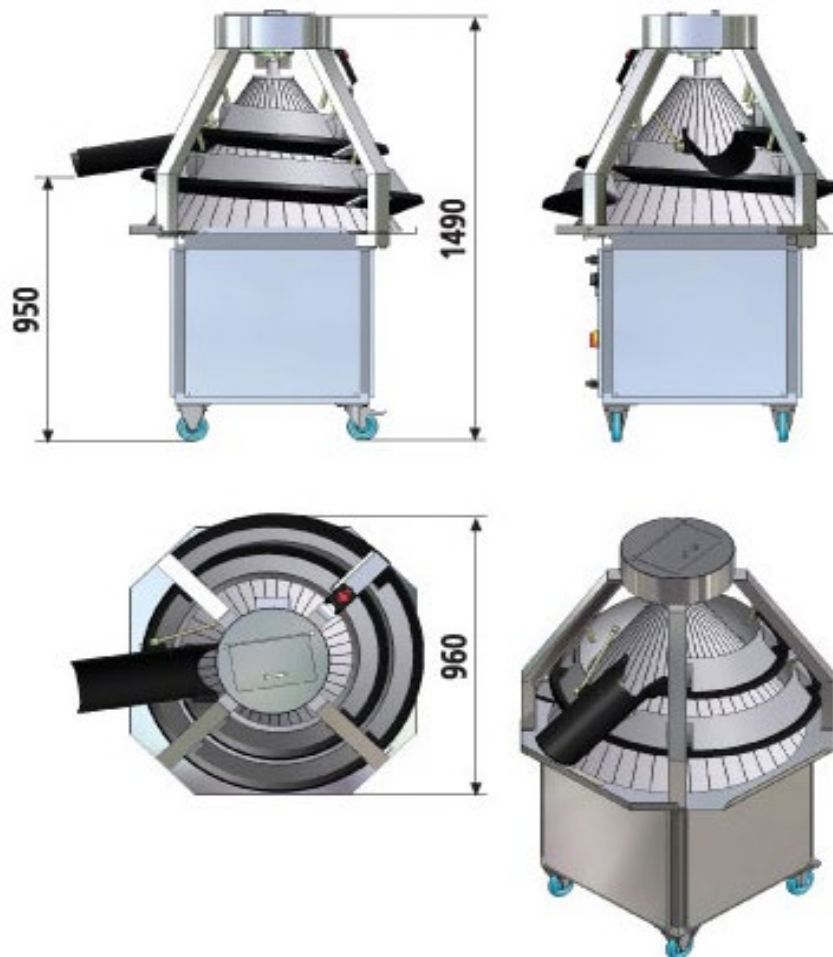

## 3.0 SPECIFICATIONS

---

**CAPACITY:** Dough piece weight range – 100grms to 1200grms

**OUTPUT:** Up to 960 pieces per hour

**LENGTH OF  
ROUNDING TRACK:** 3 Metres

**POWER:** 0.55kW 220/380 VAC

**WEIGHT:** 205kg

**NOISE LEVEL:** Less than 85d

## 4.0 SAFETY



- 1 **Never use a machine in a faulty condition** and always report any damage.
- 2 **No-one under the age of 16 may operate** this machine.
- 3 **No-one under the age of 18 may clean** this machine under any circumstances.
- 4 **Only trained personnel may remove any part** from this machine that requires a tool to do so.



- 5 **Always ensure hands are dry** before touching any electrical appliance (including cable, switch and plug).

- 6 **All operatives must be fully trained.**

- 7 People undergoing training on the machine must be under direct supervision.



- 8 **Do not operate the machine with any panels removed.**

- 9 **All guards must be fixed in place with bolts or screws** unless protected by a safety switch.

- 10 **No loose clothing or jewellery** to be worn while operating the machine.

- 11 **Switch off power at the mains isolator when machine is not in use** and before carrying out any cleaning or maintenance.

- 12 The Bakery Manager or the Bakery Supervisor must carry out daily safety checks on the machine.



**ALL OTHER CLEANING AND MAINTENANCE OPERATIONS MUST BE MADE WITH MACHINE DISCONNECTED FROM THE POWER SUPPLY**



**DO NOT ATTEMPT TO CLEAN THE MOULDING AREAS WHEN THE MACHINE IS RUNNING**



**DO NOT INSERT HANDS INTO FLOUR DUSTER WHEN THE MACHINE IS RUNNING**

### **WARNING:**



Hand or bodily contact with moving surfaces may cause friction burns to skin.  
This situation need not occur to successfully operate the moulder

## 5.0 INSTALLATION

---

- 1 The rounder should be placed in position or connected to the prover using the locator, if fitted.
- 2 Set the brake castors on to stop the rounder moving.
- 3 Plug the power lead into the correct socket on the prover.
- 4 Check the machine after installation to ensure the cone runs in the right direction (see direction of arrow below). This should be done by “inching” the motor.

(This should have been correctly set at the factory, but if the machine is a replacement, this should be checked)

If the motor rotation is incorrect, transpose any two wires of the three phase carrying wires.



**CONE  
DIRECTION**

- 5 Ensure machine is standing level on a solid floor.

## 6.0 ISOLATION

---

In an emergency, switch off the plant at the wall isolator, the main isolator on the front of the rounder or the emergency stop button shown below.

### EMERGENCY STOP BUTTON

To release stop button after use, twist and release.



### MAIN ISOLATOR SWITCH

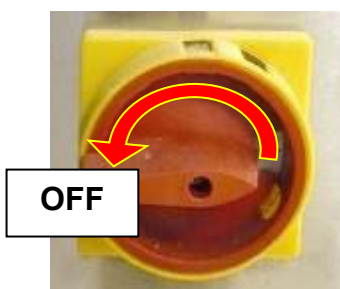

## 7.0 CLEANING

---



**SWITCH OFF AND ISOLATE MACHINE FROM MAINS SUPPLY BEFORE COMMENCING CLEANING**

**Every day:**

All dough touching surfaces should be cleaned every day.

Don't use steel scrapers and poisonous chemicals or soap for cleaning purposes.

**Every week:**

Outer sides should be cleaned by a wet cloth.

Scrape and scrub wheels clean as needed.

**DANGER:**

Cleaning operations should only be carried out with the machine switched off and disconnected from the electric power supplies.

**BEWARE:**

Don't use jets of water to clean.

The control panels and the electric control box should be kept dry.

Don't use solvents, which could damage the paint and synthetic materials.

# 8.0 OPERATING CONTROLS



<b>EMERGENCY STOP</b>	
Push to operate. Turn and release to reset.	
<b>ON BUTTON</b>	
<b>COLD / HOT AIR SWITCH</b>	



<b>SPEED CONTROL</b>
This allows the rounding speed to be adjusted to match other machines if needed.

## FLOUR DUSTER



Open lid and insert dry flour as required.  
Close lid.



**MOULDING DUSTER**

**CHUTE DUSTER**



MOVE DUSTER CONTROL PLATES TO CONTROL THE FLOUR IN THE AREA REQUIRED. THE MORE HOLES SHOWING, THE MORE FLOUR FLOWS



## 9.0 TROUBLESHOOTING

---

This section deals with some of the most common problems that can arise during the machine operation.

**NOTE:** Please contact the after sales service for any other problems not mentioned in the following list or in the event of malfunctioning which still persists after the suggested action has been taken.

PROBLEM	POSSIBLE CAUSE	SOLUTION
When the start button is pressed, the machine does not start.	<ul style="list-style-type: none"><li>-Flour lid is open</li><li>-Emergency button has been pressed.</li><li>-Thermal relay has intervened to protect the system.</li><li>-Main plant not connected to power supply</li></ul>	<ul style="list-style-type: none"><li>- Close the flour lid</li><li>- Reset the emergency stop button by turning and releasing.</li><li>- Reset the thermal relay and find out why the machine has overheated.</li><li>- Connect plant to supply</li></ul>

## 10.0 SERVICE AND SPARES ---

If a fault arises, please do not hesitate to contact the Customer Service Department, quoting the **machine serial number** on the silver information plate of the machine and on the front cover of this manual

### **MONO**

**Queensway  
Swansea West Industrial Estate  
Swansea.  
SA5 4EB  
UK**

**email: [spares@monoequip.com](mailto:spares@monoequip.com)  
Spares Tel. +44(0)1792 564039**

**Web site: [www.monoequip.com](http://www.monoequip.com)**

**Main Tel. 01792 561234  
Fax. +44(0)1792 561016**

# 11.0 ELECTRICAL INFORMATION —



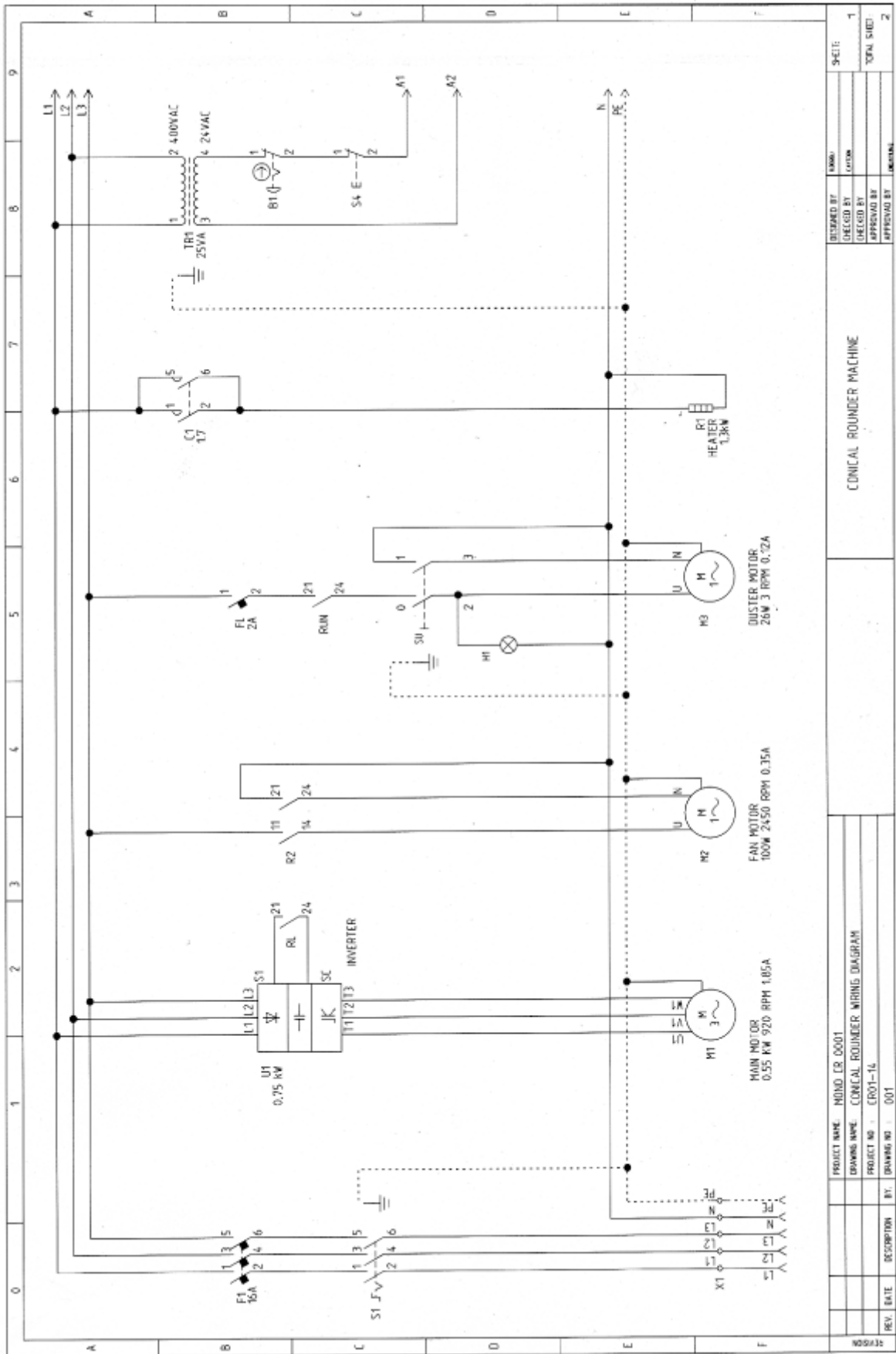

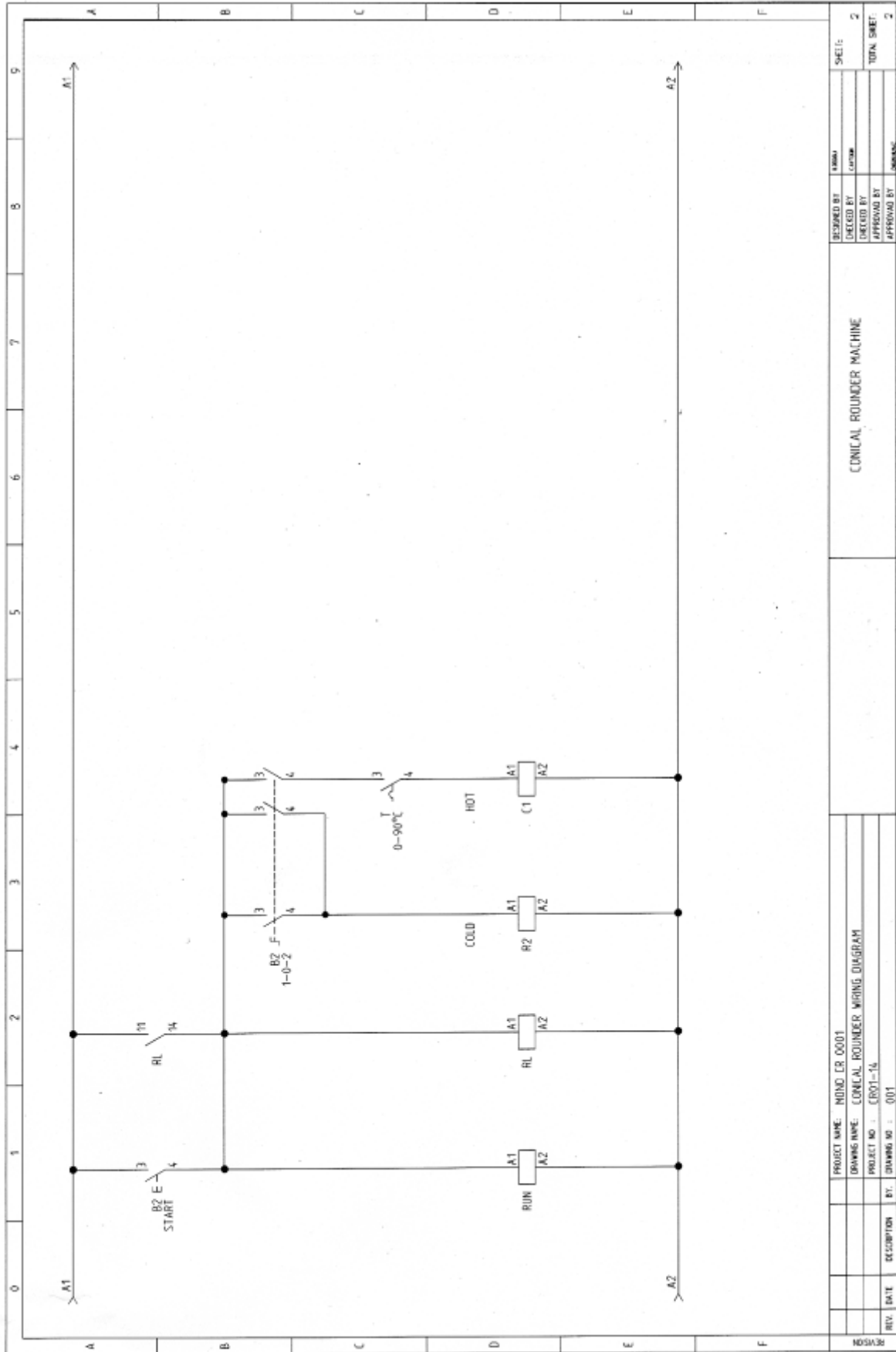

DESIGNED BY	YASMIN	SHEET:	2
CHECKED BY	LORENA	TOTAL SHEET:	2
APPROVED BY			
APPROVED BY			

PROJECT NAME: MONO ER 0001	
DRAWING NAME: CONICAL ROUNDER WIRING DIAGRAM	
PROJECT NO.: CRO1-14	
DRAWING NO.: 001	

REVISION	DATE	DESCRIPTION	BY

## 12.0 MAINTENANCE

---



### WARNING

- This appliance must be maintained at regular intervals. The frequency of maintenance will depend upon your specific use and location. The maximum service interval should be 12 months.
- Service and maintenance should only be undertaken by suitably qualified, trained, and competent engineers.
- You must immediately report any damage or defect arising with the appliance.
- Unsafe equipment is dangerous. Do not use the appliance. Isolate the power supply and contact MONO or your appointed service agent.



### WARNING

- Isolate the machine from the mains supply before attempting any maintenance operations.
-





Queensway  
Swansea West Industrial Estate  
Swansea.  
SA5 4EB  
UK

[email:spares@monoequip.com](mailto:spares@monoequip.com)  
[Web site:www.monoequip.com](http://www.monoequip.com)

**Tel. 01792 561234**  
**Fax. 01792 561016**

FOR SERVICE AND SPARES RING: **01792 564044**

**DISPOSAL**

**CARE SHOULD BE TAKEN WHEN THE MACHINE COMES TO THE END OF ITS WORKING LIFE. ALL PARTS SHOULD BE DISPOSED OF IN THE APPROPRIATE PLACE, EITHER BY RECYCLING OR OTHER MEANS OF DISPOSAL THAT COMPLIES WITH LOCAL REGULATIONS.**

**(IN UK, ENVIRONMENTAL PROTECTION ACT 1990 APPLIES)**

**DISPOSE OF UNUSED PRODUCT AND CONTAINERS  
CAREFULLY AND RESPONSIBLY**