

# MONO DX Classic Deck Oven

EN

## Installation and Operation Manual



### Product Version

- UK specification
- Classic control
- Fixed standard-depth decks

Enter Serial Numbers here

Deck 1
Deck 2
Deck 3
Deck 4
Deck 5
Fan (If fitted)

In the event of an enquiry please quote these serial numbers.



## DECLARATION OF CONFORMITY

We hereby declare that this machine complies with the essential health and safety requirements of :-

- The Machinery Directive 2006 / 42 / EC
- The Low voltage Directive 2006 / 95 / EC
- The requirements of the Electromagnetic Compatibility Directive 2004 / 108EC, 91 / 263 / EEC, 92 / 31 / EEC
- The General Safety of Machinery and food processing Standards applicable
- Materials and Articles intended to come into contact with food - Regulation (EC) No. 1935 / 2004
- Good manufacturing practice for Materials intended to come into contact with food - Regulation (EC) No. 2023 / 2006

<b>Signed</b>	
<b>D. Osmundsen – Quality and Conformance Manager</b>	

<b>Date</b>	
-------------	--

<b>Machine FG Code.</b>		<b>Machine Serial No.</b>	
-------------------------	--	---------------------------	--

A technical construction file for this machine is retained at the following address:

**MONO EQUIPMENT**  
Queensway,  
Swansea West Industrial Park,  
Swansea  
SA5 4EB  
UK

**MONO EQUIPMENT** is a business name of **AFE GROUP Ltd**  
Registered in England No.3872673 VAT registration No.923428136

Registered office: Unit 35,  
Bryggen Road,  
North Lynn Industrial Estate,  
Kings Lynn Norfolk,  
PE30 2HZ

## Safety symbols

The following safety symbols are used throughout this document and manual (available at [www.monoequip.com](http://www.monoequip.com)). Before using your new equipment, read the instruction manual carefully and pay special attention to information marked with the following symbols



**WARNING** Indicates a hazardous situation that, if not avoided, could result in death or severe injury.



**WARNING** Indicates a hazardous situation that, if not avoided, could result in death or severe injury.



**CAUTION** Indicates a hazardous situation that, if not avoided, could result in minor or moderate injury.



## Electrical safety and advice regarding supplementary electrical protection

Commercial bakeries, kitchens and food service areas are environments where electrical appliances may be located close to liquids, or operate in and around damp conditions, or where restricted movement for installation and service is evident.

The installation and periodic inspection of the appliance should only be undertaken by a qualified, skilled and competent electrician, and connected to the correct supply suitable for the load as stipulated by the appliance data label.

The electrical installation and connections should meet the necessary requirements of the local electrical wiring regulations and any electrical safety guidelines.

### We Recommend:

- Supplementary electrical protection with the use of a residual current device (RCD)
- Fixed wiring appliances incorporate a locally situated switch disconnecter to connect to, which is easily accessible for switching off and safe isolation purposes. The switch disconnecter must meet the specification requirements of IEC 60947.

### Your attention is drawn to:

#### **BS 7671:2018 – Guidance Note 8 – 8.13 : Other locations of increased risk**

It is recognised that there may be locations of increased risk of electrical shock other than those specifically addressed in Part 7 of BS 7671. Examples of such locations could include laundries where there are washing and drying machines in close proximity, and water is present, and commercial kitchens with stainless steel units, where once again, water is present. Where, because of the perception of additional risks being likely, the installation designer decides that an installation or location warrants further protective measures, the options available includes:

- Automatic Disconnection of Supply (ADS) by means of a residual current device having a residual operating current not exceeding 30 mA;
- Supplementary protective equipotential bonding; and
- Reduction of maximum fault clearance time.

The provision of RCDs and supplementary bonding must be specified by the host organisation's appointed installation designer or electrical contractor and installed by a suitably qualified and competent electrician so as to comply with Regulations 419.2 and 544.2.



The supply to this machine must be protected by a **30mA Type A RCD**



## Important safety matters: fix a water leak immediately to help prevent electrocution

It is essential to regularly check for any signs of a water leak from an oven installation. If there is evidence of a water leak, do not ignore it. Immediately report it to a manager or as applicable to your organisation.

Furthermore:

- Isolate the oven from the electrical supply (see **Chapter 5**).
- Place an out-of-service notice on the oven.
- Contact MONO Equipment for assistance (see **Back Page**).

Ovens need to be maintained and serviced at appropriate intervals to help prevent water leaks from the internal plumbing and external hose connections. See **Chapter 13** for maintenance information.

## Important notes

---

**WARNING**

- An electrical socket must be protected by a 30mA Type A Residual Current Device (RCD) before installation and commissioning of the oven.
  - To reduce the risk of fire or electric shock, do not remove covers (or back sheeting). There are no user-serviceable parts inside. Repairs should be done by authorised personnel only.
  - Never use the USB port to power or recharge electronic devices e.g., mobile phones. Incorrect usage causes damage to the oven and could result in a fire.
- 

**WARNING**

- Be aware of hot surfaces.
    - Do not touch the front with bare skin.
  - Failure to adhere to the cleaning and maintenance instructions detailed in this manual could affect the warranty of this machine.
  - The oven should only be used for baking bread, pastries, and cakes.
  - Some sections of this manual are for engineers only and the customer should not attempt to make any alterations.
-

# Contents

	Page
<b>1. Introduction</b> .....	<b>8</b>
<b>2. Specifications</b> .....	<b>9</b>
Specifications sheet.....	9
Environmental specifications .....	10
Overall dimensions .....	10
<b>3. Safety</b> .....	<b>11</b>
<b>4. Installation</b> .....	<b>12</b>
General .....	12
Electrical connections .....	12
Water supply requirements .....	12
Oven water system setup procedure .....	13
Exhaust Connections (if canopy fitted) .....	15
<b>5. Isolation</b> .....	<b>17</b>
<b>6. Cleaning</b> .....	<b>18</b>
Daily cleaning instructions.....	18
Weekly cleaning instructions.....	18
<b>7. Operating Conditions</b> .....	<b>19</b>
<b>8. Principle of Oven Operation</b> .....	<b>19</b>
Baking heat .....	19
Steaming function .....	19
Baking advice .....	20
<b>9. Operation instructions</b> .....	<b>21</b>
Basic operation.....	22
Firmware update using the i-BUTTON .....	25
Operating the oven.....	26
Setting the day and time .....	27
Setting the 7-day timer.....	28
Setting mode.....	29
<b>10. Troubleshooting</b> .....	<b>31</b>
<b>11. Service and Spares</b> .....	<b>32</b>
Service Information.....	32
<b>12. Maintenance</b> .....	<b>33</b>
General maintenance .....	33
<b>13. Electrics</b> .....	<b>34</b>

# 1. Introduction

The electric DX Deck Oven is an easy-to-use practical, good-looking oven, giving an excellent heat recovery rate and an even bake across a wide range of bread and confectionery products.

*Good looking and completely reliable*

Conceived with the no-nonsense requirements of both the independent and in-store baker in mind, designed to be visually pleasing and give reliable service for many years visually. This oven will more than satisfy the most discerning customer.

*Top-quality specification*

External and internal contact surfaces are stainless steel, so there's no fear of deterioration even after many years of hard use; plus, each deck is fitted with baking sheets manufactured from natural materials as a standard fitting.

The oven comes with an integral steaming system, which reduces energy consumption and the overall size of the oven. The system produces natural steam with all the advantages of spray steam, and you can enjoy it time and time again because rapid recovery has been designed into the oven. No drainage is required.

Classic ovens are supplied with **LED** displays. All programmable parameters have separate indicators for easy programming and extra bake time, if required. An energy saving 7-day timer is also standard. An i-button can be used to upgrade firmware without the need of dismantling the panels.

Simplified electrical circuits aid reliability with overheat protection (on controllers and oven) to ensure long life of controllers, all housed in splash-proof electrical enclosures.

Fitted with hinged easy to clean doors, individual top and bottom heat controls and seven day bake timers for each deck, the oven gives the Master Baker a fast, even bake.

**As it is our policy to improve our machines continuously, we reserve the right to change specifications without prior notice.**



# 2. Specifications

## Specifications sheet



**WARNING** ■ An electrical socket must be protected by a 30mA Type A Residual Current Device (RCD) before installation and commissioning of the oven.

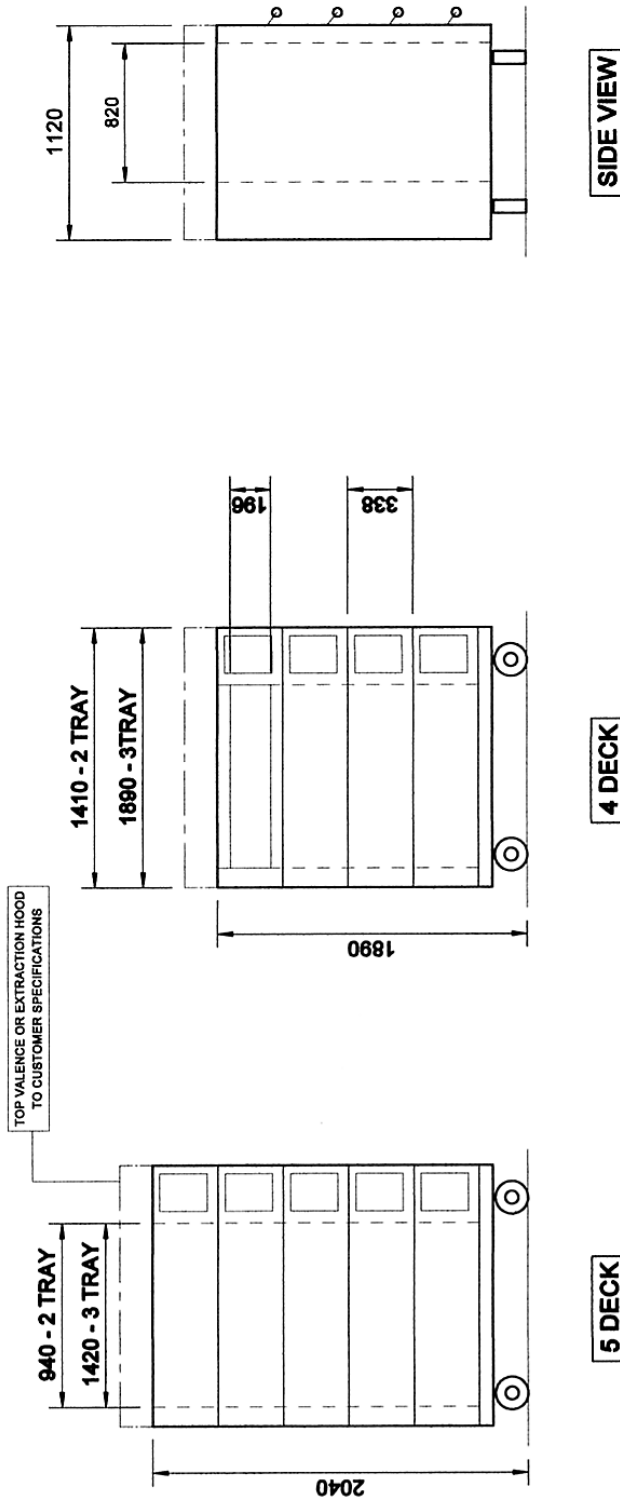

NOMINAL TRAY WIDTH	EXTERNAL AREA	POWER Kw (PER DECK)		VOLTAGE AS REQUIRED IN THE COUNTRY OF USE	INTERNAL SURFACE AREA	No. OF TRAYS (per deck)
		5 DECK	4 DECK			
3 tray	2.12Mtr <sup>2</sup>	8.24	8.24		1.1Mtr <sup>2</sup>	600 X 800 800 X 400 18" X 30" (457 X 760) 18" X 26" (457 X 660)
2 tray	1.58Mtr <sup>2</sup>	NOT AVAILABLE	NOT AVAILABLE		0.7Mtr <sup>2</sup>	600 X 800 800 X 400 18" X 30" (457 X 760) 18" X 26" (457 X 660)

### MONO DX11 OVEN RANGE

## Environmental specifications

The noise level is less than 80 dB.

## Overall dimensions

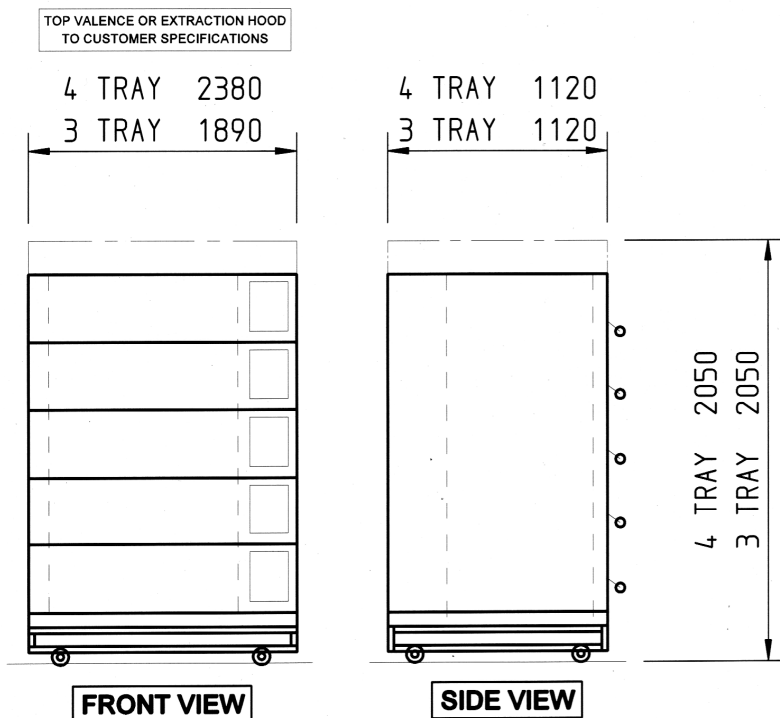

**Note:** All dimensions are in mm and are approximated.

### 5 DECK    3 TRAY

HEIGHT    2040 mm  
WIDTH     1890 mm  
DEPTH    1120 mm

### 5 DECK    2 TRAY

HEIGHT    2040 mm  
WIDTH     1410 mm  
DEPTH    1120 mm

### 4 DECK    3 TRAY

HEIGHT    1890 mm  
WIDTH     1890 mm  
DEPTH    1120 mm

### 4 DECK    2 TRAY

HEIGHT    1890 mm  
WIDTH     1410 mm  
DEPTH    1120 mm

## 3. Safety

The Bakery Manager or Supervisor must carry out daily safety checks. Bakery staff **must not**, under any circumstances, remove panels to access any part of the oven.

Only fully-trained and authorised persons are permitted to do any work on the oven. Authorised electricians must carry out all repairs and maintenance of electrical units. Always disconnect or isolate the power supply before starting any maintenance (i.e. opening panels) or cleaning work on the oven.



### Warning!

- Before using the oven, check that:
  - All cover panels and pipe fittings are secure.
  - The door handles are not damaged.
- If the oven is damaged or malfunctioning, stop using it.
  - Do not attempt any repairs.
  - Contact the Mono Service Department for advice.
  - Fit only **MONO** spare parts to this oven.
- All connections to the oven must comply with the statutory requirements of the country of installation.
- Never use the USB port to power or recharge electronic devices e.g., mobile phones. Incorrect usage causes damage to the oven and could result in a fire.
- Operate the oven only as described in this manual.



### Warning!

- Separate electrical supplies to each deck and the prover base must have their own 30mA Type A Residual Current Device (RCD).
- Always fit a wall isolator to isolate the oven completely. The isolator must be visible, labelled, and easily accessible by an operator.
- Always check the electrical ratings on the nameplate before connecting power.



### Caution!

- Be aware of hot surfaces:
  - Always use oven gloves when loading or unloading the oven.
  - Allow time for the oven to cool down before cleaning it. To prevent door glass from shattering, do not clean the oven glass when hot.
  - While the oven is in operation (and for some time after use), it is inadvisable to touch the oven window or the surrounds because of conducted heat.
- The oven owner is legally obliged to instruct staff on these safety points and the safe operation of the oven. Therefore, these instructions should not be removed from the working area.
- Do not store items on top of or behind the oven.
- Only use the oven for baking bread, pastries, and cakes. Contact Mono Equipment for other product-making machines.
- No unauthorised modifications to the oven are permitted.

## 4. Installation

### General

- A hard and smooth level floor is recommended on which to position the oven. Access for maintenance should be considered.

The oven is not designed to be "built-in". Sufficient clearance must be left in front of the access panels (right hand side) to allow for servicing.

- If not chosen as an oven option, it is recommended that an extraction hood be placed above the oven to disperse excess steam and heat, which could have an adverse effect on the bakery ceiling and ambient temperature.
- A chain retainer should be fitted, that is shorter than the power cables, to protect them from strain if the oven is moved. (Fit to the wall or floor and the base, using hole provided in castor fixing corner plates).
- Installation must be made by a trained authorised engineer and all utilities must conform to all local regulations.

### Electrical connections

- The main connection point for all deck supplies is at the top of the oven.
- Read the **Safety** section on **page 18**.
- Electrical loadings are in the **Specifications** section.

### Water supply requirements

#### Oven

- All ovens with a steam function require a ¾" BSP hot or cold water supply at a pressure of 2 - 3 bar (29 – 44 psi). The water supply should comply with local water regulations.
- A manifold supplies all decks from one connection point.
- For proper operation of the steam system, it is recommended that the water supply also has the following specifications:

<b>Hardness</b>	0 – 4 grains per gallon
<b>PH range</b>	7.0 to 8.5
<b>Chloride concentration</b>	0 – 20 ppm

**Consult Mono for proper water filtration system information.**

- No drain is required for this oven.
- A non-return check-valve is supplied fitted to the water inlet manifold.

---

#### NOTE

The set-up procedure below must be followed to allow the steaming system to function correctly.

---

## Oven water system setup procedure



It is imperative that the water delivery to the deck oven is checked for the steam system to operate correctly.

Note that dynamic pressure, not static pressure, is being measured.

### Procedure

1. Flush out the main feed pipe to be used until water runs clear and free from debris.
2. Connect the main feed to the oven.
3. Place a container under the test valve.
4. Slowly open drain valve and set the regulator to 0.5 bar using the screw underneath.
  - Never use the oven above this setting.
5. When the pressure has stabilised, shut the test valve.
6. Repeat steps 3 to 6 at the end of the installation.

Figure 1: Water regulator setup (located on rear of oven)

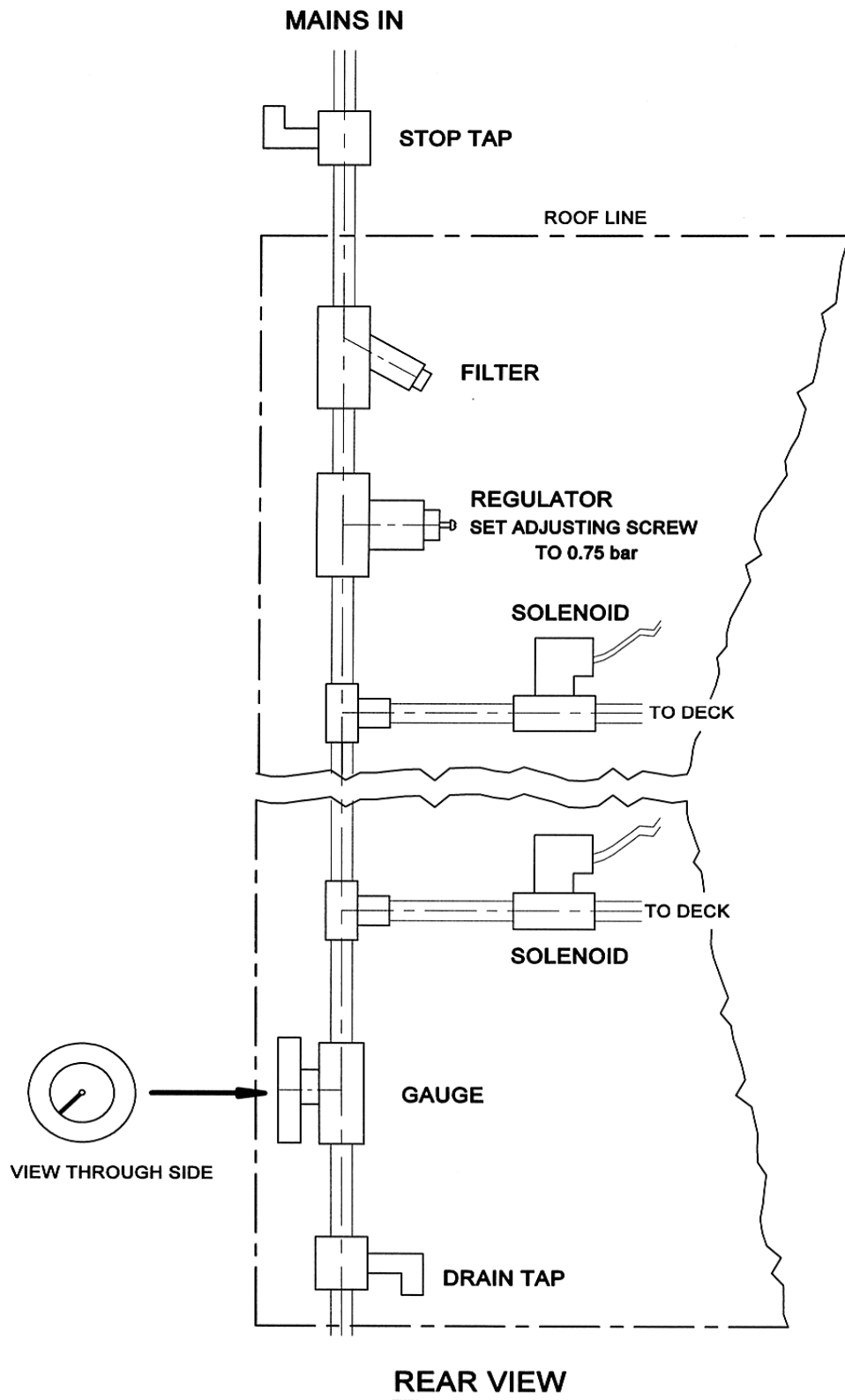

## Exhaust Connections (if canopy fitted)

- Ideally, an exhaust duct should rise 2 metres above the bakery roof and be protected from wind and birds by a duct protector.
- It should be of a suitable material to take the high temperatures and humidity expected.
- It should be flexible and easily removable at the oven connection point.  
*This allows the oven to be moved for cleaning when required.*

**Figure 2:** Canopy (without fan) dimensions

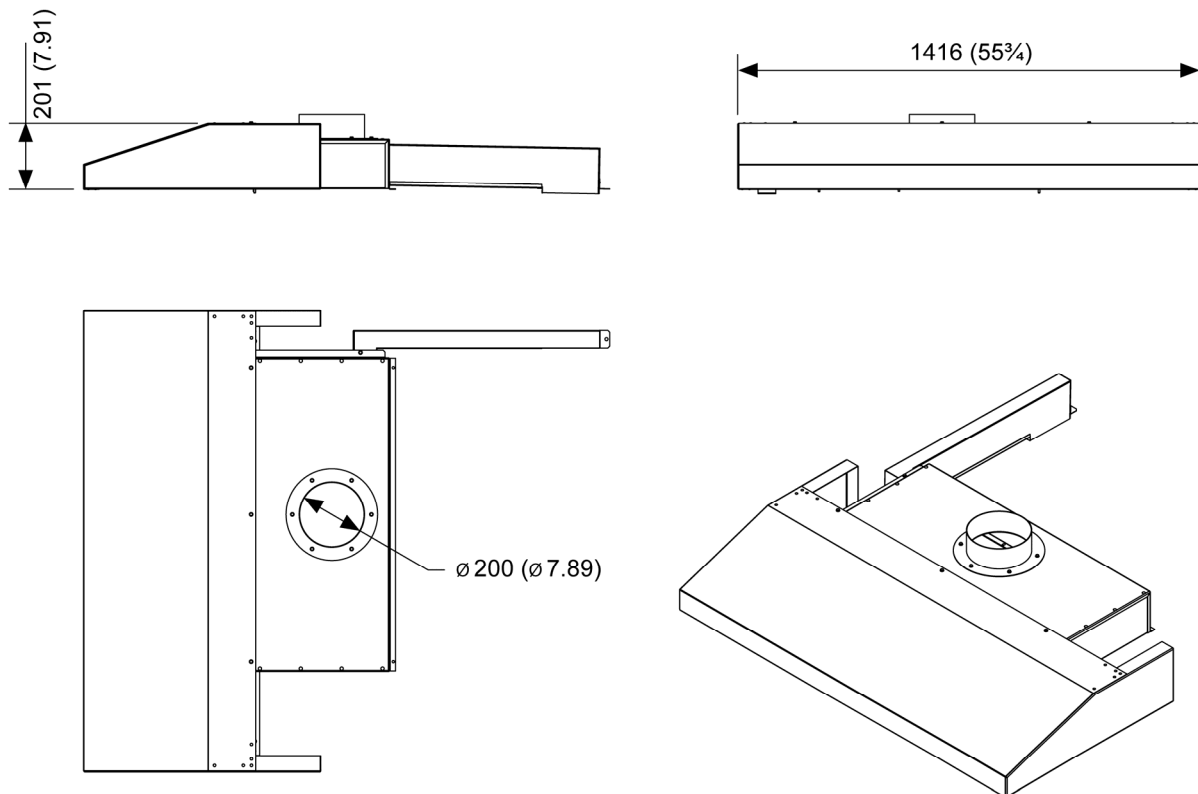

Dimensions are in mm (inches)

**Figure 3:** Canopy (with fan) dimensions

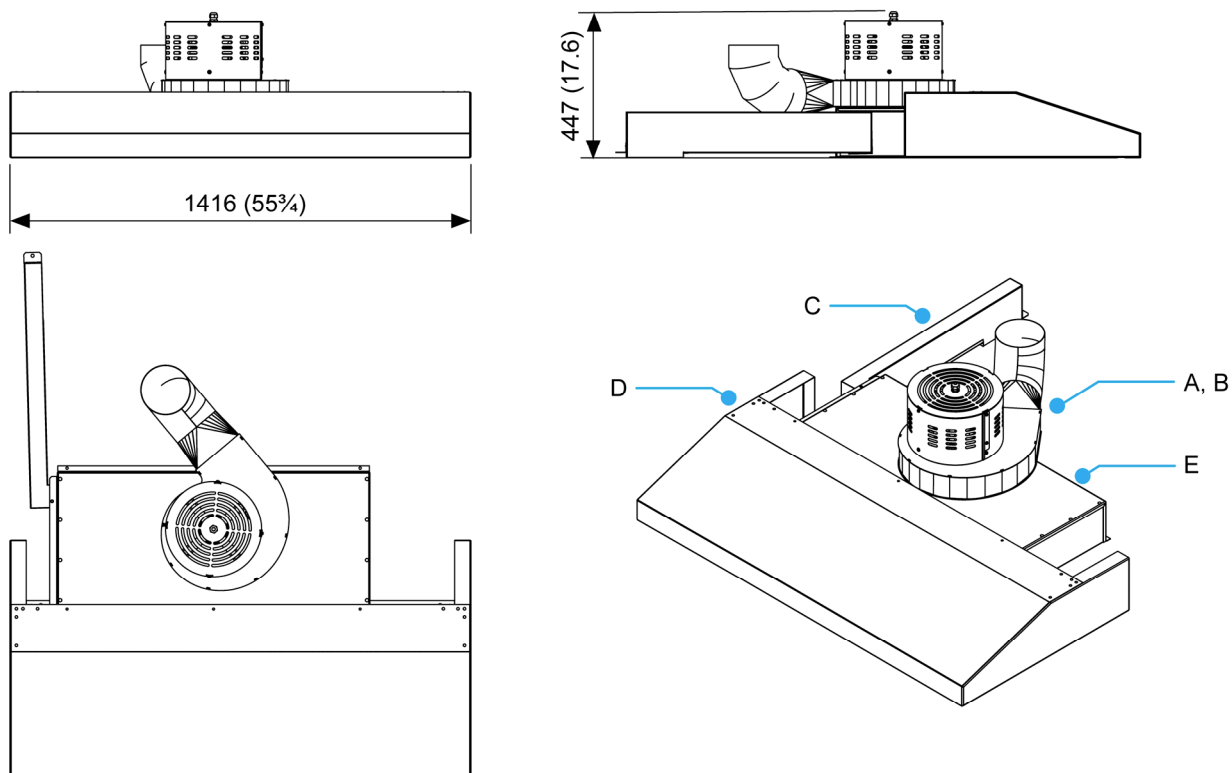

Dimensions are in mm (inches)

**Table 1:** Canopy parts

Item		Part number
A	Extraction fan assembly	247-08-04900
B	Inlet ring	247-08-05100
C	Flue assembly	257-10-00010
D	Canopy assembly	257-10-00016
E <sup>(1)</sup>	Extraction duct assembly for 2-tray oven width	257-10-00022

<sup>(1)</sup> Contact MONO Equipment for the availability of other extraction duct assemblies.



# 5. Isolation

**To stop the oven in an emergency, switch off at the main isolator.**

A wall-mounted isolator switch, rated for the specific model of oven installed, must also be available to isolate the oven completely in an emergency. The isolator must be clearly accessible and known to the oven operator.

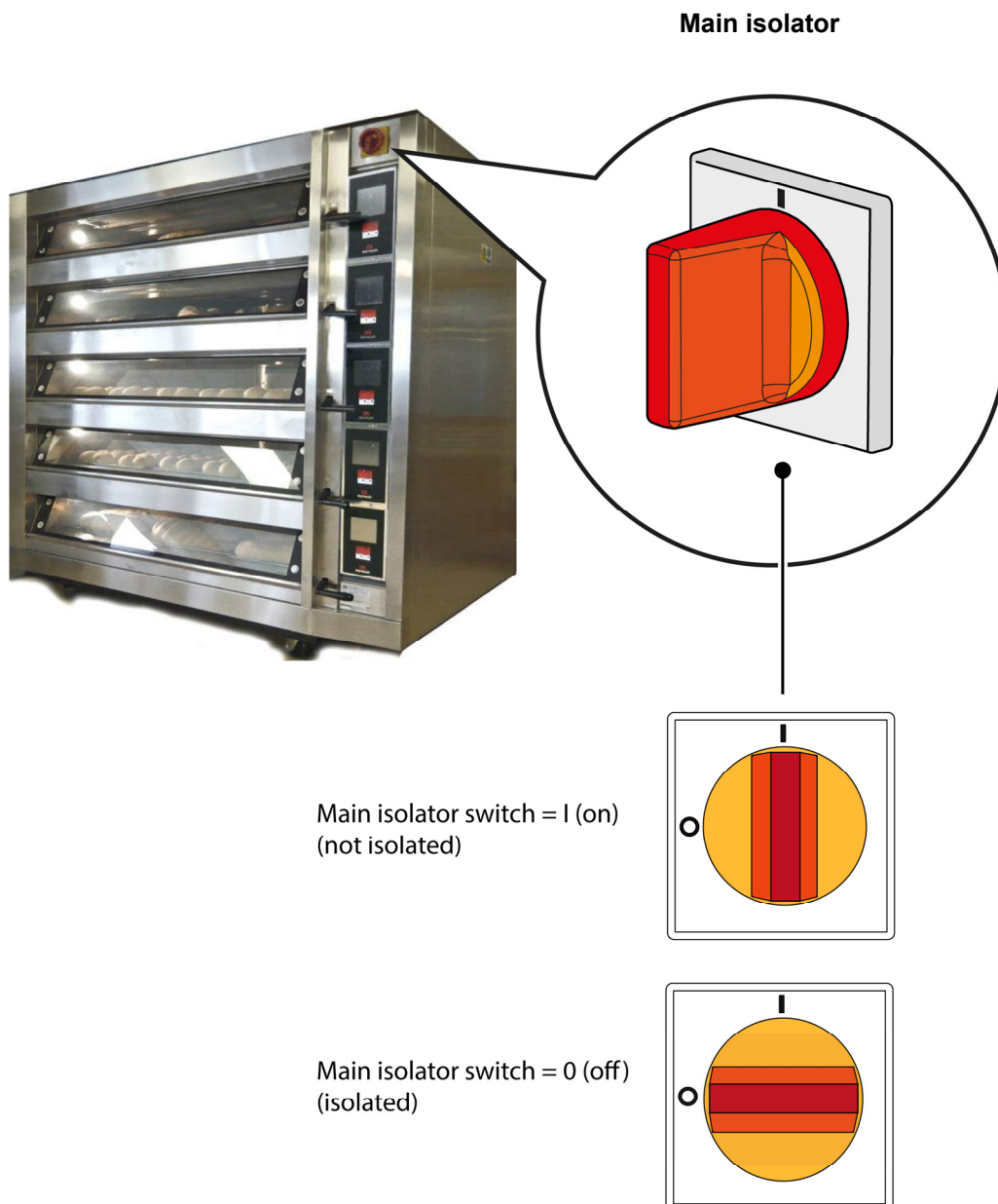

## 6. Cleaning

### Daily cleaning instructions



Isolate the oven from the mains supply before cleaning.



Take care water does not enter the control-panel mounting or roof-mounting fan.

#### Procedure

1. Sweep any debris out of the oven and prover **after** they have been allowed to cool.  
**Note:** Use a vacuum cleaner with metal attachments (i.e., able to take the heat), if available.
2. Brush and scrape off any flour and dough adhering to the prover cabinet inner surfaces. Use only a stiff brush or plastic scraper.
3. Brush down and wipe oven front, back and sides with a damp cloth.
4. Spot clean outside with a damp cloth, which has been soaked in a solution of mild detergent, and hot water, paying particular attention **to ensure excess water is not applied around the area of the electrical panels and switches.**

### Weekly cleaning instructions



Isolate the oven from the mains supply before cleaning.



Take care water does not enter the control-panel mounting or roof-mounting fan.



Do not stand on the roof.

#### Procedure

1. Complete the daily cleaning procedure, as above.
2. Use a nylon brush to scrub the wheels with a mild detergent and hot water.  
**Note:** Using too much water eventually rusts the metalwork.
3. Ensure the oven roof area is clear of debris and dust build-up.

## 7. Operating Conditions

- Leave a clear space of at least 2 metres (6 ft.) in front of the oven for ease of operation and safety reasons.
- Do not use bakery utensils to operate the control panel buttons.

## 8. Principal of Oven Operation

---

### NOTE

Operators should refer to their own company's recipe manual for the oven temperature settings.

---

### Baking heat

Products bake in an insulated, heated chamber with the temperature regulated by a thermocouple. A digital temperature read-out is visible on the control panel screen. Baking heat is radiant, with top and bottom heat adjustable by separate controls. This technology enables heat to be “balanced” according to product requirements.

### Steaming function

Steam is provided from an integral steam unit and injected into the chamber on demand. Programmed parameters automatically control this function.

***After being steamed, the oven does not allow more steaming until the steam unit has recovered heat, typically for 3 to 10 minutes, depending on the selected program.***

All deck ovens have a steam damper that evacuates steam humidity into a vent at the rear of the oven.

## Baking advice

### Advice for getting the best results from deck ovens:

#### Loading

1. **Do not place the products too close together.** *If the loaves are close to each other after the oven spring (expansion), it results in soft sides and may collapse on cooling.*
2. **Place the product evenly within the oven.** *Products bunched together are paler than those widely spaced.*
3. **Products should not be too close to the edge of the tile.** *As it expands towards the front, one side of the loaf may enter the cooler air by the door.*
4. **Door-opening should be kept to a minimum** *because cold air enters the oven. Cooling of the sidewalls and roof causes the finished product to be lighter locally at the front and wastes heat. If loading times are consistently long, alter the front-top heat to put more heat at the front.*
5. **The product can form a skin if the loading takes a long time,** *which causes an imbalance and a less attractive finish. By using the pre-steam function before loading, this can be minimised. The steam function turns the elements off and injects steam to increase the humidity.*

#### Bake settings

1. A good starting point for baking bread in Mono deck ovens is **225 °C (437 °F)**.  
**Top heat:** 60 to 65                      **Bottom heat:** 40
2. For cookies (and similar products), the oven's heat can be turned almost off. However, it may still be necessary to place the trays with, e.g. cookies, onto upturned trays on the oven sole.
3. **Steam** should be kept to a minimum for energy efficiency, depending on the product and finish. **Times of between 9 and 12 seconds should be adequate.** It is a good idea not to focus on the temperature recovery – this can vary from oven to oven.

### Is the product baked in the time and to the quality you require?

*Below are some tips for modifying the bake to get the product that you require.*

- If your product is **light on top**, decrease the bottom heat and extend bake time or increase the top heat.
- If the product **sides are pale** and the **top dark**, space the products well apart, drop the top heat, and extend the bake time.
- **If the bake time is too long**, first increase the top heat to speed recovery. If this does not give sufficient savings, increase the baking temperature.
- **To thicken the crust**, set the damper to be open for longer. Different ovens require different lengths of time.

## 9. Operating Instructions

Each deck has an independent LED screen for operating the oven.

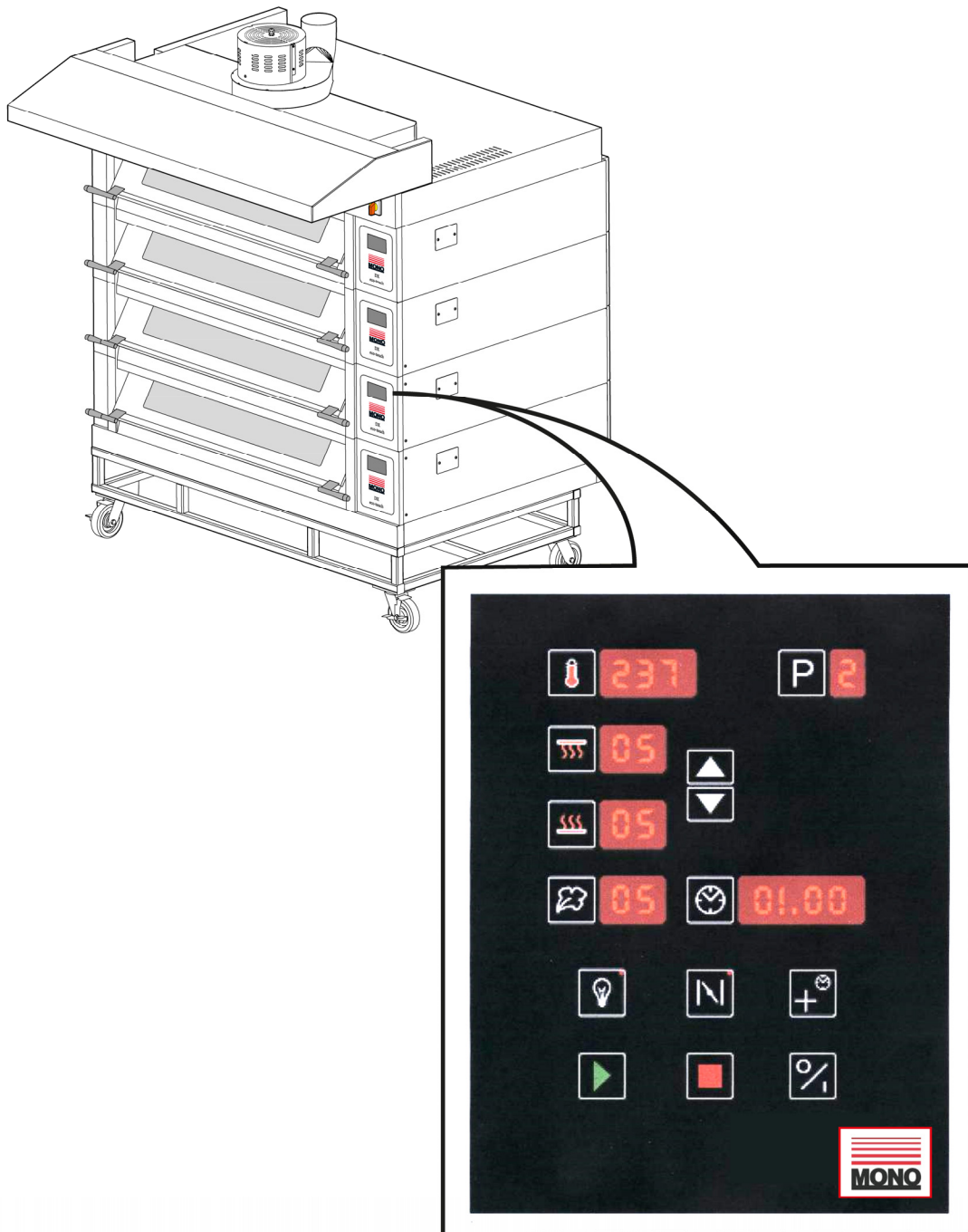

## Basic operation

Perform operations by touching icons on the screen.

**Figure 4:** Classic LED screen icons

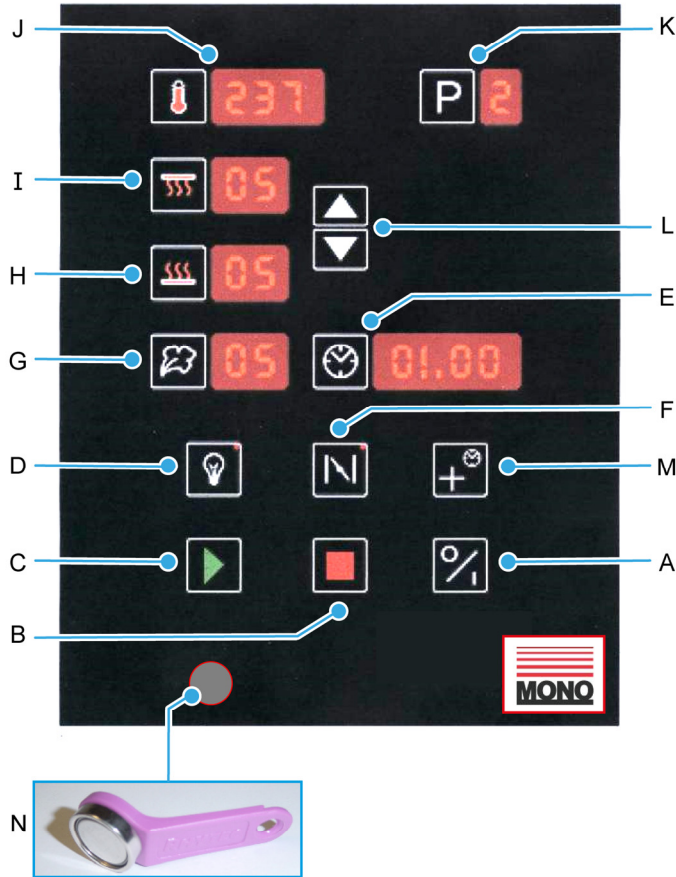

- |                       |   |                           |
|-----------------------|---|---------------------------|
| <b>A.</b> ON/OFF      | <b>B.</b> STOP                              | <b>C.</b> START           |
| <b>D.</b> LIGHT       | <b>E.</b> AUTO-ON SET / ADD TIME            | <b>F.</b> DAMPER          |
| <b>G.</b> STEAM TIME  | <b>H.</b> BOTTOM HEAT                       | <b>I.</b> TOP HEAT        |
| <b>J.</b> TEMPERATURE | <b>K.</b> PROGRAM                           | <b>L.</b> UP/DOWN BUTTONS |
| <b>M.</b> BAKE TIME   | <b>N.</b> iButton STORAGE DEVICE CONNECTION |                           |

**ON/OFF button (A)**

This button turns the controller on from standby mode. Also, used to exit setup mode.

**STOP button (B)**

This button stops the bake cycle. Also, use with button **C** to navigate to a function setup menu on power-up (with button **C**).

**START button (C)**

This button starts a bake cycle. Use with button **B** to navigate to a setup menu on power-up. Also, it silences the “2 minutes from the end-of-bake” alarm when sounding.

**LIGHT button (D)**

Interior light on/off.

- A red light shows when the light is on.
- Press to turn on, and press again to turn off.

**BAKE TIME/ADD TIME button (E)**

This button accesses the set bake time and the current time and day setup. Also, for navigating the day/hours/minutes when setting time and setting auto on time.

If the 7-DAY TIMER is enabled:

- During a bake cycle, use this button to add extra bake time (+1 minute for each press).
- At the end of a bake, press for two minutes and then once for each extra minute required.

**DAMPER button (F)**

Press to open the Damper, and press again to close the Damper. (It only works during a bake). Closes when stop pressed at the end of bake and while steaming. A red light shows when in the open position.

**STEAM TIME button (G)**

Press to access steam time and pre-steam mode.

If the pre-steam function is enabled:

- Press once (red dots appear). Use the UP/DOWN buttons (L) to change to the required setting. **P0** = no pre-steam, **P1** = 1 second, and **P2** = 2 seconds.
- Press again to set the steam time using the UP/DOWN buttons (L).
- Press the button again to save or wait 10 seconds to auto-save.

If the pre-steam function is not enabled:

- Press to set the steam time using the UP/DOWN buttons (L).
- Press the button again to save or wait 10 seconds to auto-save.

## **BOTTOM HEAT (H)**

Press to set the bottom heat cycle percentage. Use the UP/DOWN buttons (L) to adjust the value. Press the button again to save or wait 10 seconds to auto-save.

## **TOP HEAT (I)**

Press to set the top heat cycle percentage. Use the UP/DOWN buttons (L) to adjust the value. Press the button again to save or wait 10 seconds to auto-save.

## **TEMPERATURE (J)**

Press to set the baking temperature required. Use the UP/DOWN buttons (L) to adjust the value. Press the button again to save or wait 10 seconds to auto-save.

## **PROGRAM (K)**

Use the UP/DOWN buttons (L) for cycling to the required program.

To save the current settings, press and hold the P button for 5 seconds. All the displays will flash, and a beep confirms the saved settings.

## **UP/DOWN BUTTONS (L)**

Press to adjust values when required.

## **AUTO ON SET / ADD TIME (M)**

If the 7-DAY TIMER is enabled:

- Use the button to access auto-switch-on times.

If the 7-DAY TIMER is disabled:

- During a bake cycle, use this button to add extra bake time (+1 minute for each press).
- At the end of a bake, press for two minutes and then once for each extra minute required.

## **iBUTTON CONNECTION (N)**

MONO engineers use this button and a unique “iButton” storage device to change the firmware of the oven. See the next page for details.



# Firmware update using the i-BUTTON

## Firmware update procedure

1. Place the deck into the standby state (clock displaying).
2. Place iButton onto the probe ([Figure 4 | N](#)).

The controller now uploads data from iButton. During this process, a bake temperature window displays a countdown (going from 128 to 0) as data is uploaded.

The top heat window displays the number of failed reads from the iButton. If this count reaches 08, the upload terminates (see Error conditions below).

After the data has been uploaded and checked, the controller enters a programming state. The bake temperature window now displays **Prg**. This process should take approximately 8 seconds to complete.

---

### NOTE

During this programming phase, do not disconnect the power to the oven or remove the i-button from the reader probe. If the power is interrupted, the re-programming of the Flash memory will be incomplete, and the controller ceases to function. The only way to recover from this is to re-program the unit via a PC with a programming cable.

---

When the programming update is complete, the controller resets and displays the new firmware version in the time window. The display shows the firmware version continually until disconnecting the i-Button from the oven. After disconnection, the controller displays the clock and functions as usual.

## Error conditions

If an upload fails, the bake temperature window displays errors as codes. No changes to the oven are applied when there is an upload error. Firmware is only updated if the upload from the i-Button has been successful.

If an error is displayed, the oven waits for disconnection of the i-Button before resetting and functioning as usual. An upload (firmware update) can then be re-attempted.

If the i-Button is disconnected whilst uploading is in progress, the upload terminates and the oven resets.

### E01

If the controller fails to read the i-Button successfully eight times (in succession), **E01** appears in the bake temperature window. This error may be due to poor contact between the probe and the iButton, or bad data on the iButton. Try cleaning the surface of the probe – any small debris can affect the connection.

### E02

This error appears if the file information on the i-Button is incorrect or the i-Button is blank (unprogrammed).

### E03

This error appears if the iButton file CRC (cyclical redundancy check) does not match that calculated by the controller after a download, i.e. a corrupted iButton file.

## Operating the oven

1. With the oven in standby mode (power on), press the **ON** button (Figure 5 | A).

2. Press **P** (program) button (Figure 5 | K).

3. Using the **UP/DOWN** buttons (Figure 5 | L), choose the set program required.

The oven now heats to the temperature required. It is ready for use when the display shows the temperature of the program chosen and, if steam is needed, the display stops flashing.

4. Load the oven as required.

To preserve heat, do not leave doors open more than needed to load the oven.

5. Press the **START** button (Figure 5 | C).

Press the **BAKE TIME** button (Figure 5 | M) at any time during the baking to add 1 minute to the bake time.

If required during the bake, press the **DAMPER** button (Figure 5 | F) once to open the Damper, and press it again to close. A red light shows when the Damper is in the open position. If left open for 90 minutes, it closes automatically).

6. If enabled in the oven setup, a buzzer sounds for 10 seconds when the baking is 2 minutes from completion.

Press the **START** button to silence the buzzer.

7. At the end of the bake, the buzzer will sound.

Press the **STOP** button (Figure 5 | B) to silence the buzzer.

8. **If requiring extra baking at the end of a bake:**

(a) Press the **BAKE TIME** button to set 2 minutes and 1 minute for each additional press.

(b) After selecting the extra time, press the **START** button or wait 5 seconds for the bake countdown will start automatically.

---

### NOTE

Steam is not available when using this extra time baking.

---

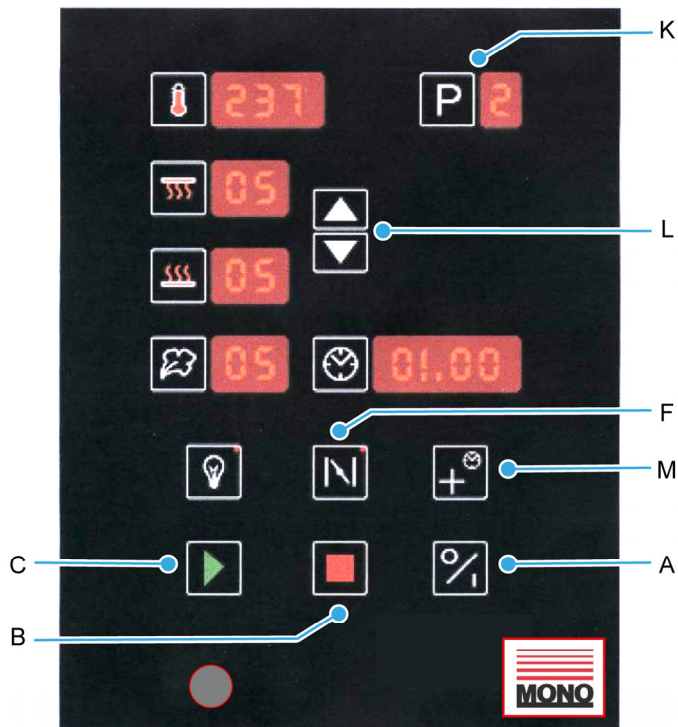
**Figure 5:** Operating the oven – Classic LED screen icons

## Setting the day and time

1. Turn the power supply on.  
This will put the oven in “standby mode” with only the clock showing.
2. Press the **CLOCK** button (**Figure 6 | E**) and dots will flash under the hours in the time window.  
Change the hours using the **UP/DOWN** buttons (**Figure 6 | L**).
3. Press the **CLOCK** button again and dots will flash under the minutes in the time window.  
Change the minutes using the **UP/DOWN** buttons (**Figure 6 | L**).
4. Press the **CLOCK** button again and the day number will show.  
Change the minutes using the **UP/DOWN** buttons (**Figure 6 | L**). Usually, day 1 is used as Monday.
5. Press the **CLOCK** button within 5 seconds to save the settings.

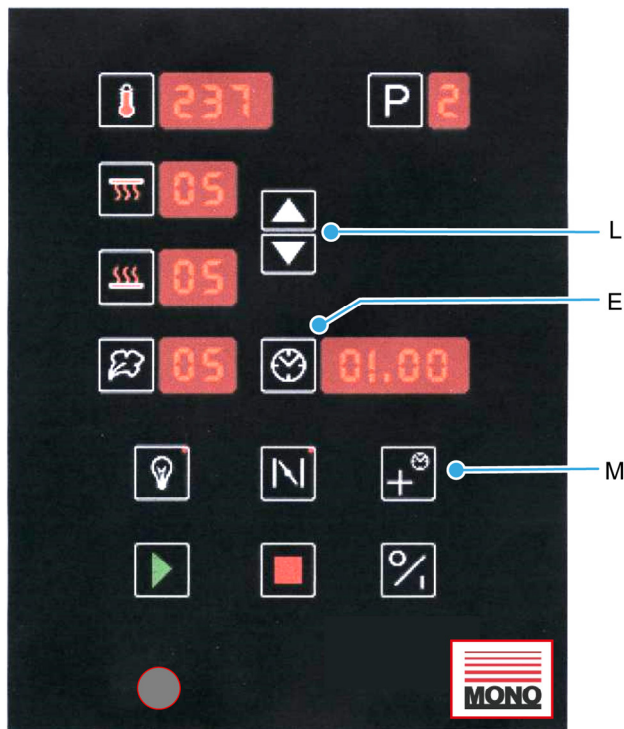
**Figure 6:** Setting the day and time – Classic LED screen icons

## Setting the 7-day timer

### NOTE

Enable F15 in the setup for the 7-day timer to function.

### Procedure for setting a timer event

1. Press the **I/O** button to put the controller into standby mode.  
Only the current time is displayed in the bake time window.
2. Press the **BAKE TIME** button (Figure 6 | M).  
The day of the week appears in the P window (and dots appear next to the day).  
Press the **UP/DOWN** button (Figure 6 | L) to change the day number.
3. Press the **CLOCK** button (Figure 6 | E) and dots appear under the hours in the time window.  
Change the hours using the **UP/DOWN** buttons (Figure 6 | L).
4. Press the **CLOCK** button (Figure 6 | E) again and dots appear under the minutes in the time window.  
Change the minutes using the **UP/DOWN** buttons (Figure 6 | L).
5. Press the **BAKE TIME** button (Figure 6 | M) to save and exit the timer setup.

**NOTE**

If you do not alter the hours and minutes within 6 seconds, the timer setup defaults back to day setting. Dots appear next to the P window. Just press the **BAKE TIME** button to return to the time setup again. Setting a time of 00.00 in the timer setup is a non-event so will not switch on the controller.

**Setup mode**

1. To enter setup mode, press and hold the **START** button (Figure 7 | A) and **STOP** button (Figure 7 | B) at the same as turning on the power supply.
2. Change the function in the temperature window (Figure 7 | C) using the **UP/DOWN** buttons (Figure 7 | D).  
See the next page for a function list.
3. Press the **CLOCK** button (Figure 6 | E) – dots appear on the display.
4. Change the setting for the function using the **UP/DOWN** buttons (Figure 7 | D).
5. Press the **CLOCK** button (Figure 6 | E) to save the setting for that function.
6. Repeat steps 2 to 5 for each function to be changed.
7. Press the **ON/OFF** button (Figure 6 | F) to exit setup mode.

**NOTE**

Any changes to the functions are only saved when exiting using **ON/OFF** button.

**Figure 7:** Setup mode – Classic LED screen icons

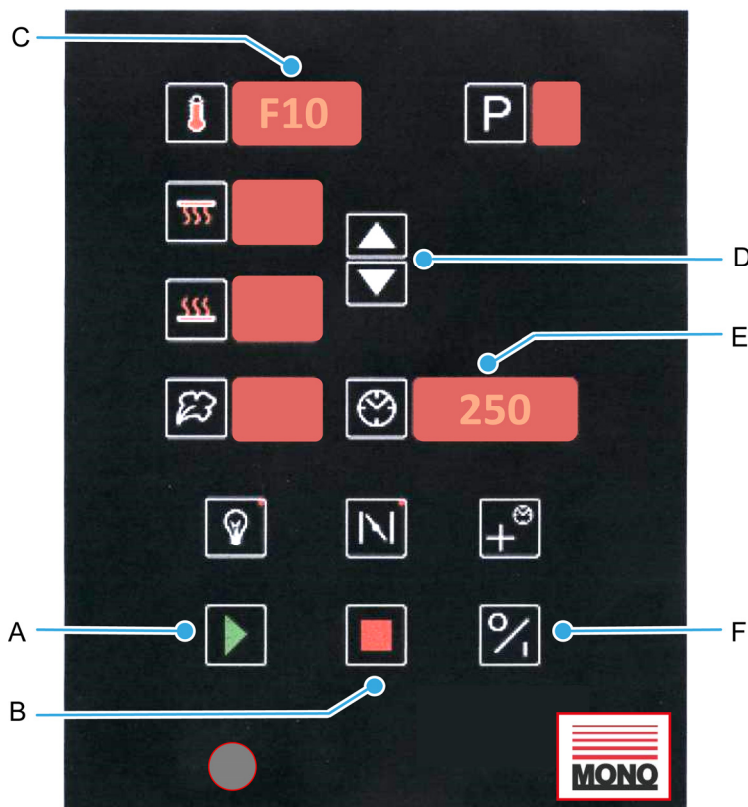

**Table 2:** Parameter function list

ID	Function description	Default setting
F1	MONO constant (factory set)	250
F2	Top heat gain	50
F3	Bottom heat gain	50
F4	Front-top element offset	25
F5	Deg "C", Deg "F" (0=C, 1=F)	0
F6	2 minute from end-of-bake alarm (Enable=1, Disable=0)	0
F7	Pre-steam (Enable=1, Disable=0)	0
F8	Steam (Enable=1, Disable=0)	0
F9	Bake temperature offset (+/- 25 Deg C)	25
F10	Maximum set temperature limit (Deg C)	250
F11 <sup>(1)</sup>	Bake controls lockout (Enable=1, Disable=0)	0
F12	Sleep mode delay time (60 minutes maximum; Disable=0)	0
F13	Interior light auto-timeout – ON/OFF (1 to 20 minutes; Disable=0)	0
F14	0-9 Program	0
F15 <sup>(2)</sup>	7-day time (Enable=1, Disable=0)	0
F16 <sup>(3)</sup>	9 hour countdown timer (Enable=1, Disable=0)	0
F17	Lamp output soft start (Enable=1, Disable=0)	0

<sup>(1)</sup> To prevent an operator from changing the set bake parameters.

<sup>(2)</sup> If enabled, the "SET BAKE" time acts as an extra time button. If disabled, "AUTO ON SET" acts as an extra time button.

<sup>(3)</sup> After 8 hours, the oven turns itself off (not during a bake cycle). Before going off, displays flash and an alarm sound. At this point, pressing any button adds an extra hour to the time.

## NOTE

After switching on the controller, before the sleep delay time is initiated (if enabled in **F12**), the set bake temperature must be reached, steam recovery time elapsed, and a bake cycle started and stopped.

After the **STOP** button has been pressed at the end of a bake, the sleep delay timer counts down until it reaches 0. At this point, the controller switches into sleep mode (**SLP** displayed in temperature window) and the oven will drop to a pre-set fall-back temperature of 170°C (338°F), which it will maintain.

Be aware that the damper closes when oven goes into sleep mode.

Pressing any button during the sleep mode delay time will not affect the countdown, apart from the **ON/OFF** button which switches the controller off. Pressing the **START** or **STOP** buttons resets the countdown timer.

Pressing any button while in sleep mode (except the **LIGHT** button – which operates as normal – and the panel **ON/OFF**) brings the controller out of sleep mode. The oven then heats up to its previous set bake temperature. A typical recovery time from 170°C to 230°C (338°F to 446°F) is approximately 15 minutes.

Be aware that if no buttons on the controller are pressed after exiting sleep mode, the controller returns to sleep mode after the sleep delay time has expired.

## 10. Troubleshooting

### None of the decks switched on

- Is the oven's main isolator set to the on (I) position?
- Check if a time clock of the bakery's mains power supply is working (if fitted).
- Is the clock set correctly to power the oven at the required day and time?

### One deck has not switched on

- Check if the individual deck timer is to come on at a specific time.

### Uneven or patchy bake

- The deck door is open too often or too long whilst loading (front pale, back burnt).
- Uneven loading.
- Faulty element.
- Top or bottom deck elements are not functioning.
- No supply voltage across a phase.

### Actual temperature is far exceeding the set temperature

When empty, the temperature of a deck oven can exceed the set baking temperature. This overheat is marginal when the deck is full of product. If the elements are continuing to work after the set temperature has been reached, call MONO service.

(Please allow up to 15 °C (59 °F) difference before diagnosing a fault condition).

### Poor recovery of actual temperature after loading

- Doors may have been left open too long during loading, allowing heat to escape.
- Damper may have been left open during loading/baking, allowing heat to escape.
- Top or bottom heat may not be working.
- No supply voltage across a phase.

### Steam system not operating correctly

- Is water connected correctly?
- Is the tap to each deck in the on position?
- Has enough time elapsed since the last steaming?

Once steamed, the oven does not steam until the steam unit has recovered heat, typically 3 to 10 minutes depending on the program selected.

# 11. Service and Spares

## Service information

If a fault arises, please do not hesitate to contact the MONO Customer Service Department. Quote the machine serial number on the silver information plate of the machine and on the front cover of this manual.



## MONO Equipment

Queensway, Swansea West Industrial Park, Swansea, SA5 4EB UK

**Tel. 01792 561234**

Spares +44(0)1792 564039

Email: [mono@monoequip.com](mailto:mono@monoequip.com)

**[www.monoequip.com](http://www.monoequip.com)**

## Disposal

When the oven comes to the end of its working life, dispose of parts in the appropriate place by recycling or other means as the law permits at that time.



## 12. Maintenance

### General maintenance

---

**WARNING**

- This appliance must be maintained at regular intervals. The frequency of maintenance will depend upon your specific use and location. The maximum service interval should be 12 months.
  - Service and maintenance should only be undertaken by suitably qualified, trained, and competent engineers.
  - You must immediately report any damage or defect arising with the appliance.
  - Unsafe equipment is dangerous. Do not use the appliance. Isolate the power supply and contact **MONO** or your appointed service agent.
- 

- Check for frayed or bare cables.
  - **Do not** use the machine if frayed or bare cables are visible.
- Follow cleaning instructions (see **Cleaning** on page 18).

# 13. Electrics

**Table 3:** Parts list for the MONO DX2 LED Deck Oven

Reference in drawing	Description	Part number
F1	Heater MCB	B872-22-008
F2	Heaters MCB	B872-22-008
F3	Heaters MCB	B872-22-008
F4	Control power supply MCB	B872-22-063
F5	Overheat thermostat	B888-30-014
F6	Cooling fan MCB	B872-22-061
T1	Control circuit power supply	B801-93-004
K1	Top heat contactor	B801-08-021
K2	Bottom heat contactor	B801-08-021
Y1	Water solenoid (8 mm pipe)	B867-83-007
Y2	Damper solenoid	B749-83-004
Q1	Mains isolator	B851-07-002
R1	Top heat element, 1.0 kW	B854-04-003
	Top heat element, 1.0 kW (220 Vac)	B854-04-012
R2	Top heat element, 0.6 kW	B854-04-004
	Top heat element, 0.6 kW (220 Vac)	B854-04-013
R3	Top heat element, 0.6 kW	B854-04-004
R4	Top heat element, 0.6 kW	B854-04-004
R5	Top heat element, 0.6 kW	B854-04-004
R6	Top heat element, 0.6 kW	B854-04-004
R7	Top heat element, 0.44 kW	B854-04-036
	Top heat element, 0.44 kW (220 Vac)	B854-04-045
R8	Bottom heat element, 1,0 kW	B854-04-003
	Bottom heat element, 1,0 kW (220 Vac)	B854-04-012
R9	Bottom heat element, 0.6 kW	B854-04-004
	Bottom heat element, 0.6 kW (220 Vac)	B854-04-013
R10	Bottom heat element, 0.6 kW	B854-04-004
R11	Bottom heat element, 0.6 kW	B854-04-004
R12	Bottom heat element, 0.6 kW	B854-04-004
R13	Bottom heat element, 0.6 kW	B854-04-004
R14	Bottom heat element, 0.6 kW	B854-04-004

IF IN ANY DOUBT - ASK

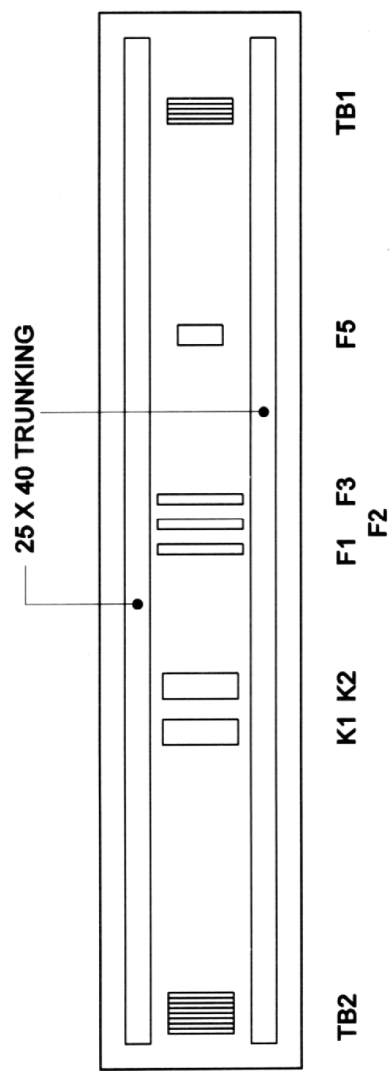

REV	SIG	DATE	REVISION	ECN NO.
			<b>RIGID DX OVEN LCD CONTROL PANEL LAYOUT</b>	
		<b>MONO EQUIPMENT</b> QUEENSWAY SWANSEA WEST IND PARK SWANSEA, SA5 4EB. TEL: (01792) 561234 FAX: (01792) 561016	TITLE: <b>RIGID DX OVEN LCD CONTROL PANEL LAYOUT</b>	
ELECTRICAL SPECIFICATIONS:- <b>415V 3 PHASE + N</b>			DRAWN: RAC AT	ELECTRICALLY APPROVED BY:-
DATE: 30/11/05			DRAWING NO. <b>M245E25-50314</b>	REV: --

COPYRIGHT © 1998 - THIS DESIGN/DRAWING IS THE PROPERTY OF MONO EQUIPMENT LTD. AND MUST NOT BE REPRODUCED, COPIED, NOR ITS CONTENTS DIVULGED WITHOUT PRIOR WRITTEN PERMISSION.

**Figure 8:** Controller layout

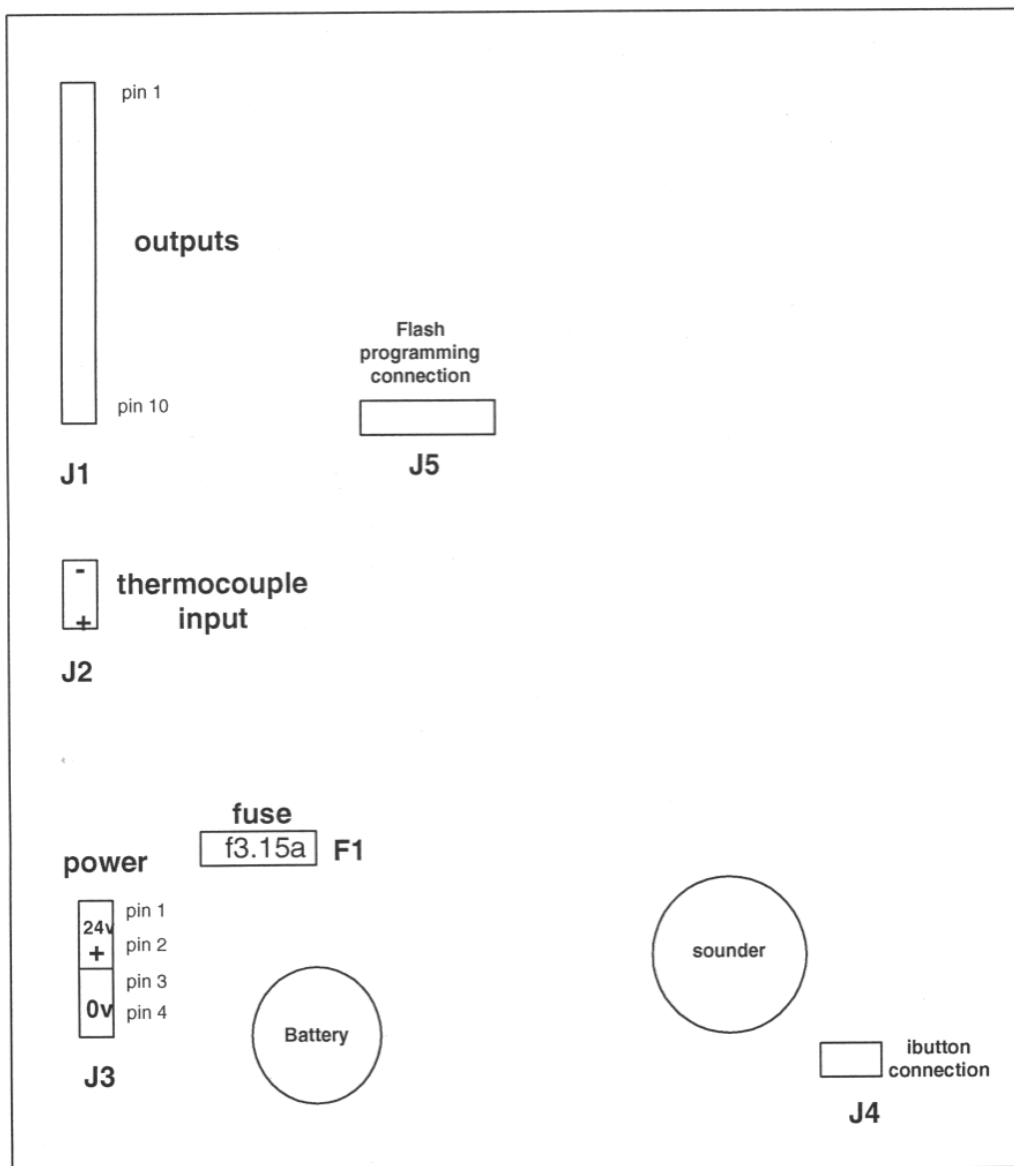

**OUTPUTS**

- PIN 1 – 24v
- PIN 2 – TOP HEAT OUTPUT
- PIN 3 – TOP FRONT HEAT OUTPUT
- PIN 4 – BOTTOM HEAT OUTPUT
- PIN 5 – STEAM OUTPUT
- PIN 6 – DAMPER OUTPUT
- PIN 7 – LIGHT OUTPUT
- PIN 8 – CANOPY FAN RELAY OUTPUT
- PIN 9 – 24v
- PIN 10 – 24v



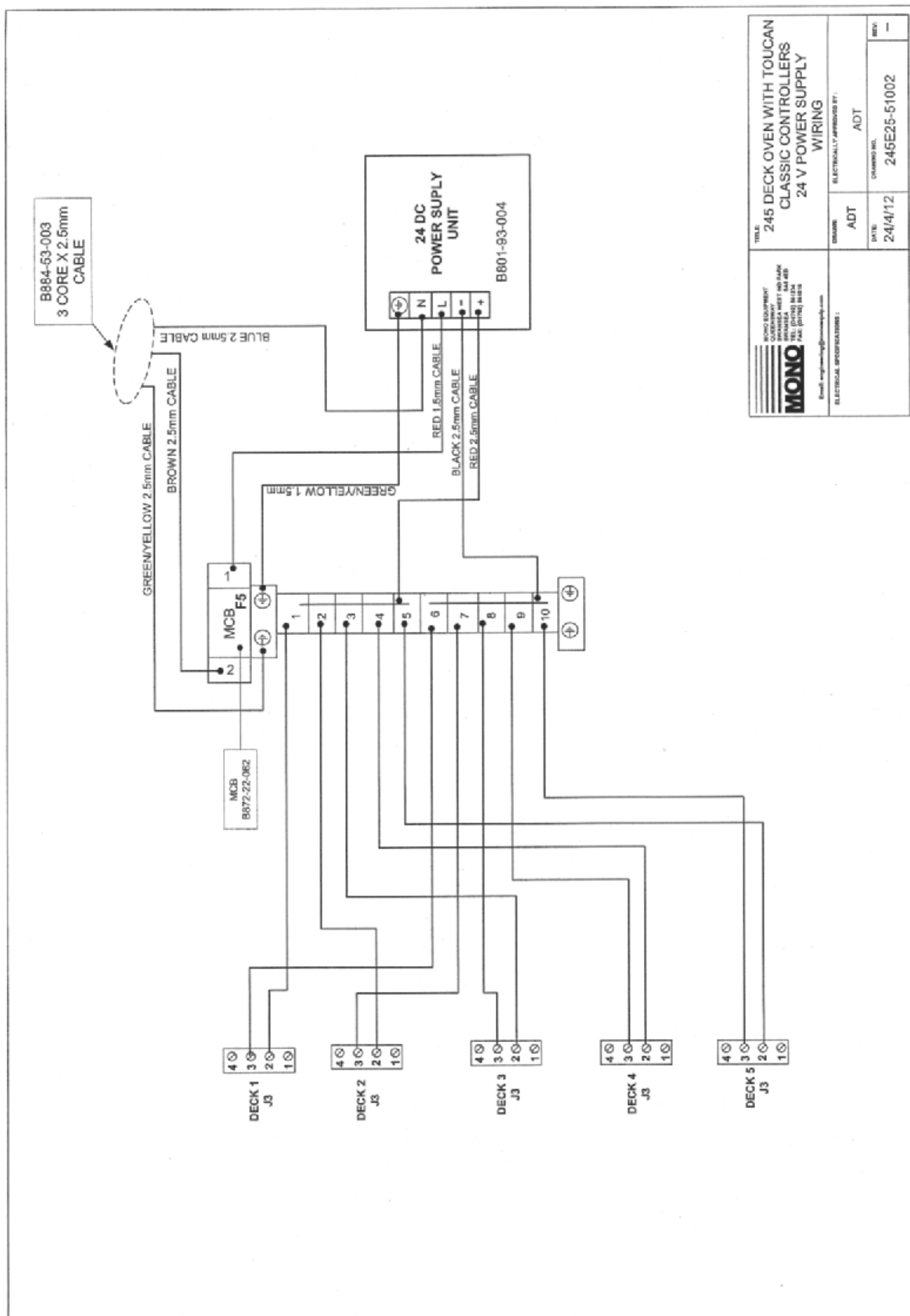

<p>MONO EQUIPMENT CONTRACTORS LTD BRANDS P.O. BOX 100 WALSLEY S68 7LN TEL: 01924 454545 FAX: 01924 454546 Email: enquiries@mono-equip.com</p>	<p><b>TITLE:</b> 245 DECK OVEN WITH TOUCAN CLASSIC CONTROLLERS 24 V POWER SUPPLY WIRING</p>	
	<p><b>DATE:</b> 24/4/12</p>	<p><b>DRAWING NO.:</b> 245E25-51002</p>
<p><b>DESIGNED BY:</b> ADT</p>		<p><b>ELECTRICALLY APPROVED BY:</b> ADT</p>
<p><b>ELECTRICAL SPECIFICATIONS:</b></p>		<p><b>REV:</b> —</p>

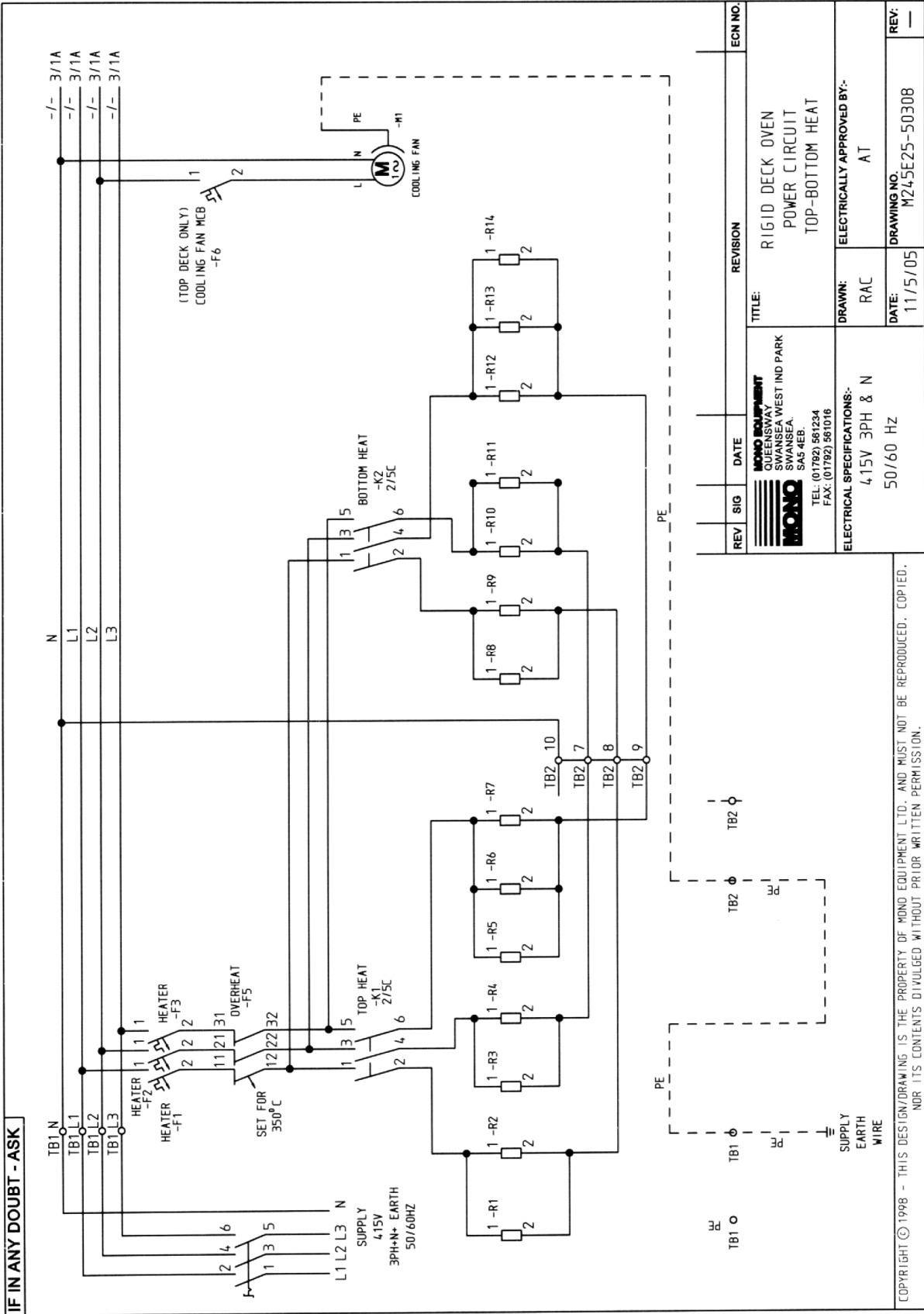

REV	SIG	DATE	REVISION	ECN NO.

<p><b>MONO EQUIPMENT</b> QUEENSWAY SWANSEA WEST IND PARK SWANSEA, SA5 4EB. TEL: (01792) 561234 FAX: (01792) 561016</p>	<p><b>TITLE:</b> RIGID DECK OVEN POWER CIRCUIT TOP-BOTTOM HEAT</p>
<p><b>DRAWN:</b> RAC</p> <p><b>DATE:</b> 11/5/05</p>	<p><b>ELECTRICALLY APPROVED BY:-</b> AT</p>

<p><b>ELECTRICAL SPECIFICATIONS:-</b> 415V 3PH &amp; N 50/60 Hz</p>	<p><b>DRAWING NO:</b> M245E25-50308</p>
---	---

COPYRIGHT © 1998 - THIS DESIGN/DRAWING IS THE PROPERTY OF MONO EQUIPMENT LTD. AND MUST NOT BE REPRODUCED, COPIED, NOR ITS CONTENTS DIVULGED WITHOUT PRIOR WRITTEN PERMISSION.

IF IN ANY DOUBT - ASK

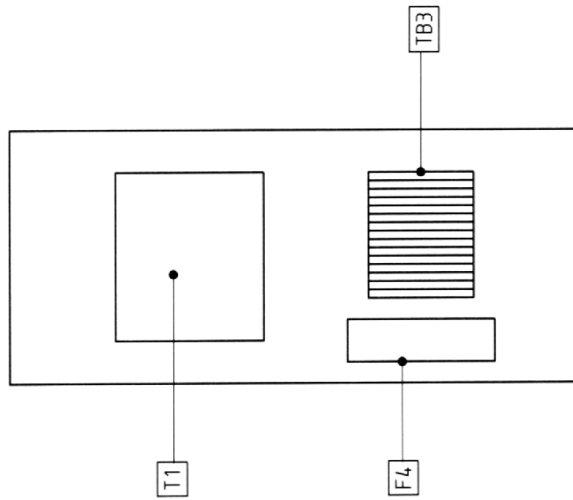

COPYRIGHT © 1998 - THIS DESIGN/DRAWING IS THE PROPERTY OF MONO EQUIPMENT LTD. AND MUST NOT BE REPRODUCED, COPIED, NOR ITS CONTENTS DIVULGED WITHOUT PRIOR WRITTEN PERMISSION.

REV	SIG	DATE	REVISION	ECN NO.
		<b>MONO EQUIPMENT</b> QUEENSWAY SWANSEA WEST IND PARK SWANSEA, SA5 4EB. TEL: (01792) 561234 FAX: (01792) 561016	TITLE: RIGID DECK OVEN POWER SUPPLY UNIT LAYOUT	
ELECTRICAL SPECIFICATIONS:- 415v 3 PHASE + N		DRAWN: RAC	ELECTRICALLY APPROVED BY:- AT	
		DATE: 6/12/05	DRAWING NO. M245E25-50313	REV: --



**ELECTRICAL CONNECTIONS FOR ADDING CANOPY TO FG245 DECK OVEN**

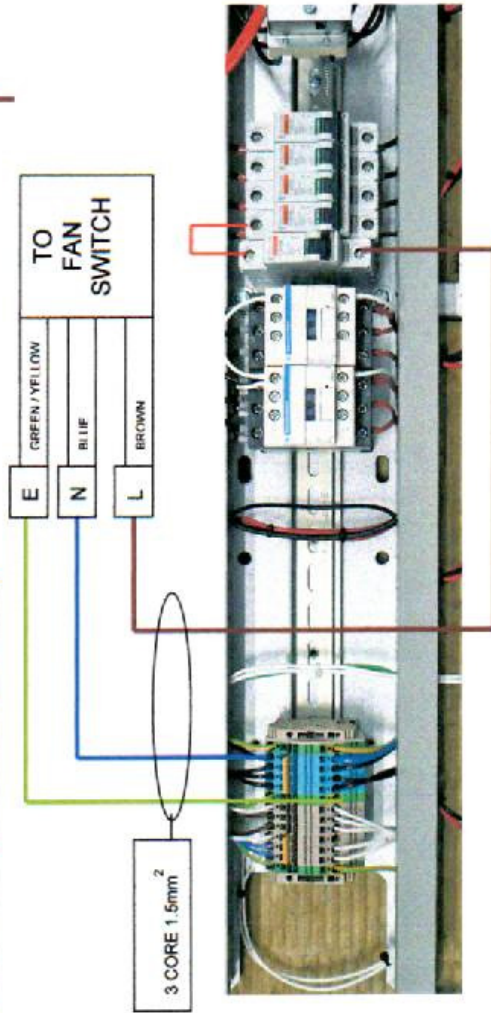
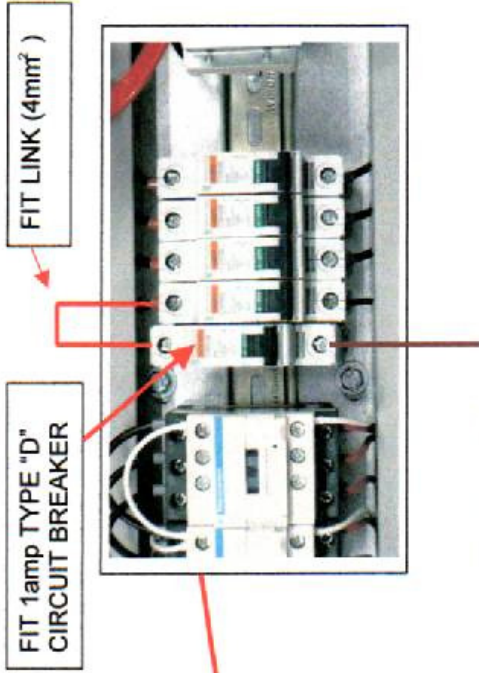
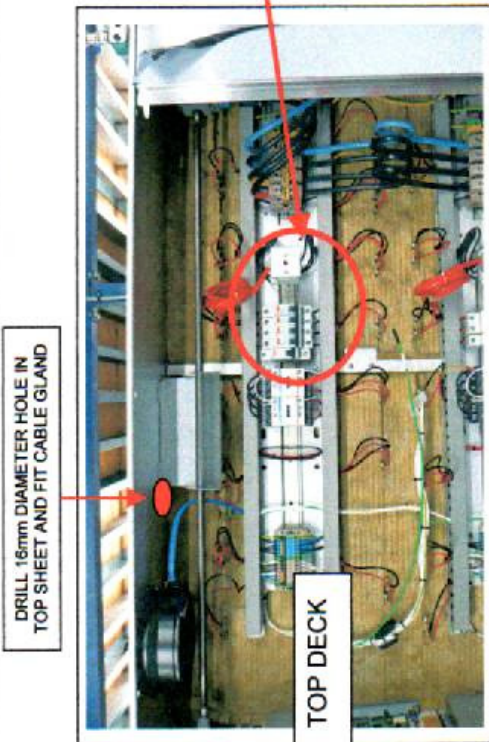

CANOPY IF FITTED

**WARNING** ISOLATE OVEN FROM POWER SUPPLY BEFORE REMOVING SIDE PANEL AND WORKING ON ELECTRICS

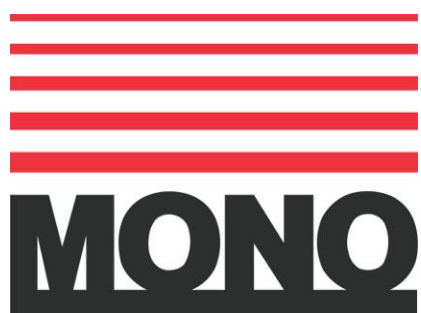

**MONO Equipment**

Queensway, Swansea West Industrial Park, Swansea, SA5 4EB UK

Tel. 01792 561234

Spares +44(0)1792 564039

Email: [mono@monoequip.com](mailto:mono@monoequip.com)

**[www.monoequip.com](http://www.monoequip.com)**

As it is our policy to improve our machines continuously, we reserve the right to change specifications without prior notice.